



Department of Computer Science and Engineering  
計算機科學與工程學系

---

# Computer Science and Engineering (JS4412 / BCSEN)

---



# Agenda

1. Introduction of our Department
2. Introduction of BCSE Programme
3. Admission Requirements
4. Curriculum Structure
5. FAQ

# Department of Computer Science and Engineering



# A Long History

- The first computer science department in HK
- Offering **AIST**, **CDAS**, **CENG** and **CSCI** programmes
- A strong alumni network

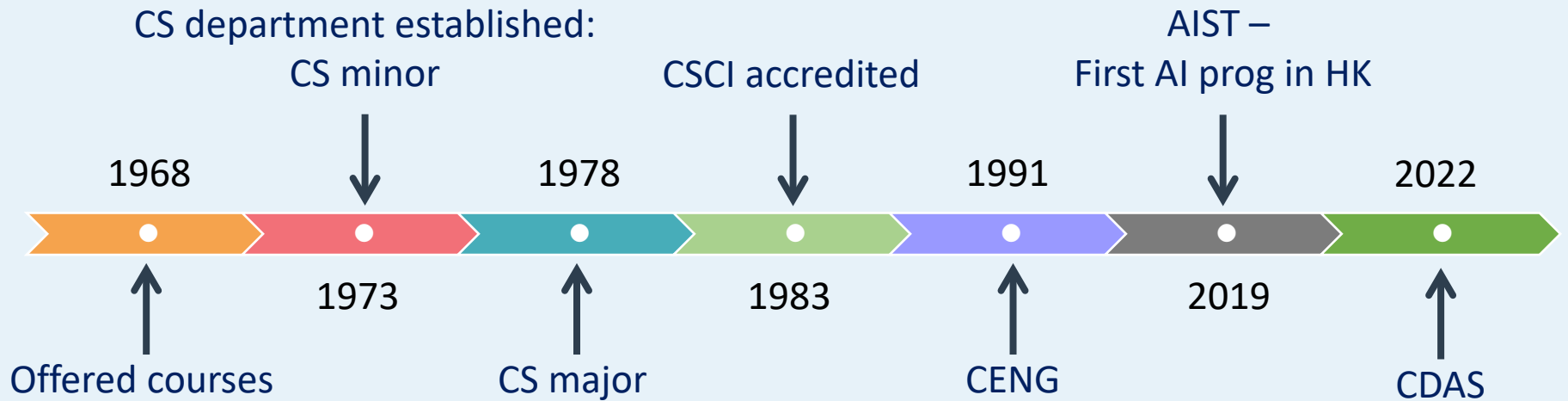

# Our Undergraduate Programmes

**Department of Computer Science and Engineering (CSE)**

**Artificial Intelligence:  
Systems and  
Technologies  
(AIST)**

**Computer Science  
and Engineering  
(BCSE)  
(Foundation 1<sup>st</sup> year)**

**Computational Data  
Science  
(CDAS)  
(Joint Programme with  
Department of Statistics)**

**Computer  
Engineering  
(CENG)**

**Computer  
Science  
(CSCI)**

# Excellent Teaching and Research Team



- **2021 Kyoto Prize Laureate and Turing Award Recipient**

Prof. Andrew Yao

- **7 ACM Fellows**

Prof. Benjamin Wah, Prof. John Lui, etc.

- **13 IEEE Fellows**

Prof. Irwin King, Prof. Evangeline Young, Prof. Yufei Tao, etc.

- **2022 IEEE CEDA Ernest S. Kuh Early Career Award**

Prof. Bei Yu

- **Hong Kong Academy of Engineering Sciences Fellows 2021**

Prof. Michael Lyu

- **InnoStars Award 2021**

Prof. Jiaya Jia

- **Forbes 30 Under 30 Asia (Healthcare & Science Category) – Class of 2022**

Prof. Yu Li

- **Distinguished Fellow of the Hong Kong Computer Society 2022**

Prof. Jimmy Lee

# Rankings

Home / Education / Global Universities / Best Global Universities Rank... / Hong Kong / Artificial Intelligence

## Best Global Universities for Artificial Intelligence in Hong Kong

These are the top universities in Hong Kong for artificial intelligence, based on their reputation and research in the field. [Read the methodology »](#)

To unlock more data and access tools to help you get into your dream school, sign up for the [U.S. News College Compass!](#)

Summary ▾

f t p ...

4 schools [Clear Filters](#) [Hong Kong](#) [Artificial Intelligence](#)

SORT BY: Rankings (high to low)

School Name

Region

Country/Region

Canada China France Germany India Italy Japan Netherlands

**Chinese University of Hong Kong**

Hong Kong | Shatin

**#3 in Best Universities for Artificial Intelligence (tie)**

#52 in Best Global Universities

Subject Score: 91.3

Global Score: ---

[Read More »](#)

Global Universities / Best Global Universities Rank... / Hong Kong / Artificial Intelligence

US News and World Report:  
Best Universities in  
**Artificial Intelligence**  
2022-2023  
**#1** in Hong Kong  
**#3** Globally

US News and World Report:  
Best Universities in  
**Computer Science**  
2022-2023  
**#1** in Hong Kong  
**#10** Globally

Global Universities / Best Global Universities Rank... / Hong Kong / Computer Science

## Best Global Universities for Computer Science in Hong Kong

These are the top universities in Hong Kong for computer science, based on their reputation and research in the field. [Read the methodology »](#)

To unlock more data and access tools to help you get into your dream school, sign up for the [U.S. News College Compass!](#)

Summary ▾

f t p ...

6 schools [Clear Filters](#) [Hong Kong](#) [Computer Science](#)

SORT BY: Rankings (high to low)

School Name

Region

Country/Region

Canada China France Germany India Italy Japan Netherlands

**Chinese University of Hong Kong**

Hong Kong | Shatin

**#10 in Best Universities for Computer Science**

#33 in Best Global Universities

Subject Score: 86.8

Global Score: 74.7

Enrollment: 18,468

[Read More »](#)

Global Universities / Best Global Universities Rank... / Hong Kong / Computer Science

# Strong Alumni Network

## IT Industry



**NOKIA**



**facebook**

## Education

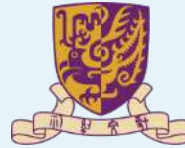

**NUS**  
National University  
of Singapore



**Georgia  
Tech**

## Banking



**citibank**

Morgan Stanley



Deutsche Bank

**Deloitte.**

**Goldman  
Sachs**



# Sharing from our CSE Alumni

I'm now working in Deloitte's Cyber Risk Advisory Team. Cybersecurity is a promising job, you can equip yourself to be a cybersecurity expert by enrolling relevant courses provided by the Department of Computer Science and Engineering. Cybersecurity professionals, like information security analysts, protect businesses, governments, and individuals from criminal activities on the internet. With the explosive growth of the internet in business, education, and personal communication, computer experts with knowledge of cybersecurity are in high demand.



**Ka Ki CHAU,**  
CSCI Graduate of 2021

# Sharing from our CSE Alumni



Hei Yiu LAW,  
CENG Graduate of 2021

During the 4 years of my study as a CENG student, I could take courses on different topics. These courses not only consolidate my knowledge related to my major but can also train up my critical thinking and logical thinking skills. We have to design and implement a smart hardware product in just a few weeks and this project not only gives me a hands-on experience on designing smart hardware product, but also improves my communication skill and time management skill.

# Recent Achievements in Intl'/Local Competitions

**Championship** in  
Robocon Hong Kong Contest 2022



Hong Kong Computer Society  
**Student Sponsorship** 2022



**First Prize** in the Cloud Track of the  
Huawei ICT Competition



# Industrial Visits

- Visit to companies to learn latest development in industry



# Work-Study Scheme

- One-year placement and internship for students to gain practical experience in a real working environment

## Example of Previous Opportunities in CSE



# What's More?

- Chances to **create your own project and innovation** with support and advice from CSE teachers
- **Exchange opportunities** to world-class universities
- **High competitiveness** in job market with **90%** of CSE graduates employed within one month of graduation
- CSE teachers usually have the **highest teaching evaluation scores**

# Computer Science and Engineering (BCSE) Programme

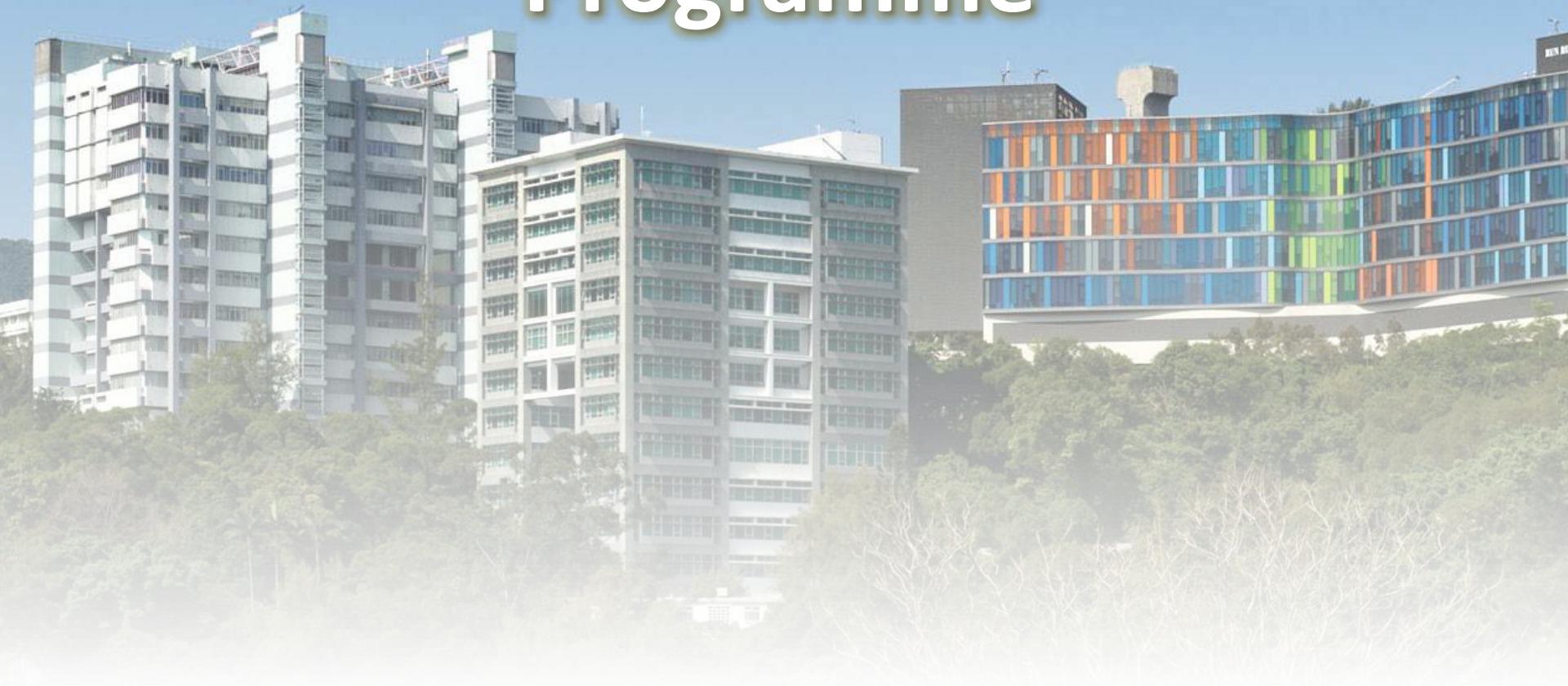

# Growing Demand and Opportunities

Due to the pandemic :

- workers going remote
- companies turning to e-commerce to survive,
- organizations needing to be more digitally agile
- Engineering is the fastest-growing field in the world
- 24 of 28 countries listed data engineer among its fastest-growing careers

Linkedin: The Fastest-Growing Jobs Around the World in 2023

(<https://www.linkedin.com/business/talent/blog/talent-acquisition/fastest-growing-jobs-2023>)



# Growing Demand and Opportunities

- Hong Kong's start-up ecosystem is **thriving**. In 2022, the number of start-ups in Hong Kong **grew by 6%** to 3,985, employing nearly 15,000 people.
- Biotechnology, **artificial intelligence**, smart city and financial technologies were identified as the four **key areas for Hong Kong's innovation and technology industry**.
- Hong Kong's innovation and technology sector together with that of Shenzhen and Guangzhou – the Shenzhen-Hong Kong-Guangzhou science and technology cluster – ranks as **the world's second performing** according to the Global Innovation Index 2023.

## Industry Data

Global Rankings	2019	2020	2021	2022
Global Innovation Index	11/131	14/132	14/132	17/132
IMD Digital Competitiveness	5/63	2/64	9/63	N/A

Source: Global Innovation Index Reports; IMD World Competitiveness Centre

# Things You Can Learn

- Artificial Intelligence
  - Teach computers to **think** better
  - Learning, vision, voice **recognition**
- Algorithms and Complexity
  - Find **the most efficient ways** to solve problems
  - Learn their **limitations**: things computers cannot do
- Systems and Networks
  - Find out how to build large services like Google and Facebook
  - Learn how **cloud computing** works

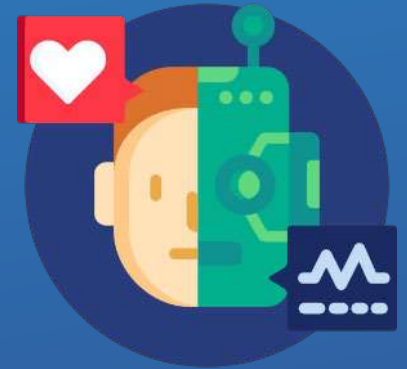

# Things You Can Learn

- Software Engineering
  - Learn how to **write** very big programme projects and test that they work properly
- Graphics and Multimedia Technology
  - Build exciting **new computer games**
- Cyber-security
  - Apply your knowledge of algorithms, systems, networks to make application **secure**



# Things You Can Learn

- VLSI and Embedded Systems
  - Design **smart, energy efficient** hardware devices
- Bioinformatics
  - Use **computers** to figure out microorganisms, genetics, and understand diseases
- Databases, Computational Finance, Control, ...  
... and much more

# Admission Arrangements and Requirements (First Year Entry)



# Admission Arrangements (First Year Entry)

- Students will first be admitted into the **Computer Science and Engineering (BCSE)** programme for a common 1st year of study
- They will then be allocated into either **Computer Engineering (CENG)** or **Computer Science (CSCI)** according to their CGPA after finishing their 1<sup>st</sup> year of study

# Admission Requirements (For JUPAS Applicants)

<b>HKDSE Subject</b>	<b>Minimum Level</b>	<b>Subject Weighting</b>
<b>HKDSE Core Subjects</b>		
English Language	3	1
Chinese Language	3	1
Mathematics (Compulsory Part)	4	1.5
Citizenship and Social Development	A (Attained)	-
<b>HKDSE Elective Subjects</b>		
One specific science subject <sup>^</sup>	3	1.5 – 1.75
Any one other subject <sup>#</sup>	3	1 – 1.75

<sup>^</sup> *Specific science subjects and subject weighting include 1.75 for Math M1/M2, 1.5 for Biology, Chemistry, and Physics, and Information and Communication Technology.*

<sup>#</sup> *Preferred subjects include 1.75 for Math M1/M2, 1.5 for Biology, Chemistry, Physics, Design and Applied Technology and Information and Communication Technology, and 1 for other subjects.*

*Selection is based on the Best 5 HKDSE subjects with subject weighting applied. Bonus points will be awarded to the 6<sup>th</sup> and 7<sup>th</sup> subjects, if any.*

# BCSE Admission Grades (2023 Entry)

Percentile	CHI	ENG	MATHS	LS	M1/M2	1 <sup>st</sup> Elective	2 <sup>nd</sup> Elective	3 <sup>rd</sup> Elective	2023 Programme Weighted Total <sup>^</sup>
Upper Quartile	5*	3	5*	3	5	5*	5	4	45.875
Median	5	4	5*	3	5*	5	4		42.5
Lower Quartile	3	5	5	2	5	5	5		39.875

<sup>^</sup> *Category A subjects score conversion scale: 5\*\* = 8.5 | 5\* = 7 | 5 = 5.5 | 4 = 4 | 3 = 3 | 2 = 2 | 1 = 1;*  
*Category C subjects score conversion scale: A = 5 | B = 4 | C = 3 | D = 2 | E = 1;*

*2023 Subject Weighting: Math (x 1.5); M1 or M2 (x 1.75);  
 Bio, Chem, Comb. Sci, DAT, ICT, Phy (x 1.5); LS (x 0.5)*

- BCSE was one of the **15 CUHK programmes** that admitted top students with **a score of 33 or above** in their best five HKDSE subjects in 2023 entry.



# Admission Requirements (for Non-JUPAS & International Applicants)

- Applicants seeking admission on the strength of qualifications other than HKDSE examination results (e.g., IB, GCE-AL, overseas qualifications) can apply through Non-JUPAS channels
- Will be considered on the basis of their education background and academic achievements
- Can apply for “Admission with Advanced Standing” (for particular qualifications only)

Check out details on the website of CUHK's Office of Admissions and Financial Aid:

Non-JUPAS Applications: <http://admission.cuhk.edu.hk/non-jupas-yr-1/requirements.html>

International Applications: <http://admission.cuhk.edu.hk/international/requirements.html>

# Admission Arrangements and Requirements (Senior Year Entry)



# Admission Arrangements (Senior Year Entry)

- To meet the minimum entrance requirements for **direct entry to year 3 of CENG / CSCI**, you need to have:
  - » successfully completed a **LOCAL** course of study leading to the qualification of **associate degree (AD) / higher diploma (HD)**  
AND
  - » Met the minimum required scores or grades in **English and Chinese languages** (e.g. HKDSE level 3 or above / IELTS 6.0 or above, etc.)
- To make your application more competitive, you need to demonstrate outstanding capabilities in **mathematics, programming and English**



# Admission Arrangements (Senior Year Entry)

- If you are unsuccessful for Senior Year Entry, you will be considered for **First Year Entry with Advanced Standing to the Computer Science and Engineering (BCSE)** programme. If admitted:
  - You will be exempted from up to 23 units. Most would be able to finish their studies in 3 years.
  - You will study a common 1st year and be allocated to either CENG or CSCI according to your CGPA after you finish your 1st year.
- For reference, students admitted to senior year in the past had a **CGPA of 3.5 or above**

Check out more details on *Senior Year Applications*:

<http://admission.cuhk.edu.hk/non-jupas-senior/requirements.html>

# Curriculum Structure



# Curriculum – Overview

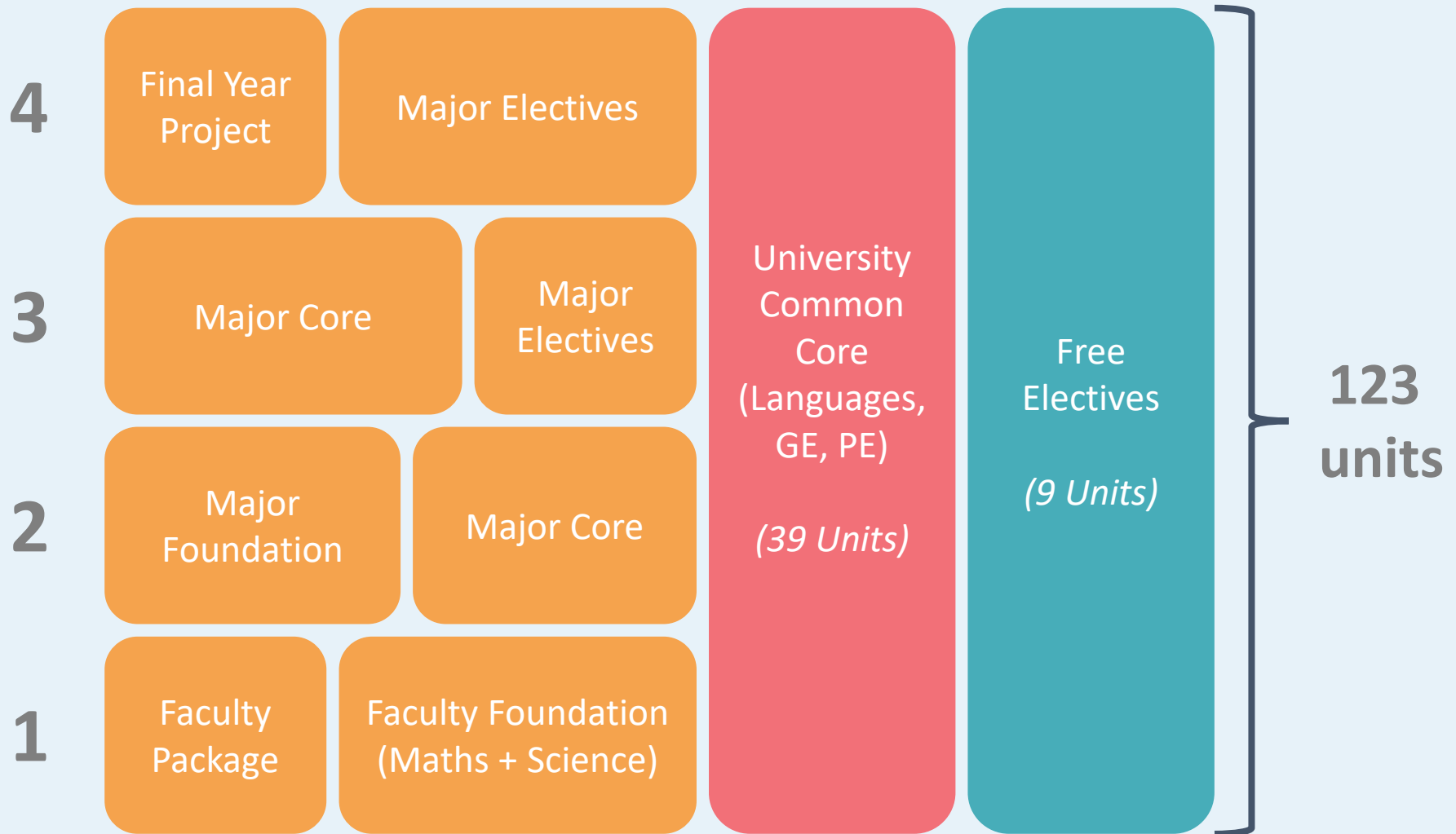

# University Core Requirements

University Core Courses	Units Requirements
English Language	8
Chinese Language	5
University General Foundation	6
University General Education	7 (At least 2 units in Area A, C, D)
College General Education	6
Understanding China (UGCP1001) <i>(online course - complete before graduation in any one term, including summer term)</i>	1
Hong Kong in the Wider Constitutional Order (UGCP1002) <i>(online course - complete before graduation in any one term, including summer term)</i>	1
Digital Literacy and Computational Thinking (ENGG1003 or ENGG1004)	3
Physical Education	2
<b>Total of units required</b>	<b>39</b>

# Curriculum – Major Requirements

4

Final Year  
Project

Major Electives

3

Major Core

Major  
Electives

2

Major  
Foundation

Major Core

1

Faculty  
Package

Faculty Foundation  
(Maths + Science)

75 units



# Major Requirements

Major Requirements	Computer Engineering	Computer Science
Faculty Package	9	
Foundation Courses	17	16
Major Required Courses	31	27
Research Components	6	
Stream Requirements	12	17
<b>Total of units required</b>	<b>75</b>	

# Curriculum – Faculty Package and Foundation

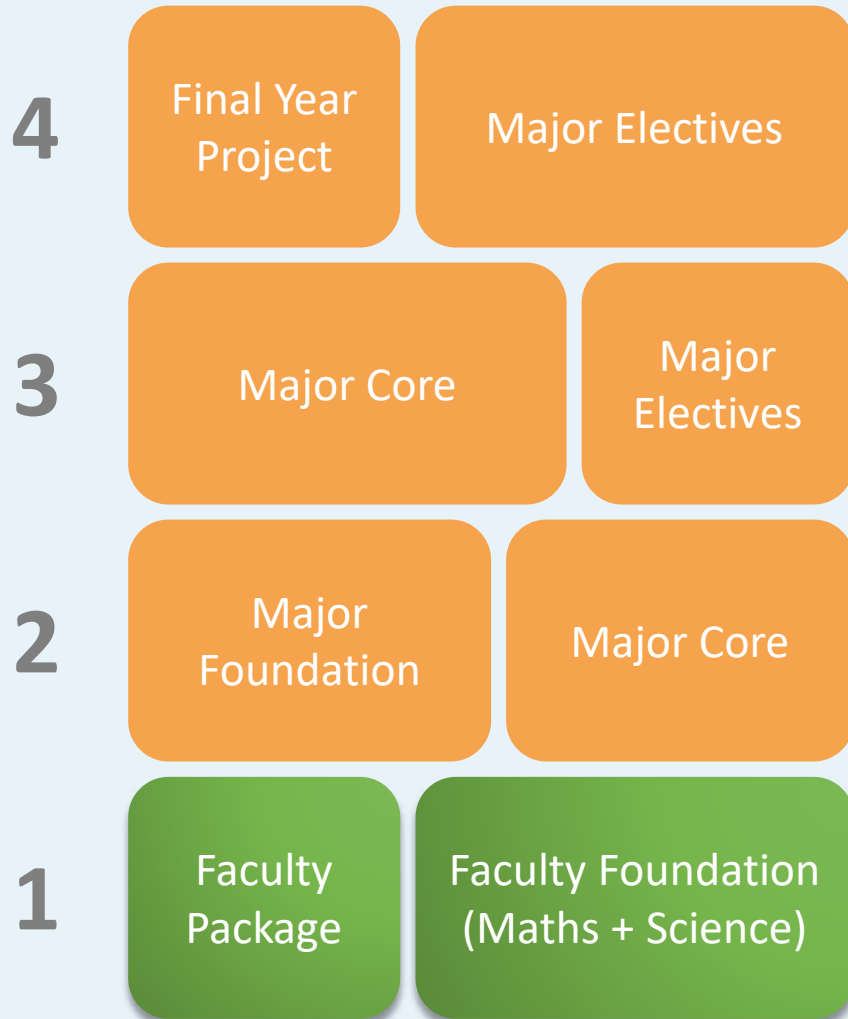

## Faculty Package and Foundation (15 units)

- » Problem Solving By Programming (ENGG1110)
- » Linear Algebra for Engineers (ENGG1120)
- » Multivariable Calculus for Engineers (ENGG1130)
- » Calculus for Engineers (MATH1510)
- » Foundation Science

# Curriculum – Major Foundation *(for CENG)*

4

Final Year  
Project

Major Electives

3

Major Core

Major  
Electives

2

Major  
Foundation

Major Core

1

Faculty  
Package

Faculty Foundation  
(Maths + Science)

## Major Foundation (11 units)

- » Introduction to Computing Using C++ (CSCI1120)
- » Complex Variables for Engineers (ENGG2720)
- » Differential Equations for Engineers (ENGG2740)
- » Probability for Engineers (ENGG2760)
- » Statistics for Engineers (ENGG2780)

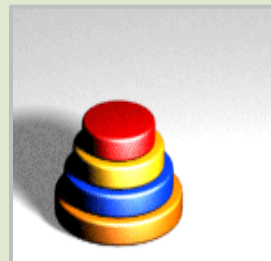

ROLL		PROBABILITY
2		1/36
3		2/36
4		3/36
5		4/36
6		5/36
7		6/36
8		5/36
9		4/36
10		3/36
11		2/36
12		1/36

# Curriculum – Major Core (*for CENG*)

4

Final Year  
Project

Major Electives

3

Major Core

Major  
Electives

2

Major  
Foundation

Major Core

1

Faculty  
Package

Faculty Foundation  
(Maths + Science)

## Major Core (31 units)

- » Digital Logic Design Laboratory (CENG2010)
- » Fundamentals of Embedded Systems (CENG2030)
- » Embedded System Design (CENG2400)
- » Computer Organization and Design (CENG3420)



# Curriculum – Major Core *(for CENG)*

4

Final Year  
Project

Major Electives

3

Major Core

Major  
Electives

2

Major  
Foundation

Major Core

1

Faculty  
Package

Faculty Foundation  
(Maths + Science)

## Major Core (31 units)

- » Data Structures (CSCI2100)
- » Software Engineering (CSCI3100)
- » Introduction to Operating Systems (CSCI3150)
- » Introduction to Discrete Mathematics and Algorithms (CSCI3190)
- » Computers and Society (CSCI3250)
- » Engineering Practicum (CSCI3251)

# Curriculum – Major Core (for CENG)

4

Final Year  
Project

Major Electives

3

Major Core

Major  
Electives

2

Major  
Foundation

Major Core

1

Faculty  
Package

Faculty Foundation  
(Maths + Science)

## Major Core (31 units)

- » Fundamental of Electric Circuits (ELEG2202)
- » Digital Logic and Systems (ENGG2020)

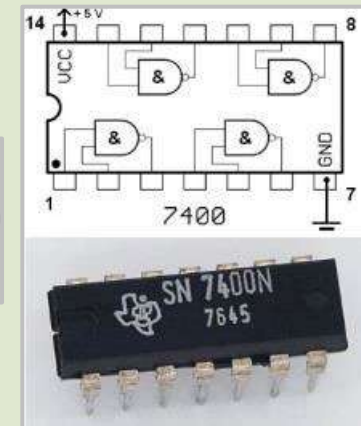
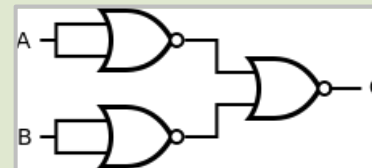

# Curriculum – Major Electives *(for CENG)*

4

Final Year  
Project

Major Electives

3

Major Core

Major  
Electives

2

Major  
Foundation

Major Core

1

Faculty  
Package

Faculty Foundation  
(Maths + Science)

## Major Electives (12 units) Streams

1. Embedded Systems
2. VLSI Design and EDA

## Non-Stream

3. General Computer Engineering

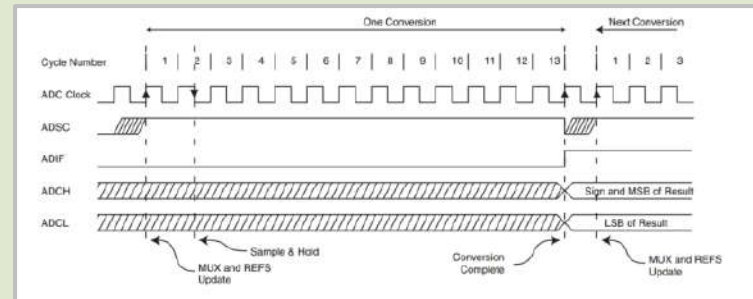

# Curriculum – Major Foundation *(for CSCI)*

4

Final Year  
Project

Major Electives

3

Major Core

Major  
Electives

2

Major  
Foundation

Major Core

1

Faculty  
Package

Faculty Foundation  
(Maths + Science)

## Major Foundation (10 units)

- » Introduction to Computing Using Java (CSCI1130)
- » Discrete Mathematics for Engineers (ENGG2440)
- » Probability for Engineers (ENGG2760)
- » Statistics for Engineers (ENGG2780)



ROLL		PROBABILITY
2		1/36
3		2/36
4		3/36
5		4/36
6		5/36
7		6/36
8		5/36
9		4/36
10		3/36
11		2/36
12		1/36



# Curriculum – Major Core (for CSCI)

4

Final Year  
Project

Major Electives

3

Major Core

Major  
Electives

2

Major  
Foundation

Major Core

1

Faculty  
Package

Faculty Foundation  
(Maths + Science)

## Major Core (27 units)

- » Computer Organization and Design (CENG3420)
- » Data Structures (CSCI2100)

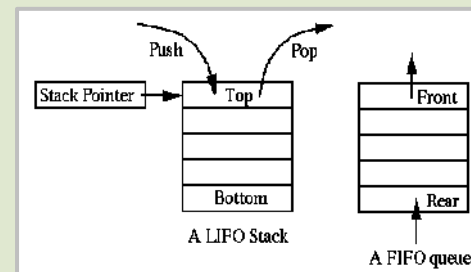
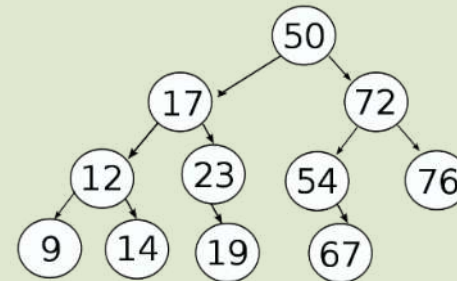

# Curriculum – Major Core *(for CSCI)*

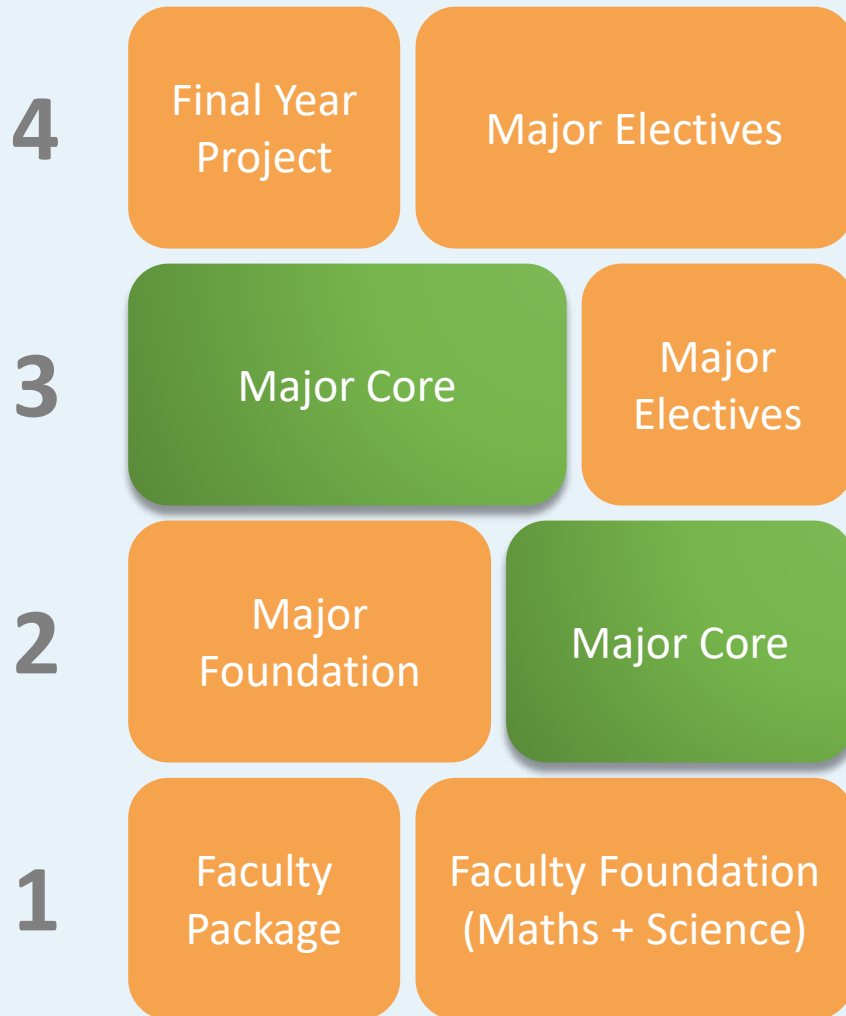

## Major Core (27 units)

- » Software Engineering (CSCI3100)
- » Formal Languages and Automata Theory (CSCI3130)
- » Introduction to Operating Systems (CSCI3150)
- » Design and Analysis of Algorithms (CSCI3160)
- » Principles of Programming Languages (CSCI3180)

# Curriculum – Major Core (for CSCI)

4

Final Year  
Project

Major Electives

3

Major Core

Major  
Electives

2

Major  
Foundation

Major Core

1

Faculty  
Package

Faculty Foundation  
(Maths + Science)

## Major Core (27 units)

- » Computers and Society (CSCI3250)
- » Engineering Practicum (CSCI3251)
- » Digital Logic and Systems (ENGG2020)

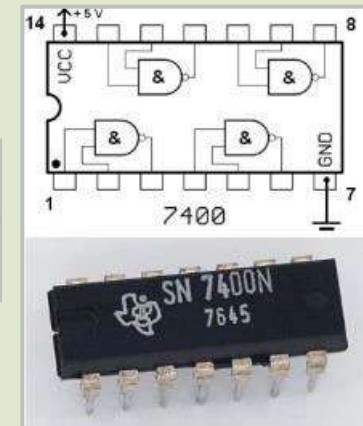
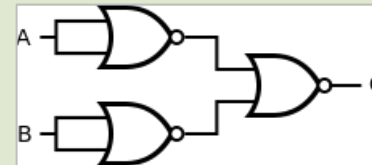

# Curriculum – Major Electives *(for CSCI)*

4

Final Year  
Project

Major Electives

3

Major Core

Major  
Electives

2

Major  
Foundation

Major Core

1

Faculty  
Package

Faculty Foundation  
(Maths + Science)

## Major Electives (17 units) Streams

1. Intelligence Science
2. Database and Information Systems
3. Rich Media
4. Distributed Systems, Networks and Security
5. Algorithms and Complexity
6. Data Analytics

## Non-Stream

7. General Computer Science

# Curriculum – Final Year Project (FYP)



## Final Year Project (6 units)

- » Pick an interesting topic
- » Interdisciplinary nature
- » Apply the knowledge learnt in the previous courses
- » Many open topics. Your creativity and discussion with the supervisor
- » Complete a project under the supervision of an advisor

**Open topic FYP** – you may also propose a project to a professor

# FYP (AI + Bioinformatics)

- Apply machine learning to predict RNA-protein interaction

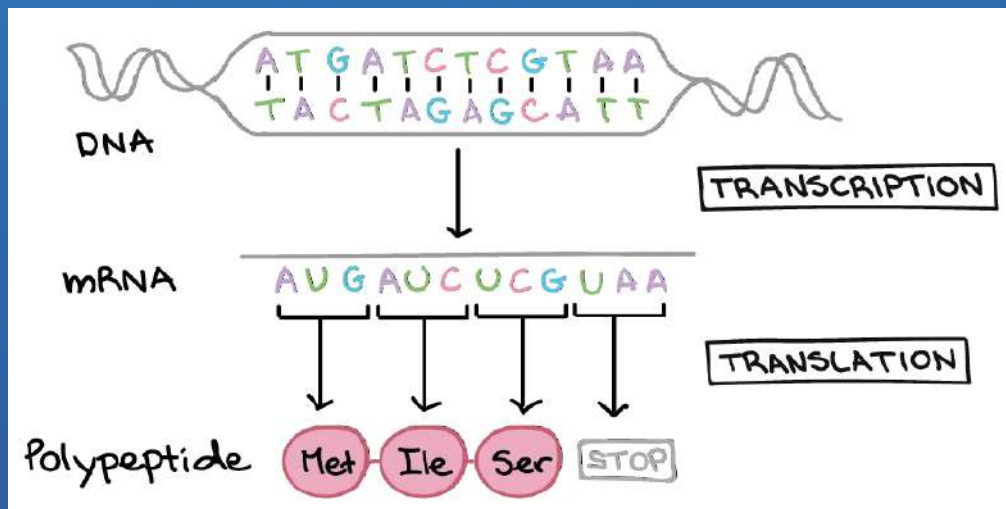

RNA-binding protein (RBP)

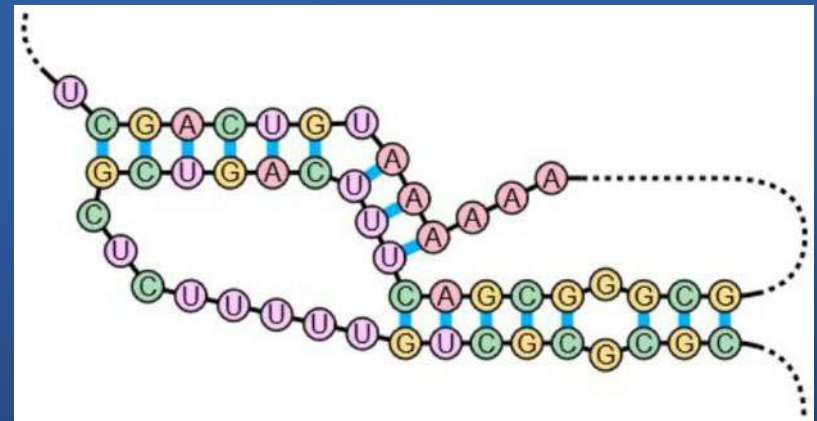
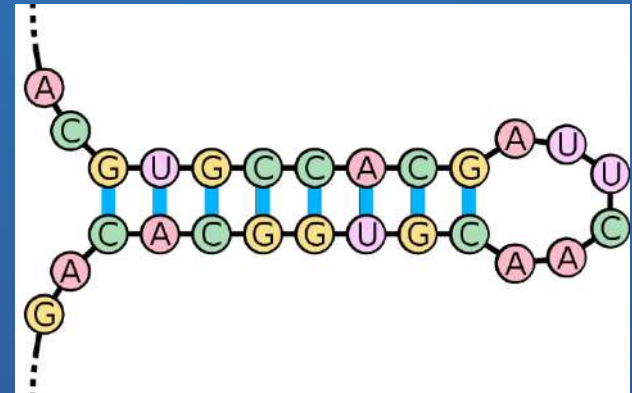

RNA folds to a specific structure to fit into the protein binding site

# FYP (AI + Multimedia)

- Design a neural network that learns to produce a tiling

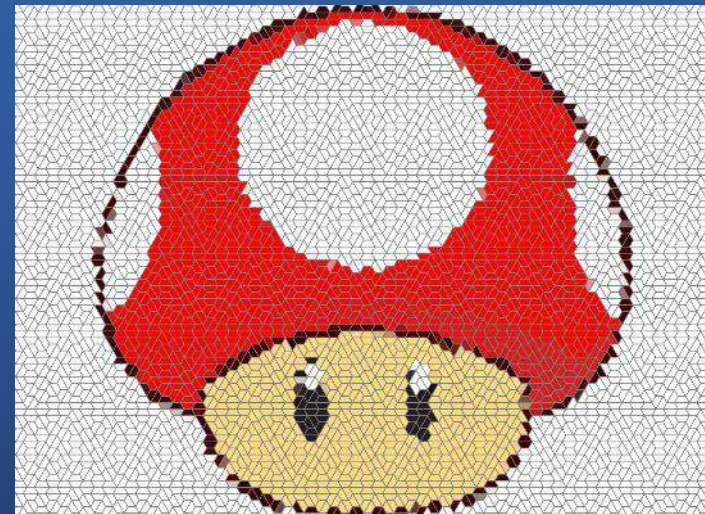
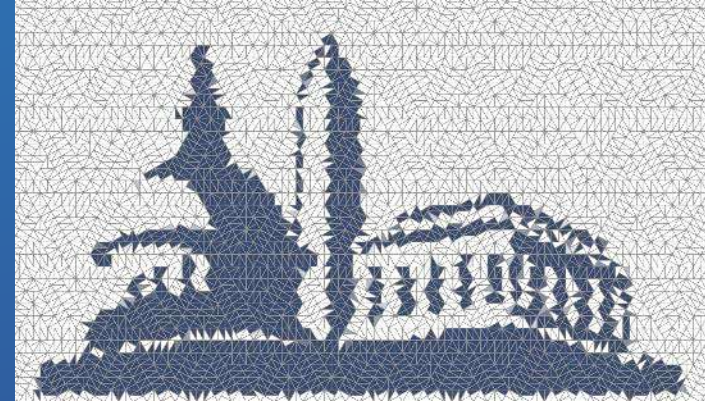
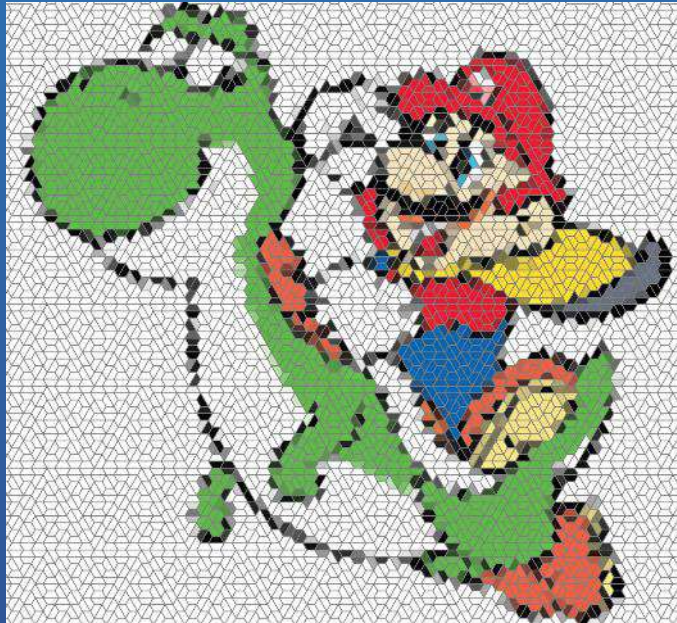
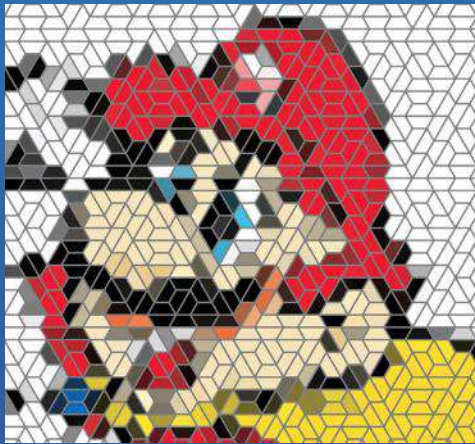

# FYP (AI + Computer Vision)

## • Chinese Medicinal Herb Recognizer

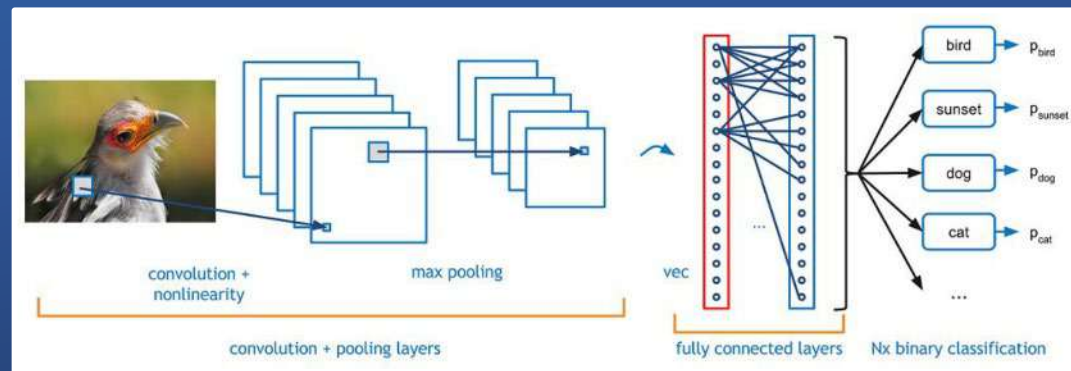
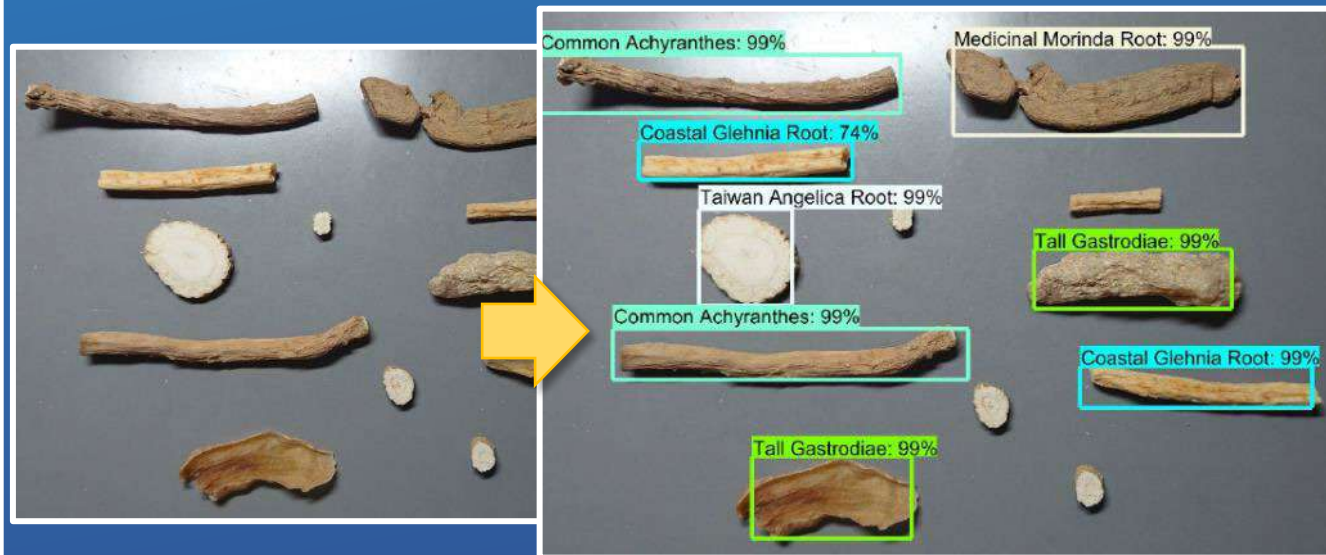
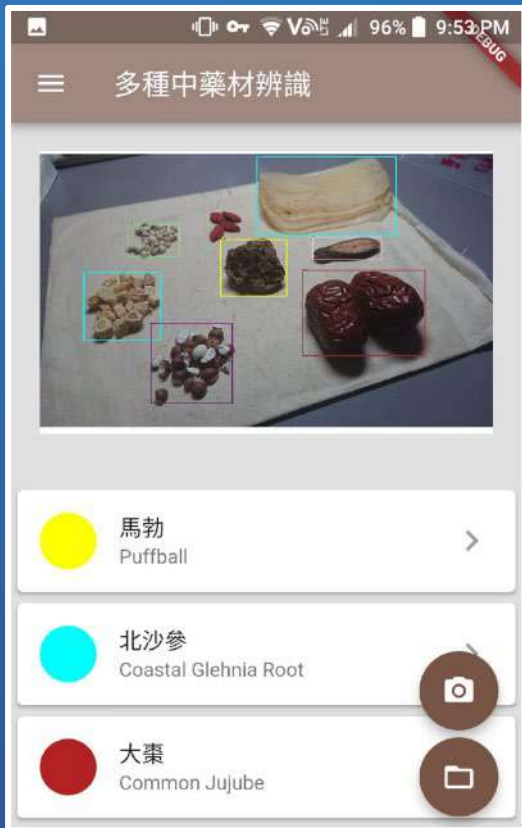



# FYP (Self-driving Robots)

- Controls: Serial, Bluetooth, and Raspberry Pi, *etc.*



Arduino Mega 2560



Raspberry Pi 3b+

From FYP MCY1801

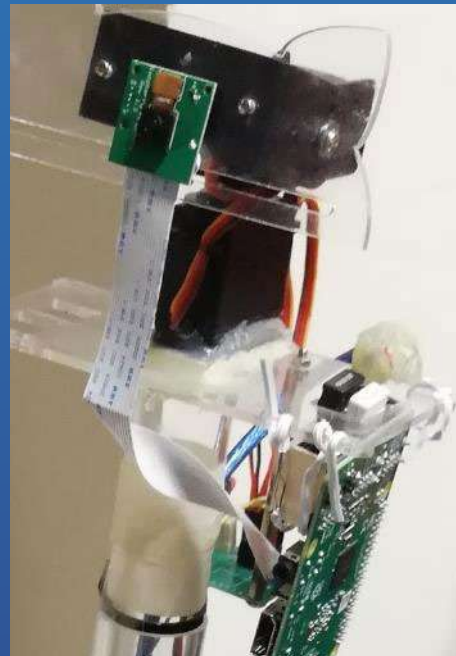

Camera module

PiCamera &  
Raspberry Pi &  
Servo Motors



Motor  
Drivers &  
Stepper  
Motors

Arduino Mega  
2560 & Power  
Supplies & Motor  
System

# FAQs



## FAQ Content:

Q: Will there be any interview?

Q: How does the major allocation work?

Q: Computer Engineering or Computer Science?

Q: How many students will be admitted?

Q: Will there be any exchange opportunity?

Q: Will there be any scholarship or financial aid?

Q: What are the career prospects of CENG/CSCI graduates?

Q: Can I transfer to AIST or other majors in Year 2?

Q: Can I declare AIST / CENG / CSCI as second major or minor?

Q: I am still struggling to choose between AIST / CENG / CSCI.

What can I do?



**Q: Will there be any  
interview?**



# Interview Arrangements (JUPAS)

- Interviews will be arranged in **mid/late June every year**.
- Not all applicants will be interviewed. We only consider **Band A applications** when shortlisting interviewees.
- Shortlisted applicants will receive an **invitation email by early June** for the details, *e.g., date, time, format, etc.*
- Stay tuned! **Check your email** regularly for the latest update!



# Interview Arrangements (Non-JUPAS)

- Interviews will be conducted **in batches from ~Jan. every year.**
- You are encouraged to **attach adequate supporting documents, e.g., transcripts, predicted grade, certificates, etc., in your application** for our holistic review.
- Shortlisted applicants will receive an invitation email for the details, *e.g., date, time, format, etc.*
- Stay tuned! **Check your email** regularly for the latest update!

**Q: How does the major allocation work?**



# Major Allocation

- BCSE students will be allocated into either CENG or CSCI **according to their CGPA** after finishing their 1<sup>st</sup> year of study
- Students with **outstanding entry grades / renewable scholarships** and **good academic performance in their first year of study** are guaranteed their first choice of major
- It is expected that a relatively high percentage of students would be allocated to their preferred major.

More details:

<https://www.cse.cuhk.edu.hk/admission/cengn/major-allocation-cengn/>

<https://www.cse.cuhk.edu.hk/admission/cscin/major-allocation-cscin/>



**Q: Computer Engineering (CENG)  
or Computer Science (CSCI) ?**



# Differences between CENG and CSCI

- **Computer Engineering** is more about **building things**
  - » To take care of design and hardware/software integration (*e.g.*, lower cost, higher speed, more energy efficient)
- **Computer Science** is more about **designing software solutions**
  - » To take care of coding, software architecture, and the underlying theory



**Q: How many students  
will be admitted to  
BCSE / CENG / CSCI?**



# Local Intake Quota

- First Year Entry to Computer Science and Engineering (BCSE) (JS4412):  
**107**
- Senior Year Entry to Computer Engineering (CENG) / Computer Science (CSCI):  
**11**



*Note: There is no fixed quota for international students and Mainland students attempting Gao Kao.*

**Q: Will there be any  
exchange opportunity?**



# Exchange to Overseas Universities

- You are encouraged to join the exchange programme to **broaden your horizon** and **learn with peers from diverse background**
- List of some overseas universities for the exchange
  - » Macquarie University, Australia
  - » University of Toronto, Canada
  - » Shanghai Jiao Tong University, China
  - » Telecom & Management SudParis, France
  - » Royal Institute of Technology (KTH), Sweden
  - » University of California, Davis, USA
  - ...



Submit you application via [Office of Academic Links \(OAL\)](#)!

**Q: Will there be any scholarship or financial aid?**



# Scholarships and Financial Aids

- The Government and the University offer various **scholarships** and **financial aids** depending on student's financial situation, or their outstanding performance in academic or other areas
- List of some scholarships and financial aids
  - » Admission Scholarships
  - » Scholarships for Overseas Studies
  - » Government or University Financial Aid
  - » Summer Subsistence and Travel Loan Scheme
  - » Student Residence Bursary Scheme
  - ...



Check out more details on the website of CUHK's Office of Admissions and Financial Aid: <https://admission.cuhk.edu.hk/finance.html>



**Q: What are the  
career prospects of  
CENG/CSCI graduates?**



# Career Prospects

- Employers of our graduates include:
  - » Google
  - » Intel
  - » Microsoft
  - » IBM
  - » Apple
  - » Facebook
  - » Yahoo
  - » Deloitte
  - » Hong Kong Government
  - » Investment Banking Institutes
  - ... ..



# Career Choices

- ✓ Entrepreneur
- ✓ Systems programmer
- ✓ Mobile app developer
- ✓ Database administrator
- ✓ Management/IT consultant
- ✓ Researcher
- ✓ Bioinformatics specialist
- ✓ System consultant
- ✓ Data analyst
- ✓ Web and content developer
- ✓ Network administrator
- ✓ Game designer/programmer
- ✓ Medical imaging specialist
- ✓ Software engineer
- ✓ System analyst
- ✓ Systems administrator
- ✓ Network engineer
- ✓ Data miner
- ✓ Systems integrator
- ✓ Business analyst



**Q: Can I transfer to AIST or other majors in Year 2?**



# If you look for AIST / other majors instead...

- You may submit application for **change of major** (to AIST or other majors), subject to prevailing regulations stipulated by RES and approval by relevant unit(s).
- If you are determined to go for AIST, you may choose **JS4468 / AISTN** as your first choice directly.



**Q: Can I declare  
AIST / CENG / CSCI as  
second major or minor?**



# Declare Second Major / Minor

- You are **not allowed to declare AIST / CENG / CSCI as your second major or minor** if you are a CSE student.
- However, you are encouraged to broaden your horizons and declare second major / minor offered by other departments.



**Q: I am still struggling to  
choose between  
AIST / CENG / CSCI.  
What can I do?**





# If you are still struggling to choose...

- You can **go through our website and admission materials** for a better understanding before applying, and **write to us via email at [ug-admiss@cse.cuhk.edu.hk](mailto:ug-admiss@cse.cuhk.edu.hk)** if you have any further queries.
- You can **join our outreach activities** in the future and chat with our teachers and student ambassadors.



# Contact Us



(852) 3943 4269



[ug-admiss@cse.cuhk.edu.hk](mailto:ug-admiss@cse.cuhk.edu.hk)



[www.cse.cuhk.edu.hk](http://www.cse.cuhk.edu.hk)



**See you in Fall 2024 !**

