



HKIX Updates at HKNOG 11.0

HKNOG 11.0

Kenneth Chan

HKIX

14 October 2022



HKIX Today

- Supports both MLPA (Multilateral Peering) and BLPA (Bilateral Peering) over layer 2
- Supports IPv4/IPv6 dual-stack
- More and more non-HK participants
- ~340 different networks (autonomous systems) connected
- 560+ physical connections in total
 - 117 **100GE**, 320+ **10GE** & 120+ **GE**
- 2.29+Tbps (5-min) total traffic at peak
- Annual Traffic Growth **10-30%**

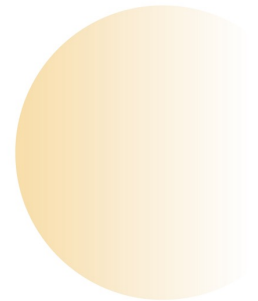



100GE Connections at HKIX

Total HKIX 100G Ports Connected (2019 OCT - 2022 SEP)

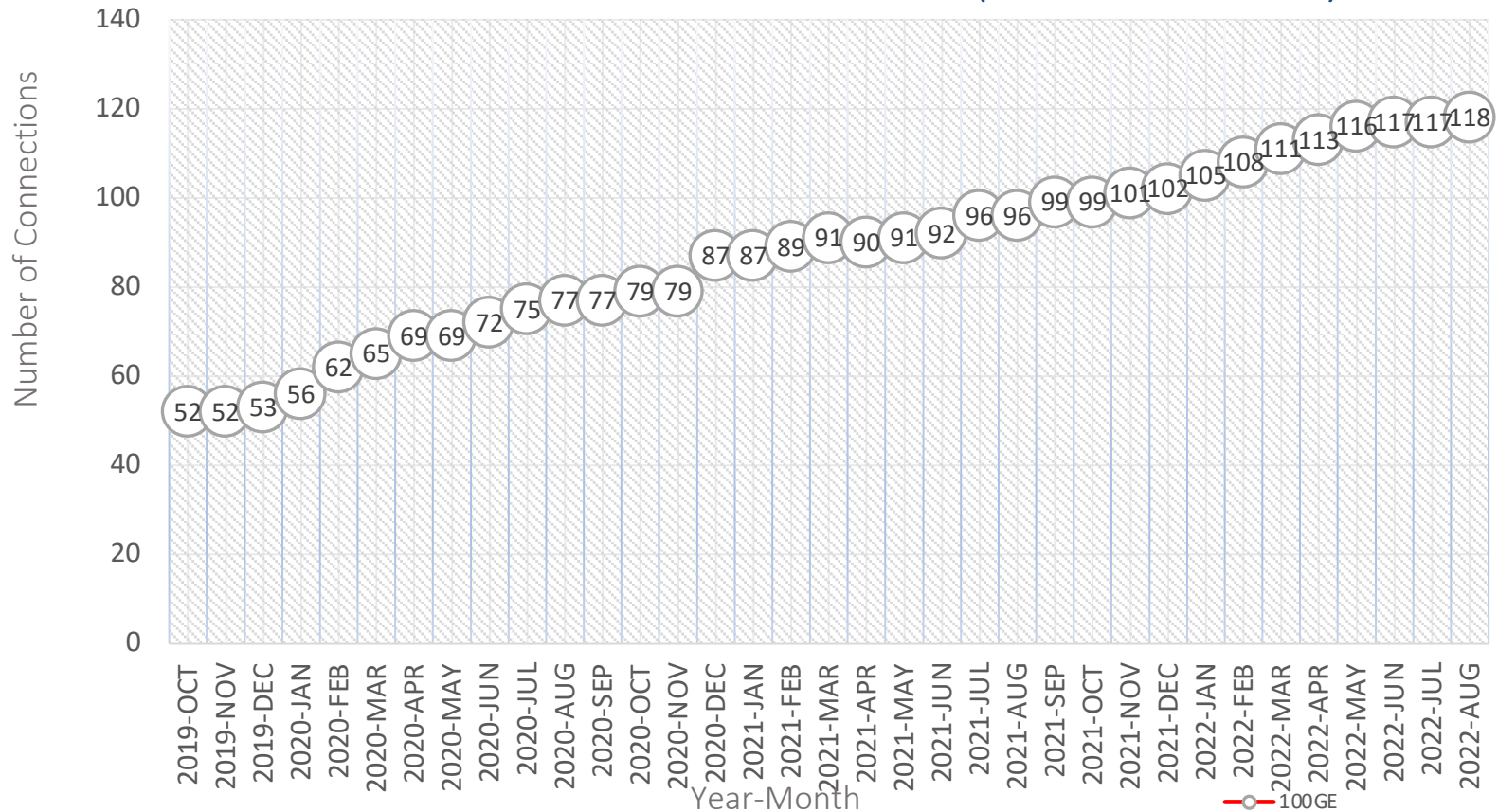



HKIX's 100GE participants at a glance (1)

Content Provider

Tencent 腾讯

NETFLIX

facebook

Akamai

Google

amazon

YAHOO!

Microsoft

TVB

ByteDance

BGP.NET
BGP Network (M) Sdn Bhd

BIGO

zscaler

i3D.NET
PERFORMANCE HOSTING

G-CORE LABS

SKYCABLE

Limelight

TCLLOUDNET

ISP Regional

TELSTRA

中国移动
China Mobile International

AWN

PCCW Global

Telin
by Telkom Indonesia

China
unicom 中国联通

HURRICANE ELECTRIC
INTERNET SERVICES

RETN®

CONVERGE

SK broadband

DITO
TELECOMMUNITY

FPT

VOCOM

Globe



HKIX's 100GE participants at a glance (2)

<u>ISP Local</u>	<u>Retail & Gaming</u>	<u>Anti-DDoS Provider</u>	<u>Data Centre</u>	<u>Others</u>



Network Evolution @HKIX

1995

HKIX established the first HK Internet Exchange in CUHK

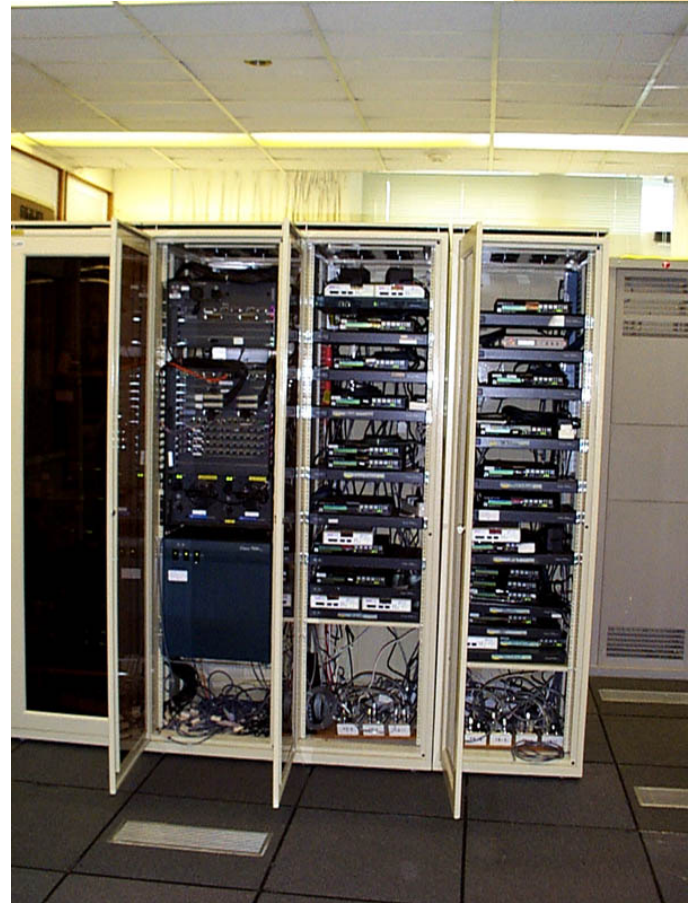

2001

- The first 6513 switch to support 1Gbps and 10Gbps connections in Hong Kong

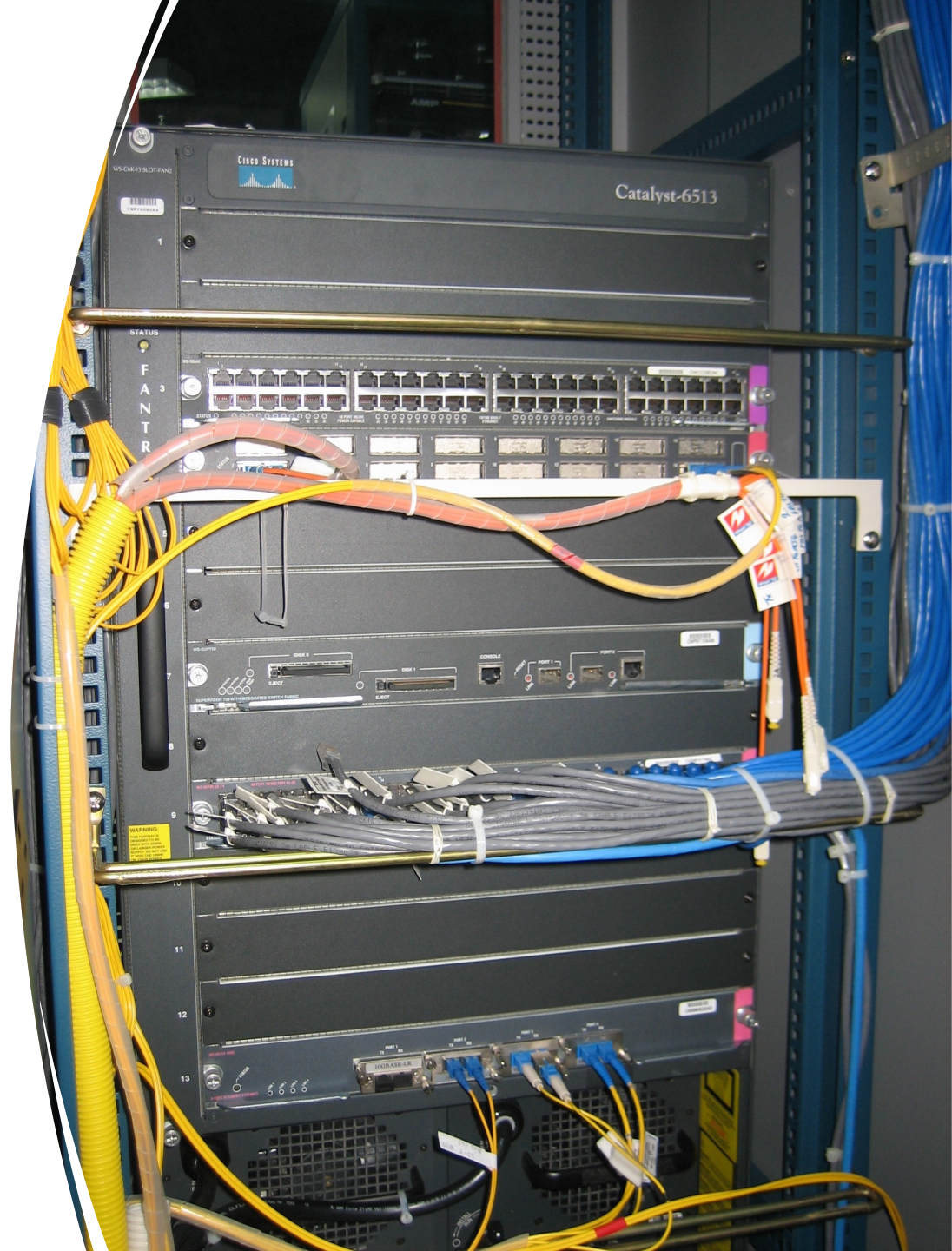

2009

Deployed the first 7018 switch to support high density 10Gbps connections





2014

HKIX deployed dual Core Sites at CUHK and implemented Nexus 7710 switch and supported the first 100Gbps connection in Hong Kong

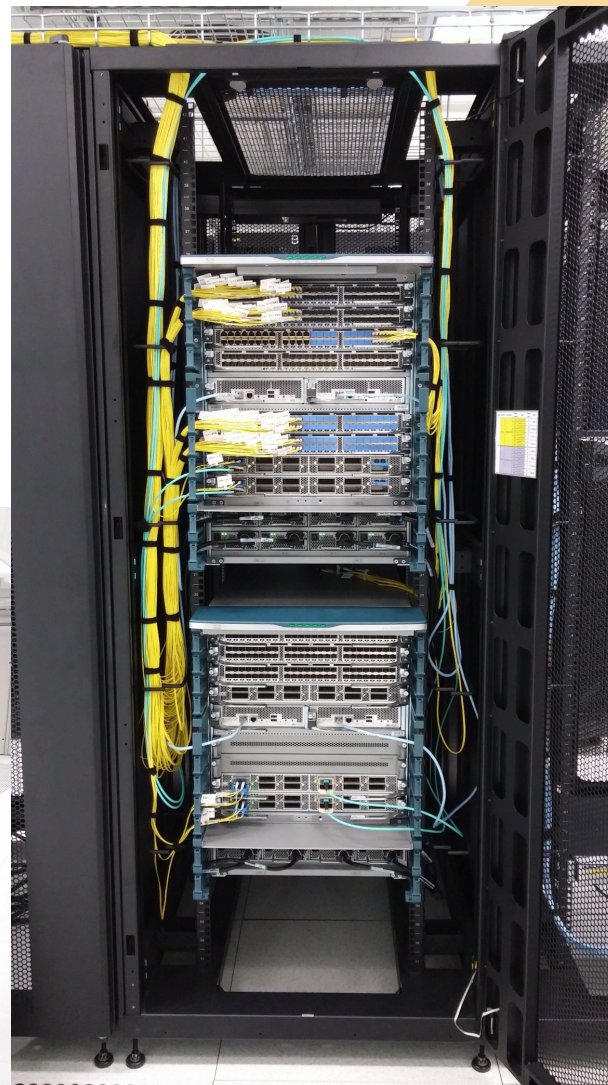

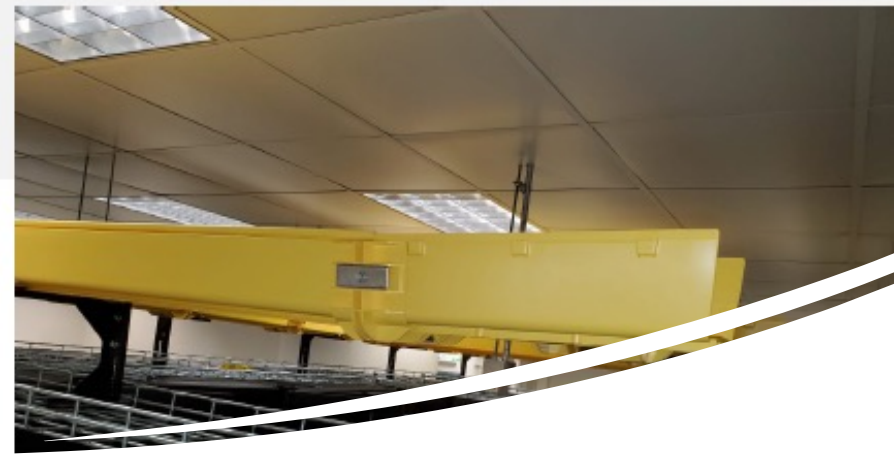

2021

HKIX deployed a new Core Site at Cyberport and implemented VXLAN EVPN technology and supported 1/10Gbps, 100Gbps and 400Gbps connections



HKIX New Core Site

- The new core site **HKIX1c** is located on Hong Kong Island with independent power grid of core sites of **HKIX1** and **HKIX1b**
- All core sites contain Core Switches and Access Switches interconnected by multiple 100GE/400GE links
- All core sites are running in Active-Active mode
- All sites together provide power resilience, chassis resilience as well as site resilience
- The architecture is highly scalable and can support more satellite sites and resellers outside of CUHK campus



HKIX VXLAN EVPN Deployment

- Multi-mode fibers
- Single-mode fibers

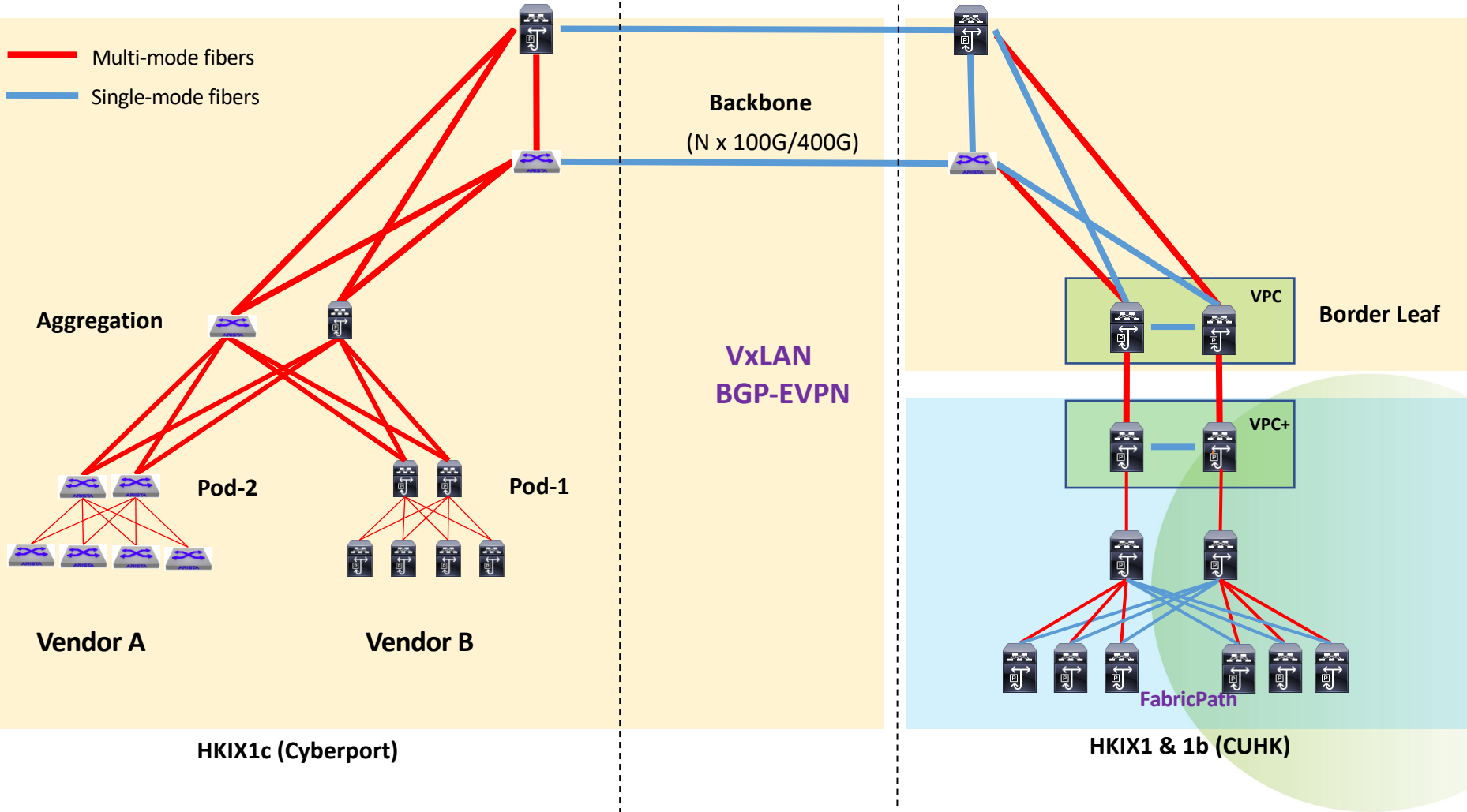



HKIX VXLAN EVPN Deployment

- Network Design Consideration:
 - Underlay routing protocol:
 - BGP vs IGP (OSPF/ISIS)
 - Link/Loopback/Management IP assignment
 - Interoperability between vendors

HKIX New Architecture (2021 and Beyond)

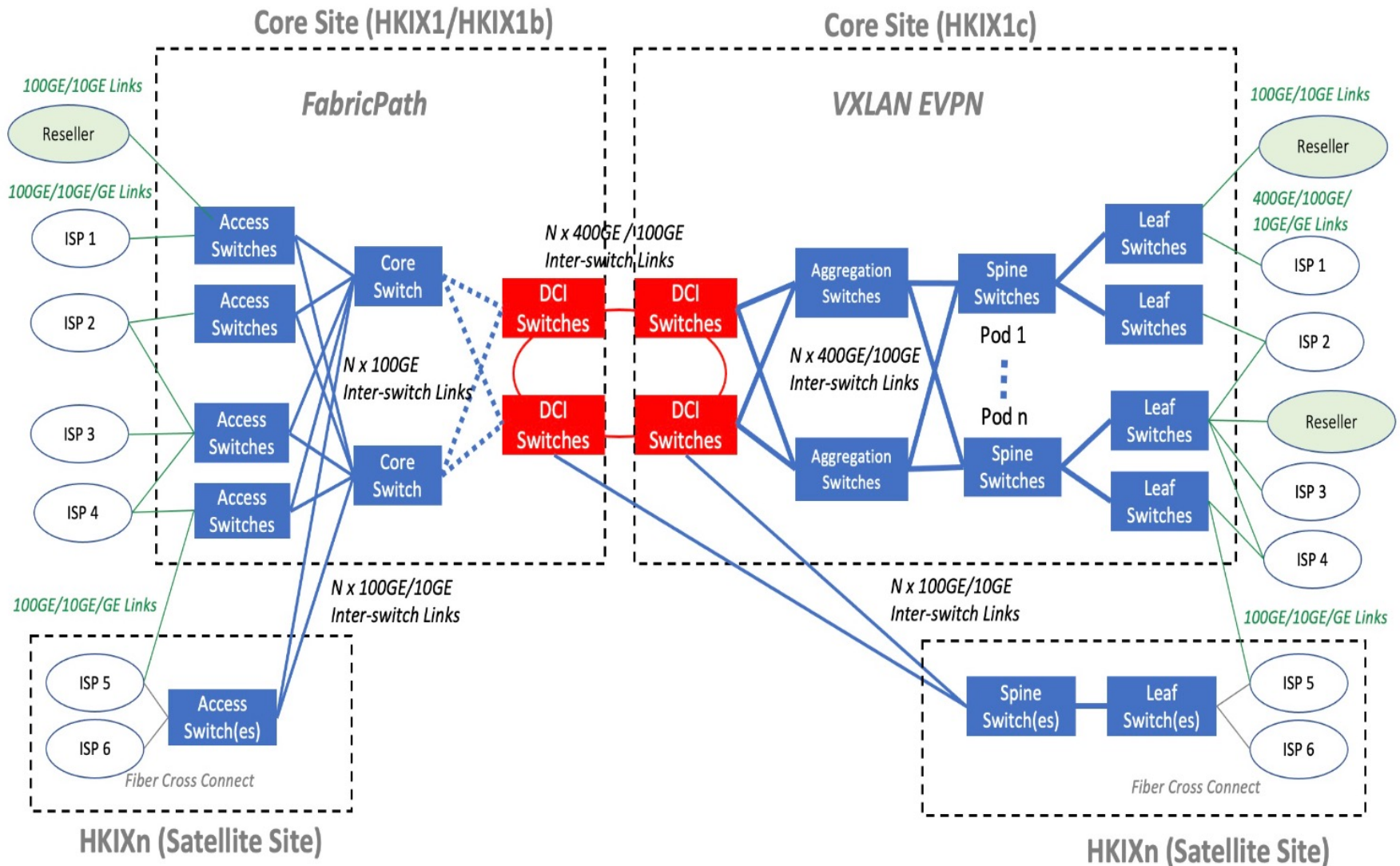

HKIX Reseller Setup – Shared Ports

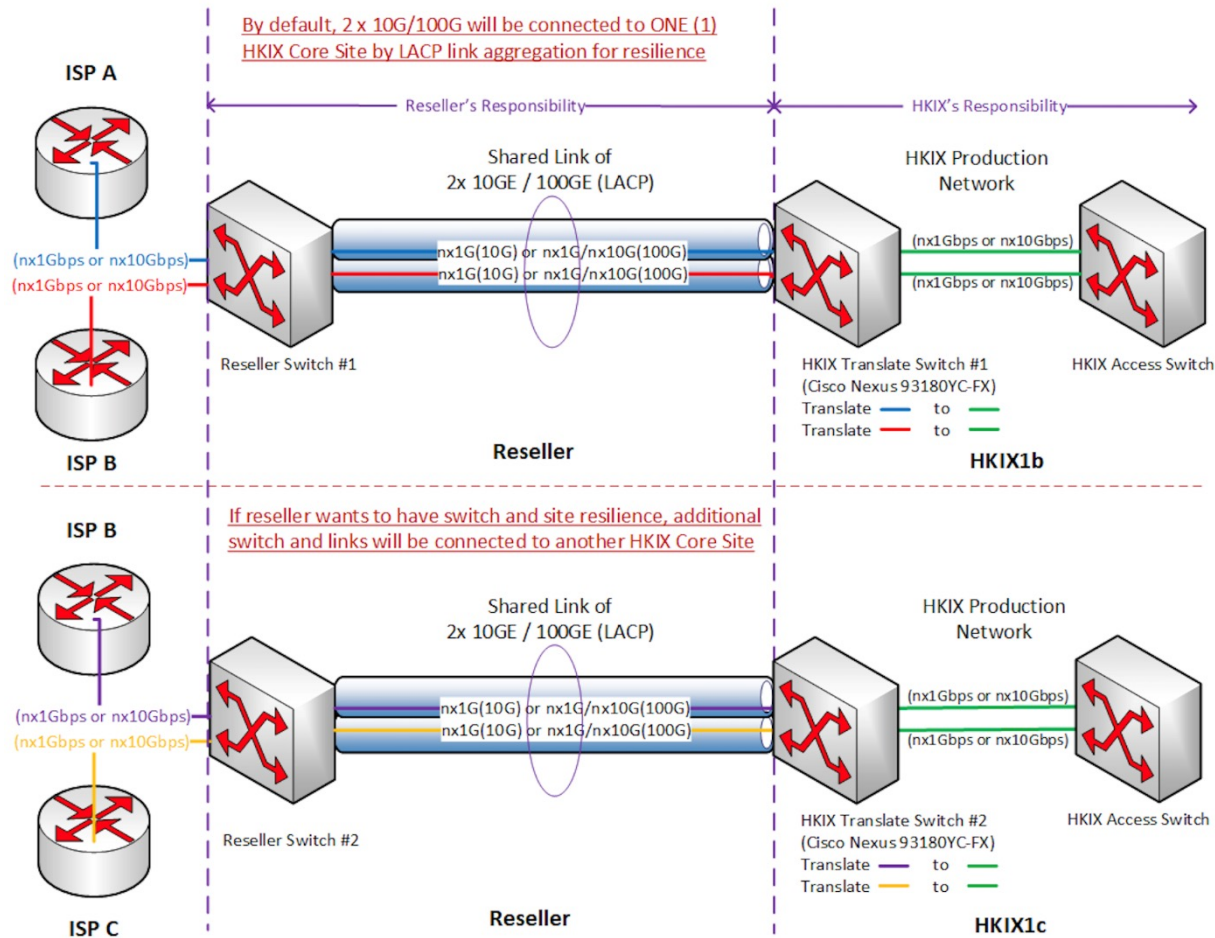

HKIX Reseller Setup – Dedicated Ports

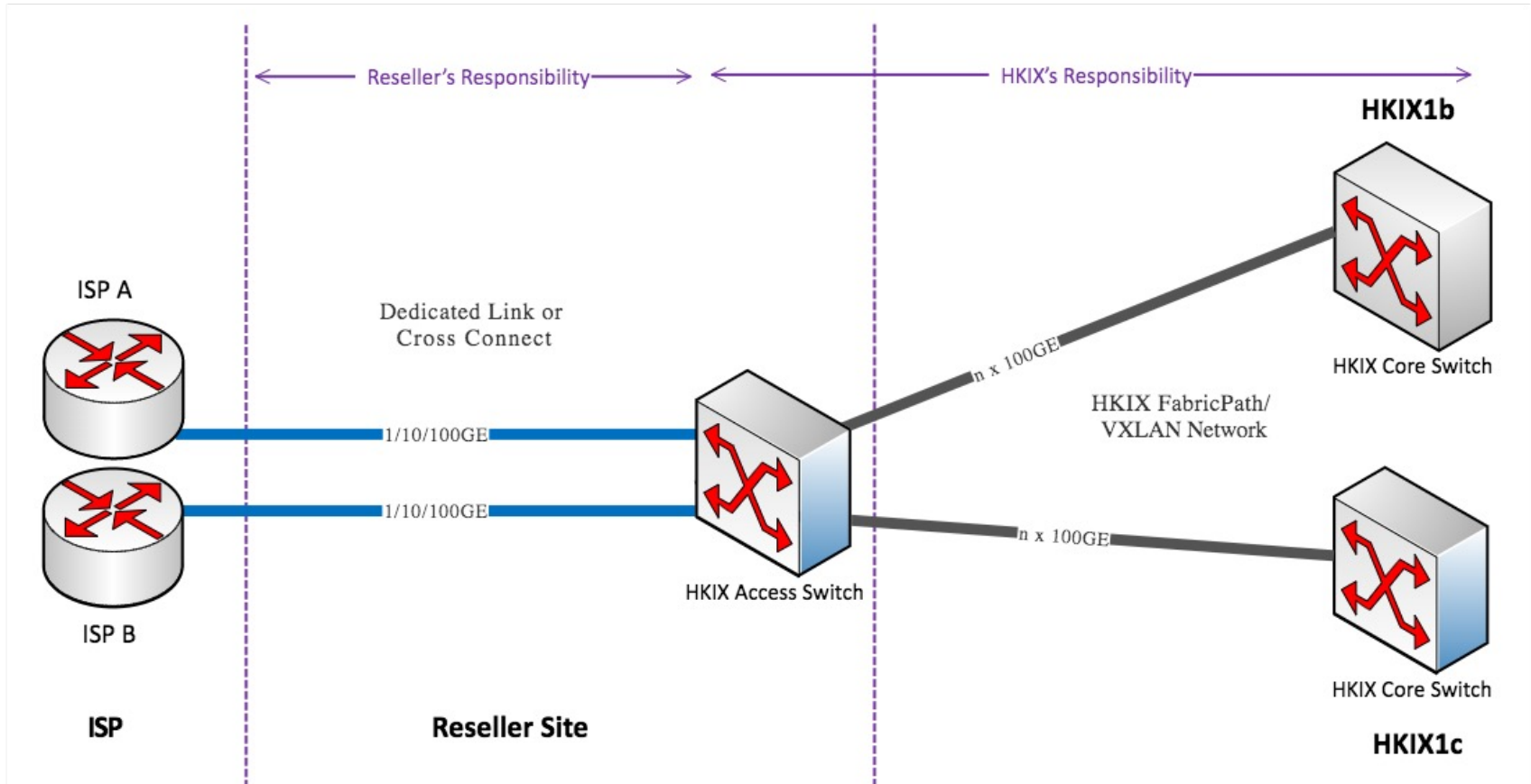



Reseller vs Satellite Site vs Core Site

	VLAN	x-Connect	Local Loop	Sign Contract with
Reseller (Shared Ports)	Y			Reseller
Reseller (Dedicated Ports)		Y		Reseller
Satellite Site Ports		Y		HKIX
Core Site Ports			Y	HKIX

*Local loop / x-Connect / special connection charges will be charged by relevant service providers

Inter-connections for HKIX Satellite Sites and Resellers

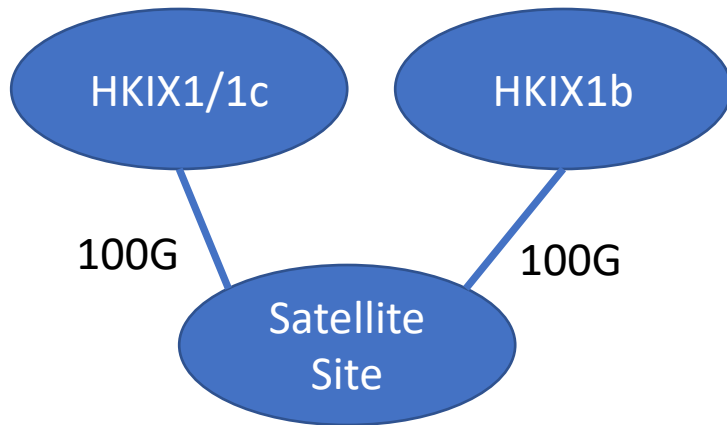

Minimum Links: 2 x 100G

**Satellite Site / Reseller
(Dedicated Ports)**

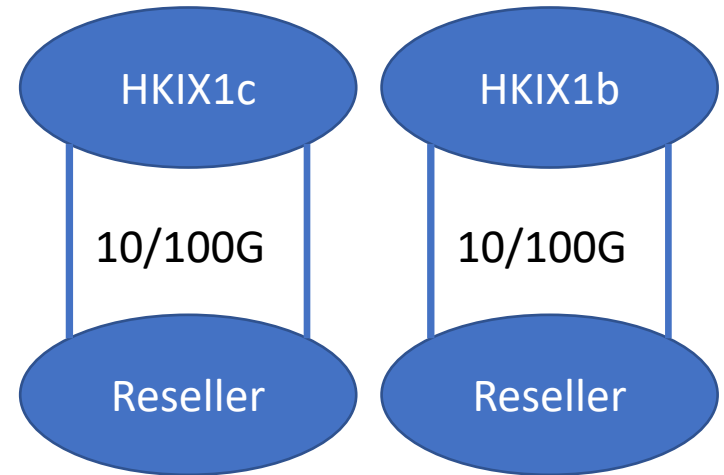

Minimum Links: 2 x 10G/100G

**Reseller
(Shared Ports)**



Decommission of HKIX1 in 2024

- **HKIX1b** and **HKIX1c** will be the two core sites of HKIX which provide full resilience of core and access switches and route servers for participants to connect
- The old switches at HKIX1 will be decommissioned and all connections at HKIX1 need to be migrated to HKIX1c
- No new port assignment to HKIX1 now
- HKIX will decommission the old switches and all connections at HKIX1 by [30 Jun 2024](#)



What you need to do for your connections at HKIX1

- You are encouraged to start the migration as soon as possible to enjoy the full benefits of new switches earlier and to avoid last-minute rush
- HKIX will assist and assign new port at HKIX1c for the migration
- HKIX will NOT be responsible for any relocation or upgrade charges associated with your local loop providers or any other parties
- Please contact your FTNS providers for the local loop relocation arrangement



HKIX1c Migration Schedule

Support and Services	Schedule
Production of HKIX1c	Completed (Aug 2021)
Support GE and 10GE Participants	Completed (Aug 2021)
Route Servers (IPv4 & IPv6) Migration	Completed (Oct 2021)
Support 100GE Participants	Completed (Jan 2022)
Support 400GE Participants	Completed (Oct 2022)
HKIX1 Connections Migration	In Progress (Oct 2022 – Jun 2024)
End-of-support and Decommission of HKIX1	30 Jun 2024



HKIX Network Security Updates

- Port Security Enforcement on HKIX ports
- Support Remote Triggered Black Hole Filtering (RTBH) for anti-DDoS
 - 86 participants joined
- Support Resource Public Key Infrastructure (RPKI) for route server prefix
- HKIX as a member of Mutually Agreed Norms for Routing Security (MANRS)
 - Promote MANRS to the HKIX participants
 - 27 connected participants have implemented the MANRS

RPKI Deployment at HKIX

- Fully Implemented on HKIX route servers started in Jun 2020
- Check BGP routes with RPKI validators and drop invalids
- Accept and tag valid and unknown routes with 4635:65021 and 4635:65022 respectively
- Blackhole /32 route will be accepted

	2020		2021		2022	
RPKI Validation	No. of Routes	%	No. of Routes	%	No. of Routes	%
RPKI Valid	100,497	25.7%	162,860	37.3%	286,487	47.5%
RPKI Not Found	289,070	73.9%	271,506	62.2%	313,578	52%
RPKI Invalid (Dropped)	1,776	0.45%	2,031	0.47%	2,930	0.5%
Total Routes Received	391,343	100%	436,397	100%	602,995	100%

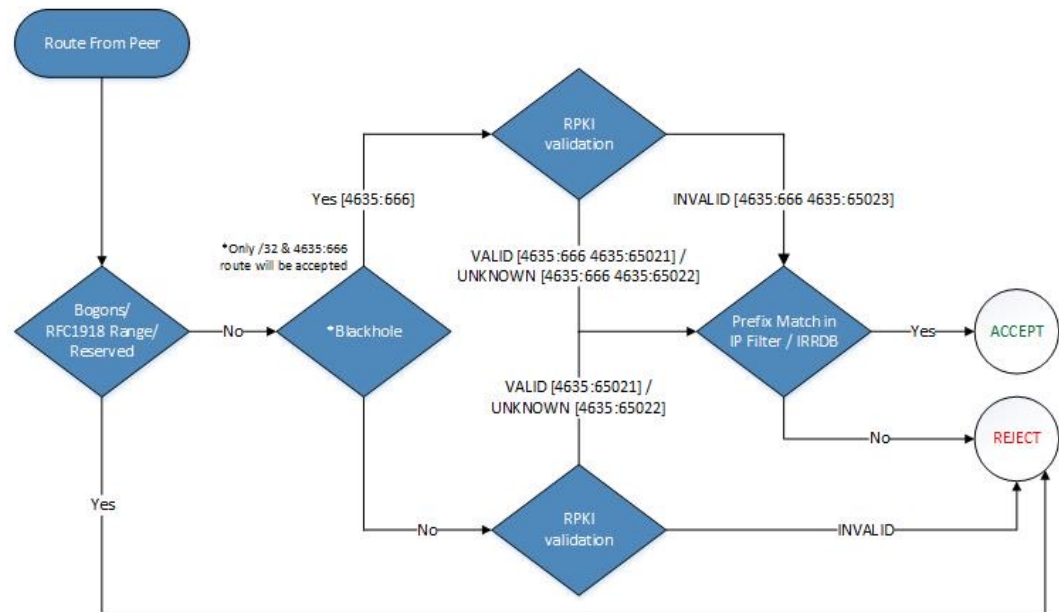



HKIX Completed / Planned Projects 2022-23

400GE support
at HKIX Core Sites

DWDM and dark
fibers between
HKIX Core Sites

Support 4-Byte AS
BGP Community
on Route Servers

HKIX1 migration to
HKIX1b/HKIX1c

Enhanced portal
services for
participants

NTP servers for
HKIX participants



400GE Technical Spec at HKIX Core Sites

Optics	Standard	Maximum Reach
QDD-400G-FR4	400GBASE-FR4	2km
QDD-400G-LR4	400GBASE-LR4	10km

400GBASE-FR4

- QSFP-DD
- Up to 2km transmission on single mode fiber (SMF)
- Data Rate 106.25Gbps (PAM4) per channel.
- Maximum power consumption 12W
- Duplex LC connector

400GBASE-LR4

- QSFP-DD
- Up to 10km transmission on single mode fiber (SMF)
- Data Rate 106.25Gbps (PAM4) per channel.
- Maximum power consumption 12W
- Duplex LC connector



IX name	Hong Kong Internet eXchange (HKIX)
City, Country	Hong Kong
Point of Presence	Core Sites: HKIX1 & HKIX1b @CUHK / HKIX1c @Cyberport HKIX-R&E: HKIX-R&E@MEGA-i Satellite Sites: HKIX2 @CITIC, HKIX3/HKIX3b @iAdvantage, HKIX4 @NTT, HKIX5 @KDDI
# of connected ASN	346
Peak traffic	2.29Tbps
Route Servers	Yes (Cisco ASR1002-HX) for IPv4 and IPv6
RPKI / MANRS	Yes (both)
Remarks	Website: https://www.hkix.net PeeringDB: https://www.peeringdb.com/ix/42 Resellers: https://www.hkix.net/hkix/Resellers.htm

For enquiries, please email us at info@hkix.net



Thank you!

For enquiries, please contact us at
info@hkix.net