

glow

generative linguistics in the old world

Proceedings of The 13th Generative Linguistics in The Old World in Asia (GLOW in Asia XIII) 2022 Online Special

Edited by Yuqiao Du, Zhuo Chen, Xiangyu Li, Zetao Xu, Victor Junnan Pan

August 4 - 7, 2022

The Chinese University of Hong Kong

Hosted by

Department of Linguistics and Modern Languages
The Chinese University of Hong Kong

With the support of Faculty of Arts, The Chinese University of Hong Kong

Hosted by:



Department of
Linguistics and Modern Languages
語言學及現代語言系



Conference Website

The 13th Generative Linguistics in the Old World in Asia (GLOW in Asia XIII) 2022 Online Special

Dates: August 4-7, 2022

The Chinese University of Hong Kong

Keynote Speakers

- Main Session:

Željko Bošković (University of Connecticut)

Ayesha Kidwai (Jawaharlal Nehru University)

Caterina Donati (Université Paris Cité)

Rajesh Bhatt (University of Massachusetts Amherst)

- Workshop: Workspace, MERGE, and Labelling

Mamoru Saito (Notre Dame Seishin University)

Hosted by

Department of Linguistics and Modern Languages

The Chinese University of Hong Kong

With the support of Faculty of Arts, The Chinese University of Hong Kong

GLOW in Asia XIII Organizing Committee

Victor Junnan Pan
Yuqiao Du
Zhuo Chen
Xiangyu Li
Zetao Xu

Acknowledgement

This conference could not have been possible without the participation and assistance of so many people, especially our anonymous reviewers, whose names may not all be enumerated here. Their contributions are sincerely appreciated and gratefully acknowledged. Also, the organizers of GLOW in Asia XIII would like to express our special gratitude to the session chairs (not in any particular order): Masao Ochi (Osaka University), Dongwoo Park (Korea National Open University), Niina Ning Zhang (National Chung Cheng University), Thomas Hun-tak Lee (Chinese University of Hong Kong), Michael Barrie (Sogang University), Jong Un Park (Hansung University), Jen Ting (National Taiwan Normal University), Hedde Zeijlstra (Georg August University in Göttingen), Sze Wing Tang (Chinese University of Hong Kong), Wei-Tien Dylan Tsai (National Tsing Hua University), Duk-Ho An (Konkuk University), Daeho Chung (Hanyang University), Yosuke Sato (Tsuda University), Sun-Woong Kim (Kwangwoon University), Myung-Kwan Park (Dongguk University), Hee-Don Ahn (Konkuk University), Nobu Goto (Toyo University), Hideki Kishimoto (Kobe University).

Finally, we would like to give our heartfelt thanks to the following colleagues: Prof. Mamoru Saito from the University of Notre Dame, Prof. Anoop Mahajan from University of California Los Angeles, Prof. Željko Bošković from the University of Connecticut, Prof. Myungkwan Park from Dongguk University, and Prof. Michael Barrie from Sogang University; The conference would not have enjoyed such a smooth progress without their altruistic contributions with the organization.

Proceedings of the 13th Generative Linguistics in the Old World in Asia (*GLOW in Asia XIII*) 2022 Online Special

First published in 2022

Published by Department of Linguistics and Modern Languages,
The Chinese University of Hong Kong.

PREFACE

This volume contains regular talks and flash-talks presented at the 13th Generative Linguistics in the Old World in Asia (GLOW in Asia XIII) 2022 Online Special, Hong Kong, on August 4-7, 2022.

Following the successful hosting of GLOW in Asia VI at the Chinese University of Hong Kong in 2007, we are once again honored to host GLOW in Asia XIII. Although the conference had to opt for an online mode due to the pandemic crisis, we received a substantial number of abstracts from all over the world. A total of 23 regular and 15 flash-talk presentations were selected and presented during the three-day Main Session of the conference, and 9 regular talks were delivered during the Workshop on Workspace, MERGE and Labeling. All of the talks represented most up-to-date research findings in a wide range of subfields in generative linguistics.

We were privileged to have five distinguished scholars to present their research as the keynote speeches (in presentation orders): Željko Bošković (University of Connecticut), Ayesha Kidwai (Jawaharlal Nehru University), Caterina Donati (Université Paris Cité), Rajesh Bhatt (University of Massachusetts Amherst), Mamoru Saito (Notre Dame Seishin University).

The conference drew over 400 participants and we had excellent discussions throughout the four days. We thank the Chinese University of Hong Kong for their generous funding; we would also like to thank Prof. Mamoru Saito from the University of Notre Dame, Prof. Anoop Mahajan from University of California Los Angeles, Prof. Željko Bošković from the University of Connecticut, Prof. Myungkwan Park from Dongguk University, and Prof. Michael Barrie from Sogang University, as well as other GLOW executive members for sharing their expertise and assisting the organization GLOW in Asia XIII. Finally, we express our deepest gratitude to the abstract reviewers who have contributed to the overall quality of the conference.

The GLOW in Asia XIII Organizing Committee

Chair: Victor Junnan Pan

Members: Yuqiao Du

Zhuo Chen

Xiangyu Li

Zetao Xu

Content

| | |
|---------------------------------------------------------------------------------------------------------------------------------|------------|
| 1.ON THE LOCALITY OF A-SCRAMBLING IN JAPANESE <i>Akihiko Arano</i> | 1 |
| 2.TWO DIMENSIONS OF AUSTRONESIAN VOICE <i>Edith Aldridge</i> | 17 |
| 3.DERIVING PERSON-BASED DIFFERENTIAL ARGUMENT MARKING IN IK <i>Penelope Danial</i> | 33 |
| 4.AUTO-CLASSIFIERS IN THAI: A POST-SYNTACTIC REDUPLICATION ACCOUNT <i>Éva Dékány</i> | 48 |
| 5.HYPER-RAISING AND THE SUBJECT POSITION IN BRAZILIAN PORTUGUESE <i>Tarcisio Dias</i> | 59 |
| 6.PSEUDO-INCORPORATION VS. DIFFERENTIAL ARGUMENT MARKING IN KOREAN <i>Imke Driemel and Hyunjung Lee</i> | 75 |
| 7.DISSOLVING MATCHING <i>Shrayana Haldar</i> | 91 |
| 8.ACCESSIBILITY ON RECONSTRUCTION: JAPANESE HEAD-EXTERNAL RELATIVE CLAUSES BY FORM COPY <i>Norimasa Hayashi</i> | 106 |
| 9.THE GLOBAL LICENSING OF JAPANESE EXPLETIVE NEGATION <i>Shun Ihara</i> | 117 |
| 10.ASPECT IN HINDI-URDU AND TRANSITION BETWEEN SYNTACTIC DOMAINS <i>Gurmeet Kaur and Julie Goncharov</i> | 133 |
| 11.ASYMMETRY IN POSSESSOR-AGREEMENT IN MAITHILI <i>Preeti Kumari and Pritha Chandra</i> | 149 |

| | |
|------------------------------------------------------------------------------------------------------------------------------------------------|-----|
| 12.PROCESSING OF HONORIFIC AGREEMENT IN KOREAN <i>So Young Lee and Myung Hye Yoo</i> | 164 |
| 13.ARGUMENT ELLIPSIS AS TOPIC-MARKING AND A'-MOVEMENT IN JAPANESE <i>Masako Maeda</i> | 172 |
| 14.DERIVING THE CLITIC STRING BY SEQUENCE FORMATION <i>Maria Rita Manzini and Diego Pescarini</i> | 186 |
| 15.THE CATEGORIAL STATUS OF EMBEDDED QUESTIONS IN JAPANESE <i>Norio Nasu, Takayuki Akimoto, Koji Shimamura and Yusuke Yoda</i> | 197 |
| 16.LIGHT NOUNS AND EXTRACTION FROM NULL CLAUSAL ARGUMENTS <i>Shuki Otani and Yuta Tatsumi</i> | 211 |
| 17.DERIVING WORDHOOD WITHOUT WORD: WH-COMPOUND QUESTIONS IN JAPANESE AND RENUMERATION <i>Yosuke Sato and Hisako Ikawa</i> | 225 |
| 18.NONRESTRICTIVE RELATIVE CLAUSES AS A LIMITING CASE OF CP SEQUENCES <i>Yohei Takahashi</i> | 242 |
| 19.VARIETIES OF TOUGH-CONSTRUCTIONS AND FORMCOPY <i>Kensuke Takita, Masako Maeda and Taichi Nakamura</i> | 257 |
| 20.DEFINITE EXPRESSIONS FOR TENSES: MORE ANALOGY BETWEEN PRONOUNS AND TENSES <i>Yusuke Yagi</i> | 270 |
| 21.MANDARIN BRIDGING: EXPERIMENTAL DATA AND THEORETICAL IMPLICATIONS <i>Ziling Zhu and Dorothy Ahn</i> | 279 |

On the locality of A-scrambling in Japanese*

Akihiko Arano

University of Connecticut

1. Introduction

Extending Mahajan's (1990) work on Hindi scrambling, Saito (1992) and Tada (1993) argue that the notion of clause boundary plays a crucial role in the A-/A'-distinction of scrambling in Japanese. Specifically, they claim that clause-internal scrambling can be A-movement, whereas long-distance scrambling (i.e., scrambling out of a clause) is necessarily A'-movement. This asymmetry between clause-internal scrambling and long-distance scrambling can be illustrated, for example, by licensing of bound variable readings. Consider (1) and (2).

- (1) a. * *Soko_i-no syain-ga mittu-izyoo-no kaisya_i-o tyoosasita.*
 it-GEN employee-NOM three-or.more-GEN company-ACC investigated
 "Their_i employees investigated three or more companies_i."
 b. [*Mittu-izyoo-no kaisya_i-o*]₁ *soko_i-no syain-ga t₁ tyoosasita.*
 three-or.more-GEN company-ACC it-GEN employee-NOM investigated
 "[Three or more companies]_{1,i} their_i employees investigated t₁."
 (Takano 2010: 84-85)
- (2) a. * *Soko_i-no sotugyoosei-ga [Ken-ga mittu-izyoo-no daigaku_i-ni syutugansita to]*
 it-GEN graduate-NOM Ken-NOM three-or.more-GEN university-DAT applied C
 omotta.
 thought
 "Their_i graduates thought that Ken applied to three or more universities_i."
 b. * [*Mittu-izyoo-no daigaku_i-ni*]₁ *soko_i-no sotugyoosei-ga [Ken-ga t₁ syutugansita to]*
 three-or.more-GEN university-DAT it-GEN graduate-NOM Ken-NOM applied C
 omotta.
 thought
 "[To three or more universities]_{1,i} their_i graduates thought that Ken applied t₁."

In (1) and (2), there are pronouns *soko* within (matrix) subjects and they can potentially be bound by QP like 'three or more NPs' under the c-command relationship. (1) shows that the object QP can bind them as a result of clause-internal scrambling. (2), on the other hand, shows that long-distance scrambling cannot license the bound variable reading. This contrast in (1) and (2) suggests that clause-internal scrambling can be A-movement, which feeds a bound variable reading, whereas long-distance scrambling has to be A'-movement.

This A-/A'-dichotomy regarding Japanese scrambling has been widely accepted but it has often been observed that there are certain exceptions to this generalization: it has been observed that there are licit cases of long-distance A-scrambling (see Nemoto 1993, Takano 2010, Yoshimoto 2012, Funakoshi 2015, Branagan 2018). Based on these works, this paper aims to

*I would like to thank anonymous reviewers, audience at GLOW in Asia XIII and especially Željko Bošković for their comments and discussion. Any errors are, of course, my own.

establish a new generalization regarding the locality of A-scrambling in Japanese. Specifically, the paper argues for (3), a generalization regarding long-distance A-scrambling.

(3) XP can undergo long-distance A-scrambling above its next higher overt argument but no further.

The paper further suggests that the generalization in question holds not only in long-distance scrambling but also in clause-internal scrambling, that is, it holds for scrambling in general.

(4) XP can undergo A-scrambling above its next higher overt argument but no further.

(5) illustrates three abstract configurations relevant to the generalizations. In (5), Arg(ument)-3 c-commands Arg-2, which in turn c-commands a trace of Arg-1, and Arg-1 has undergone A-scrambling.

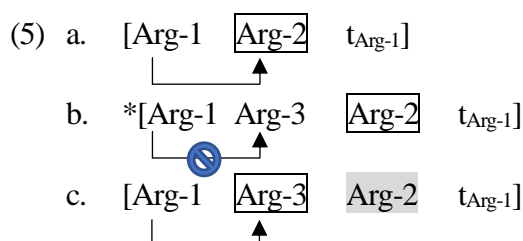

(5a) shows that Arg-1 may undergo A-scrambling to cross Arg-2. This is licit since, for Arg-1, its next higher overt argument from its base-position is Arg-2, which is expressed by a box. The status of A-scrambling will be evidenced by showing that the scrambled Arg-1 can license a bound variable reading for a pronoun inside Arg-2 (arrows express binding relations). (5b) shows that Arg-1 cannot undergo A-scrambling to cross Arg-3 (that is, the scrambled Arg-1 cannot bind into Arg-3), since its next higher overt argument is Arg-2. (5c) shows that if Arg-2 is covert, which is shown by shading, the scrambled Arg-1 can bind into Arg-3 since, in (5c), the next higher overt argument for Arg-1 is Arg-3, given that Arg-2 is covert. I argue that the covertness of Arg-2 can ensue by being PRO or pro.

I develop an analysis of A-scrambling to account for the generalization in (4). I argue that the patterns in (5a, b) can be accounted for by claiming that A-scrambling is subject to intervention effects caused by intervening arguments and that application of A-scrambling needs motivations. It is also shown that the pattern in (5c), when combined with the account of (5a, b), can be subsumed under the generalization in Bošković (2011) that traces and elided elements do not count as interveners.

The rest of the paper is organized as follows. In Section 2, we investigate scrambling out of control clauses and finite clauses. Based on Nemoto (1993), Takano (2010), and Yoshimoto (2012), it is shown that scrambling out of control clauses is subject to the generalization in (3). I also present data from Funakoshi (2015) and show that scrambling out of finite clauses is also subject to the generalization in (3). I also discuss long-distance scrambling of subjects to give a further support for the generalization. In Section 3, I discuss binding possibilities in Multiple Subject Constructions to show that there is a reason to maintain (4). In Section 4, I present an analysis of the generalization I advocate. Section 5 concludes.

2. Locality of long-distance A-scrambling

As reviewed in the introduction, the notion of clause-boundary plays a crucial role in the traditional generalization on scrambling. It has, however, been observed that certain types of cross-clausal scrambling shows A-properties. Nemoto (1993), Takano (2010), and Yoshimoto (2012) discuss such scrambling out of control clauses, and Funakoshi (2015) discusses such scrambling out of finite clauses. In this section, I synthesize the observations made in the previous literature and argue that the generalization in (3) holds for the locality of long-distance A-scrambling. It is shown that all of the patterns in (5) are observed.

Before discussing cases of long-distance scrambling, I first show that the examples which motivate the traditional generalization are subject to the generalization in (4). Hereafter, when discussing scrambling in a particular configuration, I also show the abstract representation of linguistic examples. Moved phrases are always QPs and do binding from their landing site. The next higher overt argument of a moved phrase (from its base-position) is boxed and the binding relation is expressed by arrows. (6) is the structure of (1b) and it shows that Obj crosses Subj (its next higher overt argument) and Obj binds a pronoun inside Subj successfully, conforming to the generalization in (4) (pattern (5a)):

(6) Clause-internal scrambling

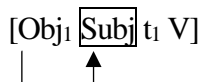

The case of long-distance scrambling ((2b)) is represented in (7), in which the object of the embedded clause undergoes long-distance scrambling. Since its next higher overt argument is the subject of the embedded clause, the binding into the matrix subject fails (pattern (5b)).

(7) Scrambling out of finite clauses

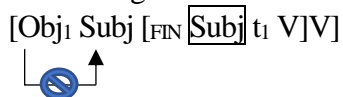

2.1 Scrambling out of control clauses

Nemoto (1993) is the first systematic study which investigates scrambling out of nonfinite/control clauses in Japanese. Building on Mahajan's (1989) work on Hindi, Nemoto claims that scrambling out of control clauses patterns with clause-internal scrambling, that is, scrambling out of control clauses is not regarded as long-distance scrambling. Takano (2010), however, argues that facts are more complicated than Nemoto's claim. Takano shows that scrambling out of control clauses sometimes shows A-properties, sometimes not.

Consider first the subject-control construction. Example (8) shows the scrambling out of control clauses involving subject-control, and the extracted object from the embedded clause can bind into a matrix subject.

- (8) [Mittu-izyoo-no daigaku_i-ni]₁ soko_i-no sotugyoosei-ga [PRO t₁ syutugansi-yoo
 three-or.more-GEN university-DAT that.place-GEN graduate-NOM apply-will
 to] sita.
 that did
 "[To three or more universities]_{1,i} their_i graduates tried to apply t₁."

This fact is an instantiation of the pattern in (5c). Since the embedded subject is PRO and therefore covert, the next higher overt argument of the embedded object is the matrix subject. The scrambled object can thus bind into the matrix subject.

(9) Scrambling out of control clauses with subject-control predicates



Let us now turn to object-control constructions. Takano (2010) shows that there is an asymmetry between matrix subjects and matrix objects regarding binding into them. As (10) shows, when the object is scrambled out of control clauses, it can bind a pronoun inside a matrix object, but not a pronoun inside a matrix subject:

(10) a. Binding into Subj

?*[Mittu-izyoo-no daigaku_i-ni]₁ soko_i-no sotugyoosei-ga Ken-ni [PRO t₁ syutugansuru
 three-or.more-GEN university-DAT it-GEN graduate-NOM Ken-DAT apply
 yoo(ni)] susumeta.
 C recommended

"[To three or more universities]_{1,i} their_i graduates recommended to Ken that he apply t₁."

b. Binding into Obj

?*[Mittu-izyoo-no daigaku_i-ni]₁ Ken-ga soko_i-no sotugyoosei-ni [PRO t₁ syutugansuru
 three-or.more-GEN university-DAT Ken-NOM it-GEN graduate-DAT apply
 yoo(ni)] susumeta.
 C recommended

" [To three or more universities]_{1,i} Ken recommended to their_i graduates that they apply t₁."

(Takano 2010: 87, 88)

As Takano (2010) points out, this contrast shows that it is not the case that control clauses are simply transparent for A-scrambling. If they were, both of the examples in (10) would be acceptable. The contrast in question falls under the generalization I advocate. In the object-control construction, there are a matrix object as well as a matrix subject. Therefore, the next higher overt argument of the object in the embedded clause is a matrix object, and only the binding into it is allowed.

(11) Scrambling out of control clauses with object-control predicates

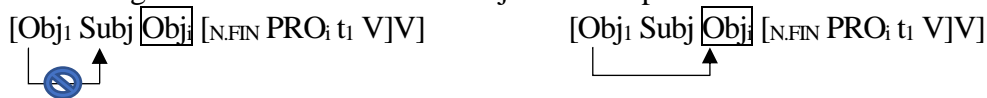

Let us turn to the third type of control construction, a *promise*-type. It is a subject-control construction with a matrix object. Structurally speaking, this construction has the same structure as the object-control construction, and, as my generalization expects, they show the same properties regarding binding. As Yoshimoto (2012) observes, the extracted object out of

control clauses can bind into a matrix object but not into a matrix subject:^{1,2}

(12) a. Binding into Subj

?*[Mittu-izyoo-no kaisya-i-o]₁ soko-i-no syain-ga Ken-to [PRO t₁
 three-or.more-GEN company-ACC it-GEN employee-NOM Ken-with
 tyoosasuru to] yakusokusita.
 investigate that promised
 "[Three or more companies]_{1,i} their_i employees promised Ken to investigate t₁."

b. Binding into Obj

[Mittu-izyoo-no kaisya-i-o]₁ Ken-ga soko-i-no syain-to [PRO t₁
 three-or.more-GEN company-ACC Ken-NOM it-GEN employee-with
 tyoosasuru to] yakusokusita.
 investigate that promised
 "[Three or more companies]_{1,i} Ken promised their_i employees to investigate t₁."

(13) Scrambling out of control clauses with *promise*-type predicates

[Obj]₁ Subj_i [Obj]_i [N.FIN PRO_i t₁ V]V [Obj]₁ Subj_i [Obj]_i [N.FIN PRO_i t₁ V]V

To summarize so far, I have investigated the binding possibilities in the control constructions in detail. What we found can be stated as in (14):

(14) An XP can undergo long-distance A-scrambling out of control clauses above its next higher overt argument but no further.

In the next section, we turn to cases of long-distance scrambling out of finite clauses. Drawing on Funakoshi (2015), I argue that the same generalization holds in those cases as well. I also present arguments from long-distance scrambling of subjects to support the generalization.

2.2 Scrambling out of finite clauses

As we have seen in (2b), long-distance A-scrambling is not allowed from an embedded clause with an overt subject. Because of the presence of the embedded subject, the next higher overt argument for the embedded object is the embedded subject. Funakoshi (2015) argues that different patterns emerge when subjects of embedded clauses are covert. Funakoshi also notes that the presence or absence of matrix datives makes a difference here. Consider first cases with a matrix dative argument. When there are a covert subject in the finite embedded clause and a dative in the matrix clause, the matrix dative allows binding into it but the matrix subject does not. This is shown in (15) (For concreteness, I represent empty arguments as *pro*):

¹ In the *promise*-type construction presented in (12), the matrix object is marked by *-to* 'with' (rather than by *-ni* 'to'). This is what Fujii (2006) calls the comitative-marked "*promise*." He argues that this type of *promise* displays the diagnostic properties of obligatory control.

² This pattern poses a problem to the generalization Takano proposes regarding scrambling out of control clauses. His generalization is (i):
 (i) Scrambling out of a control clause makes variable binding possible only if the pronominal is contained in the controller.

In (12), the controller of PRO is the subject but only the binding into the matrix object is allowed.

(15) a. Binding into Subj

*[Mittu-izyoo-no daigaku_{ii}-o]₁ soko_{ii}-no sotugyoosei_i-ga Ken_{iii}-ni [pro_{i,iv} (izure) t₁
 three-or.more-GEN university-ACC it-GEN graduate-NOM Ken-DAT soon
 tyoosasuru-tumori-da to] itta.
 investigate-will-COP that said
 "[Three or more universities]_{1,i} their_i graduates said to Ken that pro will investigate t₁."

b. Binding into Obj

?[Mittu-izyoo-no daigaku_{ii}-o]₁ Ken-ga soko_{ii}-no sotugyoosei_i-ni [pro_{i,iv} (izure) t₁
 three-or.more-GEN university-ACC Ken-NOM it-GEN graduate-DAT soon
 tyoosasuru-tumori-da to] itta.
 investigate-will-COP that said
 "[Three or more universities]_{1,i} Ken said to their_i graduates that pro will investigate t₁."
 (Funakoshi 2015: 326, 379)

This pattern is illustrated in (16).

(16) Scrambling out of finite-clauses with matrix datives and covert embedded subjects



(16) conforms to my generalization, and it is quite similar to what we have seen in the object-control and *promise*-type constructions ((11) and (13)). In all of these cases, subjects in the embedded clauses are phonologically empty and the matrix dative is the next higher overt argument of the embedded object.

Having looked at the cases with matrix datives, consider cases without them. The absence of matrix datives and the covertness of embedded subjects make the matrix subject the next higher overt argument of the embedded object. Thus, when the embedded object is scrambled above the matrix subject, binding into it is possible:

(17) ?[Mittu-izyoo-no kaisya_{ii}-ni]₁ [soko_{ii}-no raibaru-gaisya-no syaini]-ga
 three-or.more-GEN company-DAT that.place-GEN rival-company-GEN employee-NOM
 [pro_{i,iii} (izure) t₁ oobosuru-tumori-da to] omotteiru.
 soon apply-will-COP C think
 "[To three or more companies]_{1,i} employees of their_i rival companies think that *pro* will apply t₁."
 (adapted from Funakoshi 2015: 328)

(18) Scrambling out of finite clauses with no matrix objects or overt embedded subjects

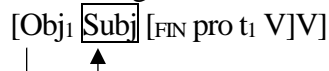

Note that this is the same situation as we saw in the subject-control construction ((9)), if we abstract away from types of embedded clauses and embedded covert subjects.

Finally, as another kind of support for the generalization, I consider long-distance scrambling of subjects. Its structure is shown below:

(19) Long-distance scrambling of subjects out of finite-clauses

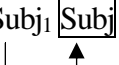
[Sub]_{j1} [Sub] [FIN t₁ Obj V]V

Note that, for embedded subjects, the next higher overt argument is the matrix subject since they are the highest argument in the embedded clause. My generalization then expects that scrambled embedded subjects can bind into the matrix subject as a result of long-distance scrambling, as in (19).³ I argue that this is the case by looking at the construction discussed by Takahashi and Uchibori (2003).

Takahashi and Uchibori (2003) discuss the alternation in (20).

- (20) a. Huziko-ni(-wa) [CP Yawara-ga kin medaru-o toru to] omoeta.
 Fujiko-DAT(-TOP) Yawara-NOM gold medal-ACC win that seemed
 "It seemed to Fujiko that Yawara would win a gold medal."
 b. Yawara-ga₁ Huziko-ni(-wa) [CP t₁ kin medaru-o toru to] omoeta.
 Yawara-NOM Fujiko-DAT(-TOP) gold medal-ACC win that seemed
 "lit. Yawara seemed to Fujiko that t₁ would win a gold medal."
 (Takahashi and Uchibori 2003: 302)

In (20), the verb *omoe* 'seem' takes a dative subject and a finite clause complement and the alternation involves displacement of the embedded subject out of the embedded clause. Takahashi and Uchibori argue that this alternation involves movement. For example, they show that idiomatic interpretation is retained under this alternation. Consider (21).

- (21) a. Siraha-no ya-ga Yawara-ni tatta.
 white.feather-GEN arrow-NOM Yawara-DAT stood
 "Yawara was nominated."
 b. [Siraha-no ya-ga]₁ Huziko-ni(-wa) [t₁ Yawara-ni tatu to] omoeta.
 white.feather-GEN arrow-NOM Fujiko-DAT(-TOP) Yawara-DAT stand that seemed
 "It seemed to Fujiko that Yawara would be nominated."
 (Takahashi and Uchibori 2003: 302)

(21a) is an idiomatic expression *siraha-no ya-ga X-ni tat*, whose meaning is 'X be nominated.' This reading is available in (21b) too, which shows that the nominative idiom chunk has been moved out of the embedded clause.

Takahashi and Uchibori call this movement pseudoraising since, they argue, this

³ Saito (1985) notes that long-distance scrambling of nominative subjects is impossible in (i). The strings in (i) has to mean that Hana said that Mari ate apples, rather than Mari said that Hana ate apples, which would be possible if the nominative subject in the embedded clause were moved from the embedded clause.

(i) *Hana-ga₁ Mari-ga [t₁ ringo-o tabeta to] itta.
 Hana-NOM Mari-NOM apple-ACC ate that said
 "lit. Hana₁ Mari said that t₁ ate an apple."

Saito (1985) argues that nominative subjects cannot be scrambled because of syntactic reasons. It has, however, often been suggested that unacceptability of (i) is not due to syntactic constraints, rather to a processing difficulty (see Mihara 1994, Oku 1998, Kuno 2003; see also Kuno 1980a,b). The problem is that both the matrix verb and the embedded verb take a nominative subject. Since the first nominative phrase is likely to be interpreted as a subject of the matrix verb, it is difficult to interpret it as the subject of the embedded clause. The construction discussed below does not suffer from this difficulty since the matrix argument is a dative.

movement is different from both raising and scrambling. Pseudoraising differs from raising in that pseudoraised phrases do not show the status of derived subjects. They make this point using the licensing of *zibun* and honorification. Here I repeat their arguments regarding the licensing of *zibun*. *Zibun* is a reflexive which shows the subject-orientation (Kuroda 1965). As (22) shows, only the subject can be its antecedent.

- (22) Mari_i-ga Taro_j-ni zibun_{i/sj}-nituite hanasita.
 Mari-NOM Taro-DAT self-about told
 "lit. Mari_i told Taro_j about self_{i/sj}."

Crucially, pseudoraised subjects cannot be an antecedent of *zibun* inside a matrix dative, which shows that pseudoraised subjects are not matrix subjects.

- (23) *Yawara-ga₁ zibun-no hahaoya-ni [_{CP} t₁ kin medaru-o toru to] omoeta.
 Yawara-NOM self-GEN mother-DAT gold medal-ACC win that seemed
 "lit. Yawara seemed to the mother of herself that t₁ would win a gold medal."
 (Takahashi and Uchibori 2003: 307)

Takahashi and Uchibori argue that pseudoraising is also distinct from scrambling using data like (24).

- (24) [Mittu-izyoo-no daigaku_i-ga]₁ soko_i-no sotugyoosei-ni [t₁ yoi daigaku-da
 three-or.more-GEN university-NOM that.place-GEN graduate-DAT good university-COP
 to] omoeta.
 that seemed
 "lit. [Three or more universities]_{1,i} seemed to their_i graduates that t₁ are good universities"

(24) shows that the pseudoraised subject can bind into the matrix dative, that is, it shows the A-property. Takahashi and Uchibori take this fact as evidence against pseudoraising as scrambling, since they assume the traditional generalization that scrambling out of finite clauses is necessarily A'-scrambling. However, we have already seen that long-distance A-scrambling is allowed in certain situations. In fact, from the perspective of the generalization defended here, this is the configuration in which long-distance A-scrambling should be allowed: the next higher overt argument of the embedded subject is the matrix subject. I thus argue that movement of subjects in question should be analyzed as licit long-distance A-scrambling of nominative subjects, rather than pseudoraising, a raising process which is proposed just for this construction.⁴

To summarize, I have reviewed Funakoshi's (2015) observation regarding scrambling out of finite clauses with pro subjects, presented the cases of binding under long-distance scrambling of subjects, and, by unifying these, argued for (25):

⁴ It is not the case that the finite clause in 'pseudoraising' is totally transparent for A-scrambling. When the object is extracted from there, binding into the dative is impossible:





- (i) *[Mittu-izyoo-no daigaku_i-o]₁ soko_i-no sotugyoosei-ni [Ken-ga t₁ hihansita to] omoeta.
 three-or.more-GEN university-ACC that.place-GEN graduate-DAT Ken-NOM criticized that seemed
 'lit. [Three or more universities]_{1,i} it seemed to their_i graduates that Ken criticized t₁.'

This is also consistent with my generalization.

- (25) An XP can undergo long-distance A-scrambling out of finite clauses above its next higher overt argument but no further.

2.3 Interim summary

(26) is a summary of the configurations we have looked into regarding binding possibilities. I abstract away the (non-)finiteness of the embedded clause, types of control, and the PRO vs. pro distinction in empty categories from structures since they do not make a difference.

- (26) a. [Obj₁ Subj [Subj t₁ V]V] ((7))

- b. [Obj₁ Subj [[e] t₁ V]V] ((9),(18))

- c. [Obj₁ Subj Obj [[e] t₁ V]V] ((11),(13),(16)) [Obj₁ Subj Obj [[e] t₁ V]V] ((11),(13),(16))

- d. [Subj₁ Subj [t₁ Obj V]V] ((19))

All of these cases are unified under the single generalization.

- (27) An XP can undergo long-distance A-scrambling above its next higher overt argument but no further.

Note that (27) is the generalization regarding long-distance A-scrambling. In the next section, I pursue the possibility that the generalization in question holds for A-scrambling in general, not just long-distance A-scrambling.

3. Clause-internal non-A-scrambling

In this section we investigate whether the generalization in question holds for clause-internal scrambling. For that purpose, we use the multiple subject construction. In Japanese, it is possible to have two (or more) nominative subjects in a single clause, as shown in (28) (it is also possible to have a single subject by associating the two noun phrases using a genitive).

- (28) [Taro-ga]_{Subj1} [musume-ga]_{Subj2} booru-o nageta.
 Taro-NOM daughter-NOM ball-ACC threw
 "Taro's daughter threw a ball."
 cf. [Taro-no musume-ga]_{Subj} booru-o nageta.
 Taro-GEN daughter-NOM ball-ACC threw

I mark the higher nominative Subj1 and the lower subject Subj2 and we will see if binding into these subjects is allowed by a scrambled object.

Consider first binding into Subj2, the lower subject. This case is shown in (29), in which Subj1 is "Sony" and Subj2 is "its employees."

- (29) a. [Mittu-izyoo-no busyo_i-o]₁ [Sony-ga]_{Subj1} [soko_i-no syain-ga]_{Subj2} t₁ tyoosasita.
 three-or.more-GEN department-ACC Sony-NOM it-GEN employee-NOM investigated
 b. [Sony-ga]_{Subj1} [mittu-izyoo-no busyo_i-o]₁ [soko_i-no syain-ga]_{Subj2} t₁ tyoosasita.
 Sony-NOM three-or.more-GEN department-ACC it-GEN employee-NOM investigated
 "[Three or more departments]_{1,i} Sony's employees of there_i investigated t₁."

In (29a) and (29b), the scrambled object has landed before Subj1 and between Subj1 and Subj2, respectively. In both of these cases, the scrambled object can bind the pronoun inside Subj2. This is consistent with the generalization since, for the object, its next higher overt argument is Subj2.

Consider now binding into Subj1, the higher subject. This case is presented in (30), in which Subj1 and Subj2 are "its presidents" and "daughters," respectively.

- (30) ?*[Mittu-izyoo-no kaisya_i-ni]₁ [soko_i-no syatyoo-ga]_{Subj1} [musume-ga]_{Subj2} t₁
 three-or.more-GEN company-DAT it-GEN president-NOM daughter-NOM
 nyuusyasyita.
 joined.company
 "[Three or more companies]_{1,i} its_i presidents' daughters joined t₁."

(30) shows that the scrambled object cannot bind into Subj1.⁵ This also conforms to the generalization: for the object, its next higher overt argument is Subj2, not Subj1. It is worth noting that a genitive counterpart of (30) allows binding, as shown in (31).

- (31) [Mittu-izyoo-no kaisya_i-ni]₁ [soko_i-no syatyoo-no musume-ga]_{Subj} t₁ nyuusyasyita.
 three-or.more-GEN company-DAT it-GEN president-GEN daughter-NOM joined.company
 "[Three or more companies]_{1,i} its_i presidents' daughters joined t₁."

The contrast between (30) and (31) suggests that what makes binding in (30) impossible is the presence of the lower subject: its presence makes Subj1 not the next higher overt argument for the object. The patterns we have observed are summarized in (32).

(32) Multiple Subject Constructions



In this section we have seen binding possibilities in Multiple Subject Constructions. What we have observed suggests that the generalization in question holds not only for long-distance scrambling but also clause-internal scrambling, that is, scrambling in general.⁶ From these considerations, I propose (4), repeated here as (33), and give an account of it in the next section.

- (33) XP can undergo A-scrambling above its next higher overt argument but no further.

⁵ One of the reviewers does not agree with the judgment in (30) and finds it to be acceptable. I checked (30) with five speakers and all of them agree with my judgment. I leave the issue of speaker variation for future research.

⁶ A potential counterexample is DO's binding into Subj in the DO-Subj-IO-t DO-V configuration. However, there is a proposal that the DO-IO order is a possible base-structure (Miyagawa 1997). Also, there is a possibility that DO moves over IO independent of scrambling, for example, by Object Shift. Therefore, I put this case aside.

4. Account

In this section, I give an account of (33), which subsumes the patterns illustrated in (34).

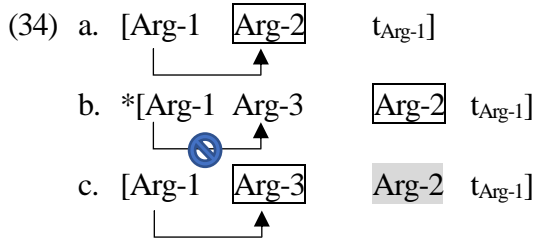

(34a) and (34b) show that A-scrambling can cross one overt argument but not two. (34c) shows that covert arguments do not count for the locality of A-scrambling. The two properties of A-scrambling in (35) needs to be accounted for:

- (35) a. Only one overt argument can be crossed.
- b. Covert arguments do not count.

I argue that (35a) is to be accounted for by the following assumptions regarding the locality and the motivation of A-scrambling. First, A-scrambling is subject to locality effects (Rizzi 1990, Chomsky 1995) and therefore arguments act as interveners for A-scrambling. I also assume equidistance (Chomsky 1995) as a strategy of avoiding intervention effects. For concreteness, I assume (36) and (37):

- (36) γ intervenes between α and β iff α c-commands γ and γ c-commands β , and γ and α are not equidistant from β .
- (37) α and β are equidistant from γ if they are in the same maximal projection.

These assumptions prohibit A-scrambling of ZP in (38), in which ZP crosses Arg via A-scrambling. This is illicit because Arg intervenes between ZP and t_{ZP}. Note that ZP and Arg are not equidistant from t_{ZP} since they belong to different maximal projections.

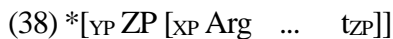

For ZP to move across Arg via A-scrambling, it first needs to land within XP to utilize equidistance effects, as shown in (39). The first movement of ZP here does not show intervention effects since t_{ZP} in the edge of XP is equidistant with Arg.

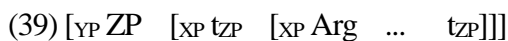

Second, I assume that application of A-scrambling needs motivations and that licensing a bound variable reading can be motivations. This can be related to the proposals that scrambling is an overt counterpart of QR (Johnson 2000, Miyagawa 2006, 2011) and that QR is subject to Scope Economy (Fox 2000). The gist of Scope Economy is that "scope-shifting operations ... are allowed to apply only when they are necessary to achieve a designated semantic interpretation (Fox 2000: 3)." My suggestion is that as an overt counterpart of QR, A-scrambling is subject to the same kind of economy and licensing a bound variable reading can

be motivations for its application.

Given these assumptions regarding the locality and motivations of A-scrambling, let us go back to the first two patterns of the generalization.

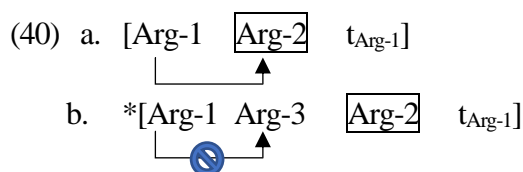

In (40a), the scrambled Arg-1 binds into Arg-2. This means that there is a motivation for A-scrambling. By utilizing the equidistance effect shown in (39), Arg-1 can cross Arg-2 via A-scrambling. In (40b), the binding relation is between Arg-1 and Arg-3. There are two derivational possibilities to consider here. The first is the scenario in which Arg-1 crosses Arg-2 and Arg-3 in one step. In this derivation, the movement has a motivation for A-scrambling but this movement is excluded because Arg-2 intervenes between Arg-1 and t_{Arg-1}. The second derivation involves successive-cyclic movement of Arg-1.

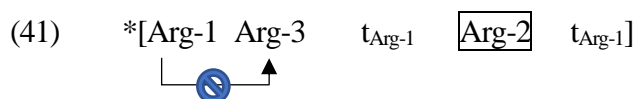

Crucially, Arg-1 does not bind into Arg-2. This means that there is no motivation for A-scrambling in the first step and therefore A'-scrambling has to be used. Since the first step of movement is necessarily A'-movement, the following step also has to be A'-movement because of the improper movement. Thus, there are no licit ways to establish a binding relation when scrambled phrases cross two (or more) overt arguments.⁷

The remaining issue is why covert arguments do not count for the locality of A-scrambling.



I would like to suggest that this point is related to the generalization argued for by Bošković (2011). He argues for (43):

(43) Traces and elided elements do not count as interveners.

Since Ross's (1969) seminal work, it is well-known that certain locality violations can be ameliorated by applying ellipsis. For example, movement out of islands can be rescued by applying sluicing. This is shown in (44):

⁷ For this analysis to work for the pattern in the Multiple Subject Constructions ((32)), multiple subjects need to belong in different projections. If they occupied multiple specifiers of the same projection, as argued by Fukui (1986) and Kuroda (1988), they would be equidistant and therefore the locality problem would not arise when the scrambled object crosses both of them. I therefore assume that multiple subjects are in different projections (see Akiyama 2004 and Yamada 2013 for such analyses.)

- (44) a. *Ben will be mad if Abby talks to one of the teachers, but she couldn't remember which (of the teachers) Ben will be mad if she talks to.
 b. Ben will be mad if Abby talks to one of the teachers, but she couldn't remember which.
 (Merchant 2001:88)

The PF-deletion account of this improvement (Merchant 2001 a.o.) claims that a locality violation is marked on islands when the violation occurs and the violation-marking is relevant to the PF-side. When islands do not get deleted, the violation-marking remains and ungrammaticality ensues. When islands get deleted, the marking is also deleted and there are no problems in the final PF representation. Bošković (2011) proposes to extend this account to the generalization that traces do not count as interveners for relativized minimality effects. Consider (45), which illustrates raising with experiencers in Italian:

- (45) a. *Gianni_i sembra a Maria [t_i essere stanco].
 Gianni seems to Maria to.be ill
 "Gianni seems to Maria to be ill."
 b. A Maria_j, Gianni_i sembra t_j [t_i essere stanco].
 to Maria Gianni seems to.be ill
 "To Maria, Gianni seems to be ill."

(45a) shows that an experiencer induces intervention effects in Italian raising and (45b) shows that such effects disappear when that experiencer moves before the raised subject. Bošković (2011) argues that the PF-deletion mechanism of island repair noted above can be employed here under the copy theory of movement (Chomsky 1995). Under the copy theory of movement, what is represented as traces is in fact copies of moved phrases. What is crucial here is the lower copy has to be deleted at PF. Suppose that a violation of relativized minimality effects is marked on interveners. This means that the violation in (45b) is marked on the lower copy of *a Maria*. Since the lower copy of the moved *a Maria* gets deleted at PF, the violation also disappears. The amelioration effects in (44) and (45) can be given a unified account in terms of PF-deletion.

We are now in a position to address the question why covert arguments do not count for the locality of A-scrambling. Recall that we have seen that pro and PRO are not regarded as crossed arguments. For pro, I suggest that they can in fact be derived by ellipsis. It is well-known that Japanese allows Argument Ellipsis (Oku 1998, Saito 2007 a.o.). Since what I have represented as pro can be derived via Argument Ellipsis, they can be deleted together with the violation marking put on them. As for the analysis of PRO, I assume the movement theory of control (Hornstein 1999 a.o.). Under this theory, PRO and its controllers are associated via movement relations and PRO are in fact a trace (or a copy which gets deleted at PF). Therefore, PRO undergoes deletion and violations marked on it gets deleted too.

5. Conclusion

This paper has investigated the locality of A-scrambling. Contrary to the traditional generalization, in which the clause-boundary plays an important role, it has argued for (46), by looking at scrambling out of control clauses, scrambling out of finite clauses, long-distance scrambling of subjects and scrambling in the multiple subject construction:

(46) XP can undergo A-scrambling above its next higher overt argument but no further.

To account for (46), this paper has developed an analysis of A-scrambling in which A-scrambling is subject to locality effects, application of A-scrambling needs motivations and deletion remedies violations of locality problems.

References

- Akiyama, Masahiro. 2004. Multiple nominative constructions in Japanese and economy. *Linguistic Inquiry* 24: 671-683.
- Bošković, Željko. 2011. Rescue by PF deletion, traces as (non)interveners, and the *that*-trace effect. *Linguistic Inquiry* 42:1-44.
- Branan, Kenyon. 2018. The ι -boundedness of A-scrambling. In *Proceedings of the 13th Workshop on Altaic Formal Linguistics (WAFL13)*, ed. Celeste Guillemot, Tomoyuki Yoshida, & Seunghun J. Lee, 127-139. Cambridge, MA: MITWPL.
- Chomsky, Noam. 1995. *The minimalist program*. Cambridge, MA: MIT Press.
- Fox, Danny. 2000. *Economy and semantic interpretation*. Cambridge, MA: MIT Press.
- Fujii, Tomohiro. 2006. Some theoretical issues in Japanese control. Doctoral Dissertation, University of Maryland.
- Fukui, Naoki. 1986. A theory of category projection and its application. Doctoral Dissertation, Massachusetts Institute of Technology, Cambridge, MA.
- Funakoshi, Sayaka. 2015. A theory of generalized pied-piping. Doctoral Dissertation, University of Maryland, College Park.
- Hornstein, Norbert. 1999. Movement and control. *Linguistic Inquiry* 30:69-96.
- Johnson, Kyle. 2000. How far will quantifiers go? In *Step by step*, ed. Roger Martin, David Michaels, & Juan Uriagereka, 187-210. Cambridge, MA: MIT Press.
- Kuno, Masakazu. 2003. Scrambling in Japanese as pure Merge. *Language Research* 19:45-78.
- Kuno, Susumu. 1980a. A note on Tonioko's intra-subjectivization hypothesis. In *Theoretical issues in Japanese linguistics*, ed. Yukio Otsu & Ann Farmer, 149-156. Cambridge, MA: MITWPL.
- Kuno, Susumu. 1980b. A further note on Tonioko's intra-subjectivization hypothesis. In *Theoretical issues in Japanese linguistics*, ed. Yukio Otsu & Ann Farmer, 171-184. Cambridge, MA: MITWPL.
- Kuroda, Sige-Yuki. 1965. Generative grammatical studies in the Japanese language. Doctoral Dissertation, MIT, Cambridge, MA.
- Kuroda, Sige-Yuki. 1988. Whether we agree or not: A comparative syntax of English and Japanese. *Linguisticae Investigationes* 12:1-47.
- Mahajan, Anoop. 1989. On the A/A-bar distinction: Scrambling and weak crossover in Hindi. Ms., MIT, Cambridge, MA.
- Mahajan, Anoop. 1990. The A/A-bar distinction and movement theory. Doctoral Dissertation, MIT.
- Merchant, Jason. 2001. *The syntax of silence*. Oxford: Oxford University Press.
- Mihara, Ken-ichi. 1994. *Nihongo no togo koozoo [Syntactic structures of Japanese]*. Tokyo: Shohakusha.
- Miyagawa, Shigeru. 1997. Against optional scrambling. *Linguistic Inquiry* 28:1-25.
- Miyagawa, Shigeru. 2006. On the "undoing" property of scrambling: A response to Bošković. *Linguistic Inquiry* 37:607-624.
- Miyagawa, Shigeru. 2011. Optionality. In *The Oxford handbook of linguistic minimalism*, ed. by Cedric Boeckx, 355-376. Oxford: Oxford University Press.
- Nemoto, Naoko. 1993. Chains and case positions: A study from scrambling in Japanese. Doctoral Dissertation, University of Connecticut, Storrs.
- Oku, Satoshi. 1998. A theory of selection and reconstruction in the minimalist perspective. Doctoral Dissertation, University of Connecticut, Storrs.

- Rizzi, Luigi. 1990. *Relativized minimality*. Cambridge, MA: MIT Press.
- Ross, John Robert. 1969. Guess who? In *Papers from the Fifth Regional Meeting of the Chicago Linguistic Society*, ed. by Robert I. Binnick, Alice Davison, Georgia M. Green, and Jerry L. Morgan, 252-286. Chicago: University of Chicago, Chicago Linguistic Society.
- Saito, Mamoru. 1985. Some asymmetries in Japanese and their theoretical implications. Doctoral Dissertation, Massachusetts Institute of Technology, Cambridge, MA.
- Saito, Mamoru. 1992. Long distance scrambling in Japanese. *Journal of East Asian Linguistics* 1, 69-118.
- Saito, Mamoru. 2007. Notes on East Asian argument ellipsis. *Language Research* 43:203-227.
- Tada, Hiroaki. 1993. A/A' partition in derivation. Doctoral Dissertation, MIT.
- Takahashi, Daiko, & Asako Uchibori. 2003. Pseudoraising. *Gengo Kenkyu* 123:299-329.
- Takano, Yuji. 2010. Scrambling and control. *Linguistic Inquiry* 41:83-110.
- Yamada, Toshiyuki. 2013. On the multiple subject construction in Japanese: A cartographic approach. *Linguistic Research* 29: 93-114.
- Yoshimoto, Keisuke. 2012. Dissociating Japanese scrambling from controller movement. *IBERIA: An International Journal of Theoretical Linguistics* 4:170-200.

Two Dimensions of Austronesian Voice

Edith Aldridge

Academia Sinica

1. Introduction

Tagalog exhibits a type of ergative alignment commonly referred to as a “voice” system. The term “voice” refers to the fact that different verbal affixes reflect which argument has absolutive/nominative case. In the perfective aspect, the infix <um> indicates that the subject has nominative case, as in (1a, b). The perfective aspect marker changes to <in> when nominative case appears on an internal argument in a transitive clause. When <in> appears with no additional voice marking on the verb in a monotransitive clause, the direct object has nominative case, as in (1c). The combination of <in> and the applicative *-an* signals that the nominative argument is a goal or locative argument, as in (1d). The applicative *i-* is associated with a nominative instrument, beneficiary, or moved theme. (1e) shows an example with a moved theme.

- (1) a. D<um>ating ang babae.
 <INTR.PFV>arrive NOM woman
 ‘The woman arrived.’
- b. B<um>ili ang babae nang isda.
 <INTR.PFV>buy NOM woman OBL fish
 ‘The woman bought (a) fish.’
- c. B<in>ili ni Maria ang isda.
 <TR.PFV>buy GEN Maria NOM fish
 ‘Maria bought the fish.’
- d. B<in>igy-an ni Maria nang isda ang lalaki.
 <TR.PFV>give-APPL GEN Maria OBL fish NOM man
 ‘Maria gave the man a fish.’
- e. I-b<in>igay ni Maria ang isda sa lalaki.
 APPL-<TR.PFV>give GEN Maria NOM fish to man
 ‘Maria gave the fish to the man.’

The voice system is often analyzed as a type of agreement between the verb and the argument with nominative case (Georgopoulos 1991; Chung 1994, 1998; Pearson 2001; Rackowski 2002; Rackowski & Richards 2005; Chen 2017). However, without even considering the details of how such an agreement relation might be established, two obvious problems present themselves. First, voice marking has no uniform morphological position, surfacing as a prefix, suffix, or infix. Consequently, it would be difficult to associate this agreement with a particular functional head. Secondly, not one but two agreement reflexes appear in applicative constructions in the perfective aspect, the applicative affix and <in>. Use of <in> rather than <um> signals that an internal argument has nominative case, so it must also be treated as a type of voice marking.

In this paper, I propose a different approach based on C-T Inheritance along the lines of

Aldridge (2017a, b; 2021). This is a direct approach, obviating the agreement step, and treating each voice morpheme as a functional head on the clausal spine. The applicative heads project ApplPs (in the sense of Pytkkanen 2002), selecting the applied nominals in their specifiers. The dichotomy between in the aspect markers is a consequence of whether C-T Inheritance takes place. I propose that Inheritance is forced when multiple licensing features are merged on this phase head. The relevant features for Austronesian languages are case features. Since Tagalog is an ergative language, two cases are potentially valued in the higher phase: nominative/absolutive and genitive/ergative. In subject voice clauses, only nominative case is needed in order to license the subject, so Inheritance does not take place. But in the other voices, which are ergative clauses, both the subject and an internal argument must be licensed. This necessitates the merger of two case features on C/T, forcing the two heads to divide. Genitive is passed to T and valued on the subject, while nominative remains on C and is valued on a lower argument. In the perfective aspect, *<um>* is spelled out on unsplit C/T, i.e. in subject voice clauses. *<in>* is spelled out as perfective aspect on T after it has split from C, i.e. in ergative clauses, when an internal argument has nominative case and the subject has genitive.

| | | | | |
|---------------------------------|-------------------------------------------------|-----------------------------------------------|----------------------------------------------------|----------------------------------------------------|
| | <u>C/T</u> | ————— | <u>Separate C & T</u> | ————— |
| (2) Inheritance approach | <u>SUBJ_{NOM}</u> <i><um>V</i> | <u>DO_{NOM}</u> <i><in>V</i> | <u>GOAL_{NOM}</u> <i><in>V-an</i> | <u>INSTR_{NOM}</u> <i>i-<in>V</i> |

Section 2 introduces the C-T Inheritance framework and presents the Tagalog analysis. Section 3 provides typological support by showing how the same approach accounts for certain subject/non-subject asymmetries in other languages.

2. Tagalog analysis

2.1 Framework

Chomsky (2008) proposes that features driving the derivation are merged initially on phase heads. One consequence of this is that features for licensing the subject are not inherent to the T head but are “inherited” by T from C after C enters the derivation. For example, in the following object *wh*-question in English, both the interrogative feature to attract the *wh*-constituent and the [$u\phi$] feature to license the subject enter the derivation on C. Subsequent to this, [$u\phi$] is passed to T, attracting the subject to [Spec, TP] and valuing nominative case with it. The interrogative feature remains on C and attracts the *wh*-constituent to [Spec, CP]. T is also attracted to C and spelled out as an auxiliary verb expressing tense. If there is no auxiliary in the syntactic component, “do” will be inserted post-syntactically in order to spell out the tense feature.¹

- (3) a. **What did you** read?
 b. [_{CP} *what* [_C [u WH]] [_{TP} *you*_{[ϕ , NOM]] [_T [$u\phi$]] [_{vP} *<you>*] [_{v'} *v*] [_{VP} *read <what>*]]]]]]]}

On the other hand, Ouali (2006), Legate (2011, 2014), Gallego (2014), Erlewine (2016, 2018), Aldridge (2018, 2019), and others have argued that if only one constituent needs to value features with the phase head, then Inheritance does not need to take place, and C and T can enter the derivation as a single amalgamated head. An example of this sort is subject *wh*-

¹ The specific analysis of English “do” support is not at issue in this paper. Readers are referred to Halle and Marantz (1993), Bobaljik (1995), Lasnik (1995), among many others for some possible approaches.

questions in English. Since the subject values both the interrogative and case licensing features on C/T, these heads do not need to divide, and the subject moves to the specifier of this combined functional head. Note that “do” support is also obviated, since there is no movement of T to C.

- (4) a. [_{C/TP} **She** [_{C/T}_[u ϕ] [_{vP} <she> read that book]]].
 b. [_{C/TP} **Who** [_{C/T}_[u WH , u ϕ] [_{vP} <who> read that book]]]?

This is the implementation of C-T Inheritance that I adopt in this paper. C and T enter the derivation as a single head and divide only when necessary, i.e. when different features are checked by separate constituents. I will also argue that the division between C and T is often overtly marked. The example seen above involves auxiliary/verb movement in questions. In the next section, I propose that this role is performed by the different aspect markers in Tagalog subject and non-subject voice.

2.2 Analysis of Tagalog alignment

Subject voice clauses are derived when C/T enters the derivation with one (nominative) case feature. Since C/T enters the derivation with only one case feature, C and T do not split. The subject values nominative case, and the object is licensed internal to vP. The case valued by *v* on objects is only capable of licensing third person objects, and these typically receive indefinite, nonspecific interpretations, so I analyze it as a defective oblique case.² I discuss this case in more detail below. Finally, the verb moves to the undivided C/T head, and the aspect feature is spelled out as <um> in perfective aspect. I assume that the verb (more specifically the Asp head) is attracted by temporal features on T.

- (5) a. B<um>ili *ang* *babae* *nang* *isda*.
 <INTR.PFV>buy NOM woman OBL fish
 ‘The woman bought a fish.’

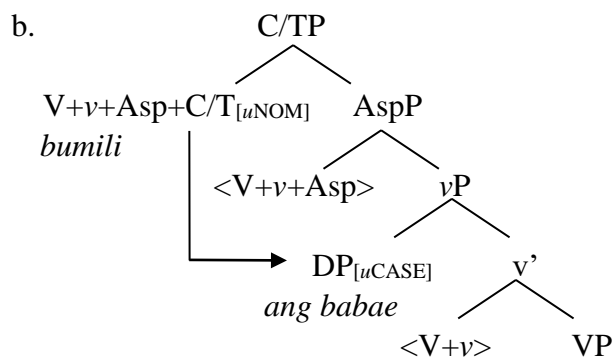

Ergative (non-subject voice) clauses are derived when C/T enters the derivation with two case features, nominative and genitive. This forces C and T to divide. T values genitive on the subject, and C values nominative on the object. Regarding how it is determined that genitive is

² I use “defective” in the sense of Richards (2008), who proposes that defective case like genitive in negated clauses in Slavic languages is not capable of valuing a person feature. Richards further assumes that definite third person DPs have a person feature, while indefinite ones do not. See also Longobardi (2008) for a connection between person features and referentiality.

valued by the lower head, while nominative remains on C, this is straightforward, since nominative case is also associated with certain deictic features. Specifically, nominative DPs in Tagalog and most other Austronesian languages spoken in Taiwan and the Philippines always have presupposed reference. In fact, they are often analyzed as topics (Schachter 1976, Richards 2000, Pearson 2001, Chen 2017, and others). The connection to definiteness/topicality is accounted for if nominative case in languages like Tagalog is valued by C rather than T. Since C-T Inheritance has taken place, the verb moves only as far as T, and the aspect feature is spelled out as *<in>* on T in the perfective aspect.

- (6) a. B<in>ili ni Maria *ang* *isda*.
 <TR.PFV>buy GEN Maria NOM fish
 ‘Maria bought the fish.’

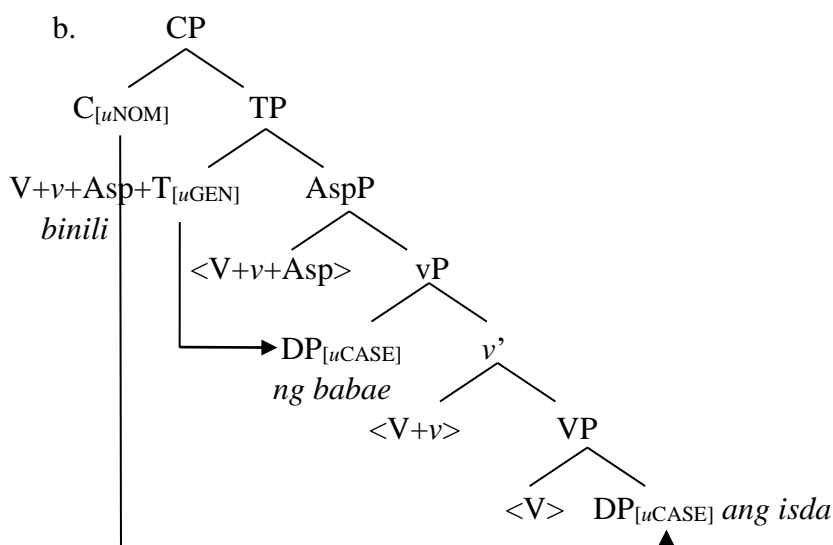

Since defective case is available for the object inside *vP*, it may be wondered why the object needs to value case again with C. This is because nominative objects in ergative clauses are either definite or have a person feature. The defective case is unable to value these features.

Applicative constructions are also ergative clause types, so they can only be derived when C/T enters with both nominative and genitive case features. Taking the locative applicative as an example, the suffix *-an* is merged in Appl and selects a goal/locative argument in its specifier.³ Although it is merged within the *c*-command domain of *v*, this argument is not eligible for oblique case and must be licensed with nominative. Cross-linguistically, it is only VP-internal arguments, specifically theme or patient arguments which value this type of defective case (Kornfilt 1984, Enç 1991, and others for Turkish; Belletti 1988 for English and Italian; Vainikka 1989 for Finnish; Pesetsky 1982, Bailyn 1997, and others for Slavic languages). One way to account for this is on the basis of their structural position, since applied objects are merged outside VP. Consequently, they receive presuppositional interpretations (as per Diesing’s 1992 Mapping Hypothesis). For this reason, both the subject and the applied object must be licensed by C/T, so these heads must divide, T valuing genitive case with the subject and C valuing nominative with the applied object. The verb will again move to T, and

³ I analyze this ApplP as a “high” applicative phrase, because the locative applicative in Tagalog is compatible with unergative VPs and consequently does not behave like a low applicative, in the sense of Pylkkanen (2002).

the aspect feature will be spelled out as *<in>* in the perfective.

- (7) a. B<in>igy-an ni Maria ang lalaki nangisda.
 <TR.PFV>give-APPL GEN Maria NOM man OBL fish
 ‘Maria gave the man a fish’.

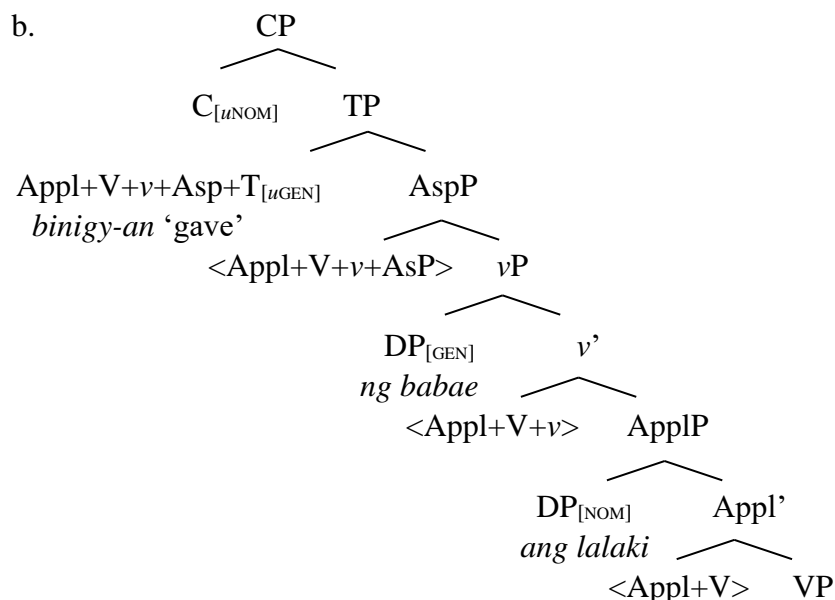

In this subsection, I proposed that C-T Inheritance must take place in order for two DPs to be licensed by C/T. A split between C and T can also have an overt morphological reflex. In Tagalog, this is manifested most clearly in the perfective aspect. The perfective marker *<um>* appears on a undivided C/T head, i.e. in subject voice constructions when only the subject DP is licensed by C/T. The aspect marker *<in>* appears in the other voices, when both the subject and an internal argument need to be licensed. The presence of two case features on C/T forces Inheritance to take place, and *<in>* is spelled out on the T head which has divided from C. The association of nominative case with deictic and/or information structural features is also accounted for by my proposal that this case is valued by C rather than T. Finally, my analysis accounts for the covariation between nominative case and particular arguments known as the Tagalog “voice system”. In addition to the correlation between subject and non-subject voice and perfective aspect marking summarized above, the applicative affixes are also associated with their corresponding arguments through selection in ApplP.

2.3 Additional evidence

This subsection provides supporting evidence for the analysis presented in section 2.2. First, I take up the proposal that the nominative DP values case with C and not T. In addition to the definiteness mentioned in the previous subsection, the defective case valued by *v* also cannot license person features. As shown in (8a, b), oblique *nang* cannot mark personal names or pronouns; these must instead be packaged as goal or locative PPs.⁴

⁴ This type of differential object marking is reminiscent of dative marking of personal objects in Romance and other languages.

- (8) a. P<um>atay=siya **nang** isa-ng tao.
 <INTR.PFV>kill=3SG.NOM OBL one-LK person
 ‘He/she killed someone.’
- b. P<um>atay=siya **kay** Maria.
 <INTR.PFV>kill=3SG.NOM to Maria
 ‘He/she killed Maria.’
- c. P<um>atay=siya **sa** kanya.
 <INTR.PFV>kill=3SG.NOM to 3SG
 ‘He/she killed him/her.’

In contrast, nominative case can license a person feature, as in (9a). This is accounted for if person features reside on the C head.⁵ The nominative case marker for personal names is *si*, while *ang* marks common NPs. (9b) shows that the goal is marked with the preposition when the argument does not value nominative case. This argument is clearly not merged in [Spec, ApplP]. The ApplP in (9b) is projected by the *i*- applicative head, in this case selecting the moved theme.

- (9) a. B<in>igy-**an** ni Maria *si* *Pedro* nang isda.
 <TR.PFV>give-APPL GEN Maria NOM Pedro OBL fish
 ‘Maria gave Pedro a fish.’
- b. I-b<in>igay ni Maria ang isda *kay* *Pedro*.
 APPL-<TR.PFV>give GEN Maria NOM fish to Pedro
 ‘Maria gave the fish to Pedro.’

Another indication of the association between nominative case and C is the fact that the nominative DP can move to [Spec, CP], for instance to form a relative clause, as in (10b). This is accounted for straightforwardly, since the nominative DP undergoes Agree with C to value case. (10c) shows that a non-nominative DP cannot undergo this movement.

- (10) a. babae-ng [_{C/TP} OP b<um>ili __ nang isda]
 woman-LK <INTR.PFV>buy OBL fish
 ‘woman who bought a/the fish’
- b. isda-ng [_{CP} OP [_{TP} b<in>ili ni Maria __]]
 fish-LK <TR.PFV>buy GEN Maria
 ‘fish that Maria bought’
- c. *isda-ng [_{C/TP} OP b<um>ili ang babae __]
 fish-LK <INTR.PFV>buy NOM woman
 ‘fish that the woman bought’

In contrast, non-DP movement is compatible with both divided (11a) and undivided (11b) C and T. This is accounted for since non-DPs do not need case. I assume with Aldridge (2021) that Tagalog has no *wh*-features; the movement shown in (11) is motivated by a focus feature,

⁵ Anagnostopoulou (2003), Sigurðsson and Holmberg (2008), Béjar and Rezac (2003, 2009), Wiltschko (2008), and others have proposed separating person probes from other ϕ -features. Wiltschko (2008), Deal (2015), and others have proposed placing minimally the person probe on C.

so the non-DPs in (11) move to [Spec, CP] to check the focus feature there.⁶

- (11) a. [CP **Saan** [TP b<in>ili ni Maria ang libro]]?
 where <TR.PFV>buy GEN Maria NOM book
 ‘Where did Maria buy the book?’
- b. [C/TP **Saan** [C/T b<um>ili ang babae nang libro]]?
 where <INTR.PFV>buy NOM woman OBL book
 ‘Where did the woman buy the book?’

Standard Indonesian provides additional evidence for the Feature Inheritance approach to the subject/non-subject dichotomy in Austronesian voice marking. It is well known (Musgrave 2001; Saddy 1991; and Soh 1998; and others) that transitive subjects can be extracted in active clauses, when they have nominative case, as in (12b). On the other hand, objects cannot be extracted in active clauses when the verb carries the active voice prefix *meN-*, as in (12c). One way to extract the theme argument is by making it the subject of a passive, as in (12d). Standard Indonesian is thus similar to Tagalog in allowing nominative DPs to undergo A'-movement.

- (12) a. Ali **mem**-beli buku.
 Ali ACT-buy buku
 ‘Ali bought a book.’
- b. Siapa yang **mem**-beli buku-nya?
 who C ACT-give book-DEF
 ‘Who bought the book?’
- c. *Apa yang Ali **mem**-beli?
 what C Ali ACT-buy
 ‘What did Ali buy?’
- d. Apa yang **di**-beli (oleh) Ali?
 what C PASS-buy by Ali
 ‘What was bought by Ali?’

However, objects can be extracted in active clauses if the *meN-* prefix is deleted. The fact that (13a, b) are active is shown by the position of the subject in preverbal position. The subject consequently values nominative case, so object movement in Indonesian is not contingent on valuing this case. These examples are taken from Cole & Hermon (2005: 63-64). In other words, C and T are free to divide⁷ so long as *meN-* does not appear on the verb.

- (13) a. [Orang yang [polisi **tangkap** di pasar]]
 person that police arrest in market
 telah men-curi tas.
 already *meN*-steal purse
 ‘The man that the police arrested in the market had stolen a purse.’

⁶ Evidence for the lack of *wh*-features in Tagalog and other Austronesian languages of Taiwan and the Philippines comes from the following facts: 1) the morphology of interrogative pronouns showing incorporated case markers and adpositions rather than A'-related affixes; 2) the structural asymmetry between movement to [Spec, CP] in the case of non-DPs and clefting in the case of DPs; and 3) the strong connection between nominative case and DP extraction. These facts would not be straightforwardly accounted for if interrogative constituents were uniformly attracted by a *wh*-feature.

⁷ See Park (2022) for a similar analysis employing C and T bundling.

- b. [Buku [yang Budi tidak akan **baca**]] sangat menarik.
 book that Budi not will read very interesting
 ‘The book that Budi will not read is very interesting.’

Sato (2008) proposes that the structural location for the active prefix *meN-* is the lower phase head *v*. He accounts for the possibility of object extraction in cases like (13) post-syntactically, proposing that the *meN-* prefix cannot be spelled out on *v* if a DP has been attracted to the edge of this phase. I propose a slight reworking of this analysis in the Feature Inheritance approach. Movement of the object forces Inheritance to take place in *vP*, since this is required in order to project an escape hatch for the moving object. I tentatively analyze the lower head as an unitalicized *v*. I further propose that the prefix *meN-* cannot be spelled out on *v* that has split with a lower head, i.e. after Inheritance has taken place. From the edge of *vP*, the object will move further to [Spec, CP], while the subject is attracted to [Spec, TP].

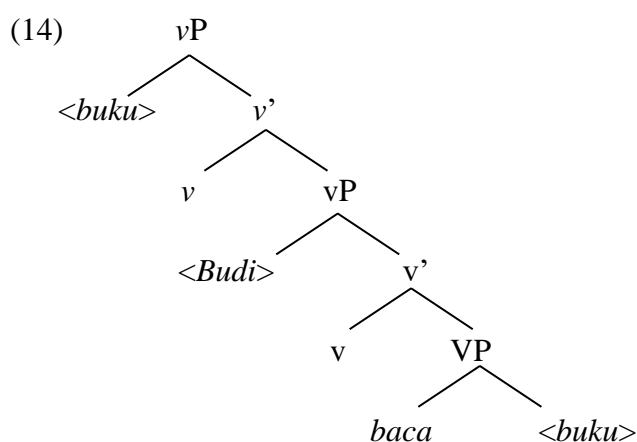

In this section, I presented an analysis of voice, case licensing, and DP dislocation in Tagalog (and also partially for Standard Indonesian) within the framework of C-T Inheritance. Inheritance must take place in order to case license two arguments in ergative clause types in Tagalog, as well as to allow dislocation of a lower argument over the subject in both Tagalog and Indonesian. I further argued that a change in morphological marking in the perfective aspect correlates with whether Inheritance has taken place. This is indicated in Indonesian *vP* by the absence of the *meN-* prefix. The next section provides cross linguistic support for the Inheritance approach to licensing and/or dislocation by showing how C-T Inheritance correlates with certain subject/object asymmetries in languages outside the Austronesian family.

3. Application of the analysis beyond Austronesian

In this section, I show how the C-T Inheritance analysis proposed in the preceding section also accounts for morphological alternations accompanying subject/non-subject asymmetries for licensing and/or dislocation in languages outside the Austronesian family.

3.1 Subject/non-subject complementizer agreement in Wolof

According to Dunnigan (1994), Torrence (2005), Martinović (2015, 2021), and others, Wolof employs different complementizers depending on whether a subject or non-subject constituent moves to [Spec, CP]. The complementizer is *a* in subject extraction, as in (15a) and *la* for non-

subject movement, as in (15b).

- (15) a. K-an **a** jox Musaa téere bi?
 CM-Q C.WH hand Moussa book DEF.SG
 ‘Who handed the book to Moussa?’
- b. K-an **l-a** Musaa gis?
 CM-Q C.WH Moussa see
 ‘Who did Moussa see?’ (Martinović 2015: 207)

Martinović (2015) proposes an analysis of this complementizer asymmetry⁸ in the Pesetsky and Torrego (2001) approach to the relationship between C and T. This approach does not adopt Feature Inheritance but assumes that C and T always host separate projections. However, there is a resemblance between this approach and C-T Inheritance. When A'-extraction of a non-subject constituent takes place, T also moves to C. But T-to-C movement is obviated in subject extraction. T-to-C movement is also obviated on the Inheritance approach I assume, though this is because T and C are part of the same complex head on my approach.

Turning to how the Pesetsky & Torrego (2001) approach to A'-movement accounts for the complementizer alternation in Wolof, Martinović (2015) proposes that *a* and *l* are distinct functional heads. The former is merged in C as the complementizer. This accounts for the appearance of this vowel in both subject and non-subject extraction. If a non-subject is extracted, as in (16b), T-to-C movement also takes place, and *l* is inserted post-syntactically on a T that has moved to C. Consequently, *l-a* will be spelled out on the C+T head in cases of non-subject extraction. Note that the subject moves to [Spec, TP] in both cases.

- (16) a. [_{C/TP} K-an **a** [_{TP} <k-an> [_{VP} <k-an> ...]]]?
 CM-Q C.WH
 ‘Who handed the book to Moussa?’
- b. [_{CP} K-an **l-a** [_{TP} Musaa <T> [_{VP} <Musaa> gis <k-an>]]]?
 CM-Q C.WH Moussa see
 ‘Who did Moussa see?’ (Martinović 2015: 207)

The crux of this analysis can be accommodated within the C-T Inheritance framework with minimal modification. With Martinović (2015), I assume that *a* is merged in C. If a non-subject undergoes movement over the subject, C and T must divide, the subject moving to [Spec, TP] to value case and the lower constituent moving to [Spec, CP]. I propose that *l* is merged on T that has split from C/T. I further follow Martinović (2015) in assuming that T moves to C in non-subject extraction, resulting in the adjacency of *l* and *a*, spelled out as the non-subject extraction complementizer *la*, as in (17a). In cases of subject extraction, the C/T head does not divide, so *l* is not merged, and the complementizer *a* is spelled out on the undivided C/T head, as in (17b).

⁸ A more recent (Martinović 2021) version uses feature splitting. In object *wh*-movement, the [wh] feature and the complementizer *la* split from the bundled CI (C/T) head that has already attracted the subject to its specifier. Feature movement functions as a projecting head, hosting a new specifier position for the object *wh*-constituent.

- (17) a. [CP K-an I-a [TP Musaa <l-> [vP gis ...]]]?
 CM-Q C.WH Moussa see
 ‘Who did Moussa see?’ (based on Martinović 2015: 207)
- b. [C/TP K-an a [vP jox Musaa téere bi]]?
 CM-Q C.WH hand Moussa book DEF.SG
 ‘Who handed the book to Moussa?’

There are only two minor differences between Martinović (2015) and the current approach. First, C-T Inheritance obviates subject movement to [Spec, TP] in subject A'-extraction cases, since C and T do not divide. Secondly, my approach also obviates the extra step of post-syntactic spell out of *l-* as a reflex of T-C movement, since the correct result is obtained in my approach by merging *l-* in T in the Syntactic Component before T-C movement takes place.

3.2 V2 and voice in Dinka

The Nilotic language Dinka has a voice system that is remarkably similar to Tagalog (Anderson 1988, 2015; and van Urk 2015). As in Tagalog, there is a correlation between morphological alternations on the finite verb and which argument appears in clause-initial position with nominative case. Unlike Tagalog, Dinka has V2 word order, a DP typically surfacing in clause-initial position, followed by the finite verb. In the “subject voice”, the subject precedes the finite verb, and the verbal morphology assumes the default form, as shown in (18a). “Object voice”, as in (18b), is associated with a floating low tone, inducing high tone and lengthening of the vowel, as well as raising in some cases. The object moves to clause-initial position. In “oblique voice”, the verb takes “object voice” inflection in addition to a suffix, which van Urk (2015) analyzes as an incorporated preposition. The argument originally selected by the preposition moves to clause-initial position. In the non-subject voices, the subject appears in postverbal position and is marked with genitive case, which is signaled by tone changes on the argument. This is reminiscent of Tagalog. Another similarity is in the double voice marking when an adjunct is extracted, i.e. the combination of object voice and the incorporated preposition. In Tagalog, double marking is manifested by the perfective aspect marker *<in>* together with an applicative affix.

- (18) a. Àyén à-càm cuḷin nè pǎal.
 Ayen 3SG-eat.SV food P knife
 ‘Ayen is eating food with a knife.’
- b. Cuḷin à-céem Áyèn nè pǎal.
 food 3SG-eat.OV Ayen P knife
 ‘Food, Ayen is eating with a knife.’
- c. Pǎal à-céem-è Áyèn cuḷin.
 knife 3SG-eat.OBLV Ayen food
 ‘With a knife, Ayen is eating food.’ (van Urk 2015: 61)

Van Urk (2015) proposes that the clause-initial DP occupies [Spec, CP], which is a case position, so the C head enters the derivation with [$u\bar{A}$] and [$u\varphi$] features. Note that the finite verb also registers agreement with the DP that precedes it. The [$u\bar{A}$] feature on C attracts a topic to clause-initial position where it values absolutive (equivalent to nominative) case and agrees with the verb in C. There is also a [$u\varphi$] feature on T to attract the subject to [Spec, TP].

However, genitive case is not valued in the syntax. Rather, van Urk treats it as a “repair strategy” to license the subject in [Spec, TP] post-syntactically. This allows the subject to be further attracted to [Spec, CP] in subject voice clauses, where it values absolutive/nominative case. In the non-subject voices, the subject remains in [Spec, TP], while a lower argument moves to [Spec, CP]. The finite verb in all clauses moves to C to derive the V2 word order. Van Urk does not provide a specific analysis of the alternation between subject and object voice morphology but merely speculates that the change from default marking in subject voice to the marked variant in the other voices is somehow a reflection of non-subject movement to [Spec, CP], but the details are not spelled out. On the other hand, van Urk does have a specific proposal for the suffix that appears in adjunct extraction, showing that this should be analyzed as a stranded preposition that raises and undergoes incorporation to the finite verb in C.

In contrast to this, the C-T Inheritance approach does offer a straightforward account of the voice alternation in Dinka. I illustrate this for each of the voices in the remainder of this subsection. First, the subject voice is derived if C/T enters the derivation with one set of [$u\phi$] and [u NOM] features. Since this means that only one DP can be licensed outside of ν P, C-T Inheritance does not take place, and the subject moves to [Spec, C/TP] to value the [$u\phi$] and [u NOM] features there. The default marking on the verb in subject voice is the spell out of the undivided C/T head. V2 word order results from verb movement to C/T, as in van Urk (2015). The C-T Inheritance approach, then, obviates the need for subject movement through [Spec, TP], as well as the stipulation that genitive case on postverbal subjects is a repair strategy.

- (19) a. Àyén à-càm cuḡin nè pǎal.
 Ayen 3SG-eat.SV food P knife
 ‘Ayen is eating food with a knife.’ (van Urk 2015: 61)

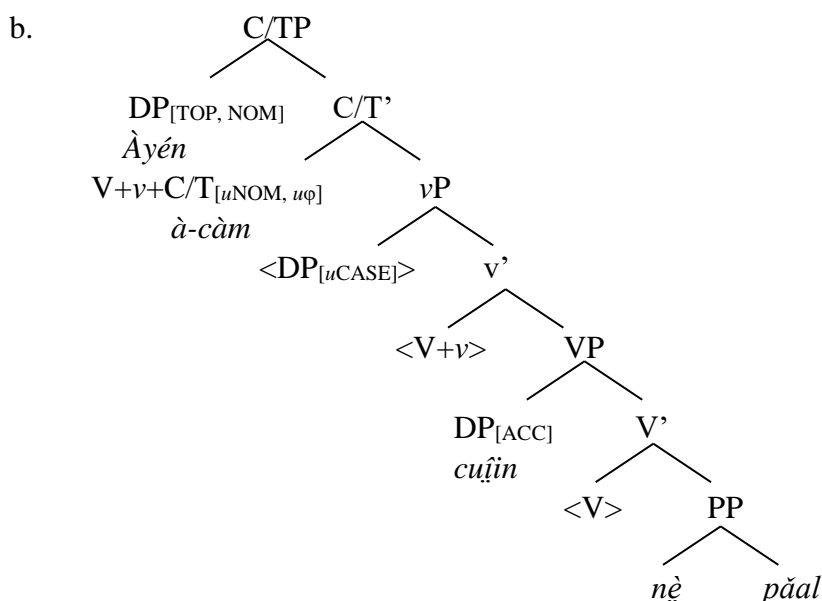

The object voice results when C/T enters the derivation with two sets of DP licensing features: [$u\phi$] + [u GEN] and [$u\phi$] + [u NOM] features. The presence of two licensing features causes C and T to divide, the subject moving to [Spec, TP] to value [$u\phi$] + [u GEN] and the object moving to [Spec, CP] to value [$u\phi$] + [u NOM]. The association of nominative case with C, rather than T, is also in accordance with the analysis of Tagalog, since the clause-initial DP in Dinka is a

topic. Object voice is spelled out when T and C are separate heads. Again, this marks an improvement over van Urk (2015), since it provides an explicit analysis of the alternation between subject and object voice morphology. My approach is also fully in accordance with his intuition that object voice signals movement of a lower argument over the subject. In my approach, this is because movement of the lower argument requires C and T to host separate projections.

- (20) a. *Cuḷin à-céem Áyèn nè pǎal.*
 food 3SG-eat.OV Ayen P knife
 ‘Food, Ayen is eating with a knife.’ (van Urk 2015: 61)

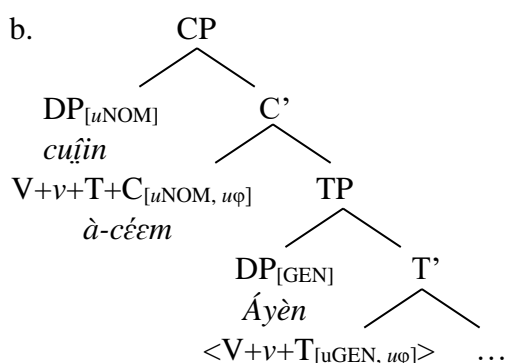

Finally, the analysis of oblique voice is equally straightforward in the C-T Inheritance approach. First, I follow van Urk (2015) in analyzing the oblique voice marker as an incorporated preposition. The additional appearance of object voice on the verb is due to the fact that a lower argument must move over the subject, so C/T must enter the derivation with $[u\phi] + [uGEN]$ and $[u\phi] + [uNOM]$ features. The presence of two sets of licensing features causes C and T to split. The subject moves to [Spec, TP] to value $[u\phi] + [uGEN]$, while the adjunct moves to [Spec, CP] to value $[u\phi] + [uNOM]$. The verb moves to C, and the preposition stranded by adjunct movement raises and adjoins to the finite verb in C. Object voice is spelled out, since T and C are separate heads.

- (21) *Pǎal à-céem-è Áyèn cuḷin.*
 knife 3SG-eat.OBLV Ayen food
 ‘With a knife, Ayen is eating food.’ (van Urk 2015: 61)

To summarize the C-T Inheritance approach to voice in Dinka, subject (default) voice is spelled out on undivided C/T. Object voice is spelled out on C if it has divided from T. Oblique voice combines object voice to allow movement of the lower argument and host incorporation of the preposition stranded by this movement. This analysis allows Dinka voice to be treated in parallel fashion to Tagalog. The alternation between subject and object voice in Dinka is analogous to the alternation between *<um>* and *<in>* in the perfective aspect in Tagalog. Dinka also exhibits double voice marking in adjunct extraction, just as Tagalog. In Dinka, this is seen in the incorporation of the preposition to the object voice verb. Tagalog involves the combination of non-subject perfective aspect marker and an applicative affix.

4. Conclusion

This paper has proposed an analysis of the Tagalog “voice” system within the framework of C-T Inheritance. I showed that the hallmark subject/non-subject asymmetry marked in the perfective aspect can be captured on the basis of whether C-T Inheritance has taken place. The subject voice obtains if Inheritance does not take place, while non-subject voice results when these two heads divide and host their own projections. Whether Inheritance takes place is a consequence of whether C/T must license one or two arguments. There is only one argument licensed by C/T in subject voice clauses, but non-subject voice involves the licensing of both the ergative subject and a nominative/absolute object. Different perfective aspect markers signal whether Inheritance has taken place in Tagalog. I also suggested that English *do*-support can be viewed as an analogous type of marking, occurring only with non-subject A'-movement, i.e. when C and T are divided. I further extended this analysis to the complementizer asymmetry observed in subject versus non-subject A'-movement in Wolof. Finally, I showed that the dichotomy between subject and non-subject voice in Dinka is also completely parallel to Tagalog. This cross linguistic evidence suggests very strongly that C-T Inheritance does not take place automatically but rather must be forced. And when it does take place, the divide between C and T frequently receives overt morphological marking.

References

- Aldridge, Edith. 2017a. Extraction asymmetries in ergative and accusative languages. In *Proceedings of GLOW in Asia XI*, ed. by Michael Yoshitaka Erlewine, 1-20. MIT Working Papers in Linguistics 85. Cambridge, MA: Department of Linguistics, MIT.
- Aldridge, Edith. 2017b. ϕ -feature competition: A unified approach to the Austronesian extraction restriction. In *Proceedings of the 52nd meeting of the Chicago Linguistic Society (CLS) 52*, ed. by Jessica Kantarovich, Tran Truong, and Orest Xherija, 1-20.
- Aldridge, Edith. 2018. C-T Inheritance and the Left Periphery in Old Japanese. *Glossa* 3.1:1-22. DOI: <http://doi.org/10.5334/gjgl.254>
- Aldridge, Edith. 2019. Subject/non-subject movement asymmetries in Late Archaic Chinese. *Glossa* 4.1:1-38. (Article 115.)
- Aldridge, Edith. 2021. The nature and origin of syntactic ergativity in Austronesian languages. In *Syntactic Features and the Limits of Syntactic Change*, ed. by Jóhannes Gísli Jónsson and Thórhallur Eythórsson, 265-300. Oxford: Oxford University Press.
- Anagnostopoulou, Elena. 2003. *The Syntax of ditransitives: Evidence from clitics*. Berlin: Mouton de Gruyter.
- Anderson, Torben. 1988. Ergativity in Pari, a Nilotic OVS language. *Lingua* 75:289-324.
- Anderson, Torben. 2015. Syntacticized topics in Kurmuk: A ternary voice-like system in Nilotic. *Studies in Language* 39.3:508-554.
- Bailyn, John F. 1997. Genitive of negation is obligatory. *Formal Approaches to Slavic Linguistics* 5:84-114.
- Béjar, Susana and Milan Rezac. 2003. Person licensing and the derivation of PCC effects. In *Romance linguistics: Theory and acquisition*, ed. by Ana Teresa Perez-Leroux and Yves Roberge, 49-62. Amsterdam: Benjamins.
- Béjar, Susana and Milan Rezac. 2008. Cyclic agree. *Linguistic Inquiry* 40.1: 35-73.
- Belletti, Adriana. 1988. The case of unaccusatives. *Linguistic Inquiry* 19.1:1-34.
- Bobaljik, Jonathan. 1995. Morphosyntax: The syntax of verbal inflection. Doctoral dissertation, MIT.
- Chen, Victoria. 2017. A Reexamination of the Philippine-type Voice System and its Implications for Austronesian Primary-level Subgrouping. Doctoral dissertation, University of Hawaii.
- Chomsky, Noam. 2008. *On phases*. In *Foundational Issues in Linguistic Theory: Essays in Honor of J-R. Vergnaud*. Cambridge, MA: MIT Press.
- Chung, Sandra. 1994. Wh-Agreement and Referentiality in Chamorro. *Linguistic Inquiry* 25.1:1-44.
- Chung, Sandra. 1998. *The Design of Agreement*. Chicago: University of Chicago Press.
- Cole, Peter, Gabriella Hermon. 2005. Subject and Non-subject Relativization in Indonesian. *Journal of East Asian Linguistics* 14:59-88.
- Deal, Amy Rose. 2015. Interaction and satisfaction in ϕ -agreement. In *NELS 45: Proceedings of the 45th Annual Meeting of the Northeast Linguistic Society*, ed. by Thuy Bui and Deniz Özyildiz, 1-14. Create Space Independent Publishing Platform.
- Diesing, Molly. 1992. *Indefinites*, Linguistic Inquiry Monograph 20, Cambridge, MA: MIT Press.
- Dunigan, Melynda B. 1994. On the clausal structure of Wolof. Doctoral Dissertation, University of North Carolina at Chapel Hill, Chapel Hill, NC.
- Enç, Mürvet. 1991. The semantics of specificity. *Linguistic Inquiry* 22.1:1-25.

- Erlewine, Michael Yoshitaka. 2016. Multiple extraction and voice in Toba Batak. In *The Proceedings of the 23th Meeting of the Austronesian Formal Linguistics Association*, ed. by Hiroki Nomoto, Takuya Miyauchi, and Asako Shiohara, 81-95. Canberra: Asia-Pacific Linguistics.
- Erlewine, Michael Yoshitaka. 2018. Extraction and licensing in Toba Batak. *Language* 93.4:662-697.
- Gallego, Angel J. 2014. Deriving featuring inheritance from the copy theory of movement. *The Linguistic Review* 31.1:41-71.
- Georgopoulos, Carol. 1991. *Syntactic variables*. Dordrecht: Kluwer Academic Publishers.
- Halle, Moris and Alec Marantz. 1993. Distributed Morphology and the pieces of inflection. In *The view from Building 20: Essays in linguistics in honor of Sylvain Bromberger*, ed. by Kenneth Hale & Samuel J. Keyser, 111-176. Cambridge, MA: MIT Press.
- Kornfilt, Jaklin. 1984. Case marking, agreement, and empty categories in Turkish. Doctoral dissertation, Harvard University.
- Lasnik, Howard. 1995. Verbal morphology: Syntactic structures meets the Minimalist Program. In *Revolution and evolution in linguistic theory: Essays in honor of Carlos Otero*, ed. by Héctor Campos and Paula Kempchinsky, 251-275. Washington, D.C.: Georgetown University Press.
- Legate, Julie. 2011. Under-Inheritance. Paper presented at NELS 42, University of Toronto.
- Legate, Julie. 2014. *Voice and v: Lessons from Acehnese*. Cambridge, MA: MIT Press.
- Longobardi, Giuseppe. 2008. Reference to individuals, person, and the variety of mapping parameters. In *Essays on nominal determination: From morphology to discourse management*, ed. by Henrik Høeg Müller and Alex Klinge, 189–211. Amsterdam: John Benjamins.
- Martinović, Martina. 2015. Feature geometry and head-splitting: Evidence from the morphosyntax of the Wolof clausal periphery. Doctoral dissertation, University of Chicago.
- Martinović, Martina. 2021. Feature geometry and head splitting in the Wolof clausal periphery. *Linguistic Inquiry* (early access).
- Musgrave, Simon. 2001. Non-subject arguments in Indonesian. Doctoral dissertation, University of Melbourne.
- Ouali, Hamid. 2006. On C-to-T ϕ -transfer: The nature of agreement and anti-agreement in Berber. In *Agreement restrictions*, ed. by Roberta D'Alessandro, Susann Fischer, and Gunnar Hrafn Hrafnbjargarson, 159-180. Berlin: Mouton de Gruyter.
- Park, Dongwoo. 2022. The existence of a bundled CT head in Bahasa Indonesian. *Linguistic Research* 39.2:297-326.
- Pearson, Matthew. 2001. The clause structure of Malagasy: A Minimalist approach. Doctoral dissertation, UCLA.
- Pesetsky, David. 1982. Paths and categories. Doctoral dissertation, MIT.
- Pesetsky, David, and Esther Torrego. 2001. T-to-C movement: Causes and consequences. In *Ken Hale: A life in language*, ed. by Michael Kenstowicz, 355-426. Cambridge, MA: MIT Press.
- Pylkkanen, Liina. 2002. Introducing arguments. Doctoral dissertation, MIT.
- Rackowski, Andrea. 2002. The structure of Tagalog: Specificity, voice, and the distribution of arguments. Doctoral dissertation, MIT.
- Rackowski, Andrea & Norvin Richards. 2005. Phase edge and extraction: A Tagalog case study. *Linguistic Inquiry* 36.4:565-599.

- Richards, Marc. 2008. Quirky expletives. In *Agreement restrictions*, ed. by Artemis Alexiadou and T. Alan Hall, 181-213. Berlin & New York: Mouton de Gruyter.
- Richards, Norvin. 2000. Another look at Tagalog subjects. In *Formal issues in Austronesian linguistics*, ed. by Ileana Paul, V. Phillips, and Lisa Travis, 105-116. Dordrecht: Kluwer Academic Publishers.
- Saddy, Douglass. 1991. Wh-scope mechanisms in Bahasa Indonesia. In *More papers on wh-movement*, ed. by Lisa Cheng and Hamida Demirdash, 183-218. MIT Working Papers in Linguistics 15. Cambridge, MA: Department of Linguistics, MIT.
- Sato, Yosuke. 2008. Minimalist interfaces: Selected issues in Indonesian and Javanese. Doctoral dissertation, University of Arizona.
- Schachter, Paul. 1976. The Subject in Philippine languages: Topic, actor, actor-topic, or none of the above. In *Subject and topic*, ed. by Charles Li, 91-518. New York: Academic Press.
- Sigurðsson, Halldór and Anders Holmberg. 2008. Icelandic dative intervention: Person and number are separate probes. In *Agreement restrictions*, ed. by Roberta D'Alessandro, Susann Fischer, and Gunnar Hrafn Hrafnbjargarson, 251-279. Berlin: Mouton de Gruyter.
- Soh, Hooi Ling. 1998. Certain restrictions on A-bar movement in Malay. In *Proceedings of the 3rd and 4th Meetings of the Austronesian Formal Linguistics Association (AFLA)*, ed. by Matthew Pearson, 295-307. UCLA Occasional Papers in Linguistics 21. Los Angeles: Department of Linguistics, UCLA.
- Torrence, Harold. 2005. On the distribution of complementizers in Wolof. Doctoral dissertation, University of California, Los Angeles, Los Angeles, CA.
- Vainikka, Anne. 1989. Deriving syntactic representations in Finnish. Doctoral dissertation, University of Massachusetts, Amherst.
- van Urk, Coppe. 2015. A universal syntax for phrasal movement: A case study of Dinka Bor. Doctoral dissertation, MIT.
- Wiltschko, Martina. 2008. Person hierarchy effects with a person-hierarchy. In *Agreement restrictions*, ed. by Roberta D'Alessandro, Susann Fischer, and Gunnar Hrafn Hrafnbjargarson, 281-313. Berlin & New York: Mouton de Gruyter.

Deriving person-based differential argument marking in Ik

Penelope Daniel

University of Connecticut

1. Introduction

Differential argument marking (DAM) is a pattern where case-marking is sensitive to the interpretational properties of arguments. One well-known example of DAM is *differential object marking* (DOM) of the type found in Turkic languages, such as Sakha: objects are accusative when they are specific, but not when they are nonspecific, as shown in (1) (Baker & Vinokurova 2010).

- (1) a. Erel kinige-ni atyylas-ta.
 Erel book-ACC buy-PAST.3sS
 ‘Erel bought the book.’
 b. Erel kinige atyylas-ta.
 Erel book buy-PAST.3sS
 ‘Erel bought a book/books.’
- (Baker & Vinokurova 2010)

This type of DAM has received the most attention in the literature (Bossong 1991, Aissen 2003, Baker & Vinokurova 2010, i.a.), and has sparked numerous debates about the nature of case assignment. Note that in this pattern, it is an interpretational property of the object that determines the case of that object. Interestingly, it is also possible for the argument with the property that determines case-marking to be different from the argument that bears that case-marking. Baker (2015) observes *differential subject marking* (DSM) patterns where an interpretational property of the object determines the case of the subject. In Eastern Ostyak, for example, the subject is ergative when the object is definite (2a), but not when the object is indefinite, as shown in (2b).

- (2) a. Mə-ŋən ləyə əllə juɣ kanɟa aməyalɔɣ.
 We-ERG them large tree beside put.PAST.3pO/1pS
 ‘We put them (pots of berries) beside a big tree.’
 b. Mä t’əkäjəylännä ula mənɣäləm.
 We.DU.NOM younger.sister.COM berry pick.PAST.1pS
 ‘I went to pick berries with my younger sister.’
- (Gulya 1966)

Since this pattern shows that it is possible to have a dissociation between the argument that is differentially case-marked and the argument with the property that determines that marking, the question arises whether the other logically possible mismatch is attested. In other words, is it possible for an interpretational property of the subject to determine the case of the object? This question has not yet been addressed within the generative literature on DAM. In this paper, I show that this type of pattern is indeed attested. In Ik, the case of the object differs according to the person of the subject: the object is accusative when the subject is 3rd person (3a), but nominative when the subject is 1st or 2nd person (3b-3c).

- (3) a. en-es-ufót-a wík-á njíní-k^a.
 see-IRR-AND-a children-NOM we.IC-ACC
 ‘The children will see us (incl).’
 b. en-í-a nk^a wík^a.
 see-1.SG-a I-NOM children-NOM
 ‘I see the children.’
 c. en-es-íd-a bi^a wík^a.
 see-IRR-2.SG-a you-NOM children-NOM
 ‘You (sg.) will see the children.’ (König 2008)

I will show that this pattern is surprising from the perspective of current approaches to DAM, but actually fits naturally in an approach where case is assigned by a functional head (Chomsky 2000; Bošković 2007, 2011). Specifically, I propose that this pattern arises because ν -heads in this language are responsible for both the person of the subject and the case of the object.

In the following section, I will discuss relevant background on the syntax of Ik and elaborate on the DAM pattern in more detail. In section 3, I draw a parallel between Ik DAM and the *Person Case Constraint* (PCC), which I will show to support an analysis where the DAM pattern is the result of case assignment by ν , which I elaborate on in section 4. In section 5, I will show how this analysis is a better fit for this type of DAM pattern than existing approaches to DAM. Section 6 concludes the paper.

2. Ik data

2.1 Background on Ik

Ik is a Kuliak language spoken in northeastern Uganda by 7,500 speakers. Ik is a VSO language, as shown for the verb-initial intransitive sentence in (4a), and the verb-initial transitive sentence in (4b).

- (4) a. atsa ηók^a.
 come:3SG dog:NOM
 ‘The dog comes.’
 b. cεa boroka ηókík^a.
 kill:3SG bushpig:NOM dog:ACC
 ‘The bushpig kills the dog.’ (Schrock 2017)

Ik is also a pro-drop language: there is subject agreement on the verb, and strong pronoun or lexical NP subjects are optional (5-7). The (a) examples show sentences with strong pronoun and lexical NP subjects, while the (b) examples show sentences without them. Note that in either case, subject agreement is present on the verb.

- (5) a. en-í-a nk^a wík^a.
 see-1.SG-a I-NOM children-NOM
 ‘I see the children.’ (König 2008)
 b. ηk-í-á tobɔŋ-a=na.
 eat-1SG-a mush-NOM=this
 ‘I eat this meal mush.’ (Schrock 2017)

- (6) a. en-es-íd-a bi-^a wík-^a
 see-IRR-2.SG-a you-NOM children-NOM
 ‘You (sg.) will see the children.’ (König 2008)
- b. ηék-íd-a tóbɔŋ-a=na.
 eat-2SG-a mush-NOM=this
 ‘You eat this meal mush.’ (Schrock 2017)
- (7) a. cɛa boroka ηókík^a.
 kill:3SG bushpig:NOM dog:ACC
 ‘The bushpig kills the dog.’
- b. ηka tóbɔŋó-á=na.
 eat:3SG mush-ACC=this
 ‘She eats this meal mush’ (Schrock 2017)

2.2 Ik DAM

As noted above, Ik has a unique case pattern where the case of the object is determined by the person of the subject. Specifically, objects are accusative when the subject is 3rd person (3a, repeated below as 8a), but when the subject is 1st or 2nd person, the object is nominative (3b-c, repeated as 8b-8c). Subjects themselves are nominative, regardless of person.

- (8) a. en-es-uqót-a wík-á njíní-k^a.
 see-IRR-AND-a children-NOM we.IC-ACC
 ‘The children will see us (incl).’
- b. en-í-a nk-^a wík-^a.
 see-1.SG-a I-NOM children-NOM
 ‘I see the children.’
- c. en-es-íd-a bi-^a wík-^a.
 see-IRR-2.SG-a you-NOM children-NOM
 ‘You (sg.) will see the children.’ (König 2008)

To show what makes this pattern unique, recall that the most common DAM pattern is one in which the case of a given argument is determined by an interpretational property of that argument. This was demonstrated previously by the Sakha example (1), where the case of the object is determined by the specificity of that object. Similarly, it is also possible for the case of the subject to vary according to a property of that subject: in Kham, transitive subjects are ergative when they are 3rd person, as shown in (9a) but not when they are 1st or 2nd person, as shown in (9b-c) (Coon & Preminger 2012).

- (9) a. no-e nən-lay poh-na-ke-o.
 he-ERG you-OBJ hit-2P-PERF-3A
 ‘He hit you.’
- b. nga: nən-lay nga-poh-ni-ke.
 I you-OBJ 1A-hit-2P-PERF
 ‘I hit you.’
- c. nən nga-lay nə-poh-na-ke.
 you I-OBJ 2A-hit-1P-PERF
 ‘You hit me.’ (Watters 1973, DeLancey 1981)

In Ik, like in Sakha, the object is differentially case-marked; however, like in Kham, it is the person of the subject that is responsible for that case-marking. As previously discussed, while the dissociation between the argument that is case-marked and the argument with the property that determines that case has been attested in languages such as Eastern Ostyak (2), the type of pattern that we see in Ik has not yet been discussed from a generative perspective. In fact, Ik has the exact reverse of the mismatched relationship between the subject and object that has been found in languages like Eastern Ostyak. This pattern is therefore significant because it is both a deviation from the most common type of DAM pattern, as well as the reverse of the previously attested deviations from that pattern. Since current theories of DAM have been guided by patterns like those in Sakha, Kham, and Eastern Ostyak, the Ik pattern is surprising from the perspective of existing approaches to DAM.

There are, broadly speaking, two main kinds of approaches to DAM. One type of approach focuses on the patterns where the argument that determines case-marking is the same argument that receives the case-marking (like Sakha and Kham). Haspelmath (2021), for example, argues that the presence of a more ‘marked’ case, such as accusative or ergative instead of nominative or absolutive, is a direct morphological reflex of the argument having more ‘marked’ semantics. Kalin (2018) argues that arguments with more marked semantics require additional syntactic licensing compared to arguments with less marked semantics, which can be realized as marked case-marking on that argument. In both of these analyses, the differential case-marking is ultimately a reflex, direct or indirect, of the semantic properties of the case-marked argument. Since the case-marking and semantic property therefore coincide on the same argument, this type of approach cannot be extended to patterns like Ik.

Other approaches to DAM assume case is assigned configurationally, e.g. through *Dependent Case* assignment, and that a ‘dependent case’ is assigned when the two arguments are located in the same domain. In the context of DAM, this is often attributed to movement of the object, where only objects with certain semantic properties move to the same domain as the subject, as will be elaborated on further in section 5. This type of approach is therefore compatible with DAM patterns where the object bears the semantic property responsible for case-marking (like Sakha and Eastern Ostyak), but not with patterns where a semantic property of the subject is responsible, like in Ik.

Given that the Ik pattern closely matches the traits that all other DAM patterns share, except for which argument triggers the case-marking and which one receives it, it would be desirable, if such an analysis is possible, to have a unified analysis of DAM that also includes the Ik pattern. I will show that such an analysis is indeed possible in section 4, after briefly comparing Ik DAM to the Person Case Constraint in the following section.

3. Parallelism with the Person Case Constraint

Before accounting for the Ik DAM pattern described above, I will first draw attention to a striking parallelism between the Ik case pattern and another syntactic phenomenon, namely the Person Case Constraint (PCC). The PCC is a phenomenon where some combinations of co-occurring pronouns are restricted according to their person. While different variations or ‘strengths’ of the PCC exist, I focus on a particular version of the PCC that Bonet (1991, 1994) calls the *Weak PCC*, which is a restriction where the direct object (DO) pronoun cannot be 1st or 2nd person when the indirect object (IO) pronoun is 3rd person, as shown in (10) for Catalan. Observe that the 1st person DO and 3rd person IO cannot co-occur (10a), despite the fact that a 3rd person DO may co-occur with a 1st person IO.

- (10) a. *Al director, me li ha recomanat la Mireia.
 to-the director, 1SG 3SG.DAT has recommended the Mireia
 ‘As for the director, Mireia has recommended me to him’ (1st person DO, 3rd person IO)
- b. El director, me l’ ha recomanat la Mireia.
 the director, 1SG 3SG.ACC has recommended the Mireia
 ‘As for the director, Mireia has recommended him to me’ (3rd person DO, 1st person IO)
- (Bonet 1991)

Stegovec (2019) shows that in many languages, this same kind of restriction exists not only between IOs and DOs, which are both internal arguments, but also between external arguments (EAs) and internal arguments (IAs).¹ In other words, the IA cannot be 1st or 2nd person when the EA is 3rd person. Interestingly, while the person of the EA does not restrict the *person* of the IA in Ik, the person of the EA does appear to restrict the *case* of the IA. Specifically, the exact environment where the IA cannot be 1st or 2nd person in the languages that Stegovec discusses is the same environment where the IA must be accusative in Ik.

In Stegovec’s (2019, 2020) analysis of these kinds of PCC effects (which he calls *person restrictions*, a term that I will adopt for the rest of the paper), he argues that both pronouns are in an Agree dependency with the same functional head, which affects the person valuation options for the second pronoun. I argue that a similar analysis can be adopted to explain the DAM pattern in Ik. However, instead of affecting the possible person value the IA may have, I argue that ϕ -Agree between the functional head and the EA affects the IA’s ability to get accusative case from that functional head. This accounts for how the person of the EA affects the case of the IA, as I show in the following section.

4. Analysis

4.1 Background assumptions

The key to accounting for the interaction between the person of the EA and the case of the IA lies in the fact that they are both in a dependency with the same functional head, with the relevant dependency being Agree. I will first elaborate on a number of assumptions that I adopt from Stegovec’s (2019, 2020) analysis of person restrictions regarding the Agree relation between the functional head and the EA. First, Stegovec observes that person restrictions only arise with a subset of *deficient pronouns*, which are prosodically dependent pronominal elements. Stegovec argues that the pronouns involved in person restrictions enter the derivation without a person value, which they must acquire through an Agree dependency with a functional head. In other words, the pronouns involved are *minimal pronouns*, in the sense of Kratzer (2009), who argues that minimal pronouns have unvalued interpretable features. Stegovec therefore proposes that only deficient pronouns may be minimal pronouns. Person restrictions then arise when multiple minimal pronouns compete for valuation of their person value from the same functional head.

A minimal pronoun analysis can be extended to Ik subject agreement markers: recall that Ik is a pro-drop language, so strong pronoun and lexical NP subjects are not obligatory (5-7). I adopt a version of Alexiadou & Anagnostopoulou’s (1998) analysis of pro-drop, where the agreement marker is the actual EA, while the optional independent pronoun or lexical NP

¹ I switch to adopting the terminology EA and IA instead of ‘subject’ and ‘object’ for the rest of the paper, since what is relevant is the particular argument, not the syntactic position or grammatical role of the argument.

associated with it is located in a non-argument position.² Crucially, given the prosodic dependence of the agreement marker EA, and the similarity between the Ik DAM pattern and weak person restrictions, I argue that the EA in Ik is a minimal pronoun, which carries unvalued person features.³

I implement these assumptions about the EA by proposing that the EA is base-generated as head-adjoined to v (rather than being part of T). According to Oda (2022), just as phrasal adjunction can be the result of either movement or base-generation (Chomsky 1995), head-adjunction can be the result of either of these processes as well. Given the deficient pronoun status of the EA, which does not project a full phrase and is realized on the verb, it is natural to analyze it as being base-generated in a head-adjoined position to v . We will see below that this will be important for deriving the unique case pattern in Ik.

As stated above, minimal pronouns must undergo ϕ -agreement with a functional head that carries valued person features in order to receive a person value. v -heads have been argued to sometimes host valued ϕ -features like person features in some languages (Kratzer 2009; Legate 2014; Stegovec 2019, 2020). I therefore argue that in Ik, minimal pronoun EAs undergo agreement with v in order to receive a value for person. v -heads vary in the exact value of their person feature, which results in EAs with different person values. For example, if a minimal pronoun EA agrees with a v -head with person features valued as 1st person, the EA will receive a 1st person value, while if the EA agrees with a v -head with person features valued as 2nd person, it will receive a 2nd person value. I also assume that v -heads can lack person features altogether, and I argue that this is the case when the EA is 3rd person. Specifically, I assume that 3rd person is the lack of a person feature (see e.g. Kayne 2000), so when a minimal pronoun EA probes a v -head without a person feature, the EA will be unable to successfully value its person feature, and will receive 3rd person by default (Stegovec 2019, 2020).

4.2 Deriving Ik DAM

I have proposed that the Ik DAM pattern is a result of the valuation of the EA's person features affecting the ability of the IA to receive case. With the above assumptions in place, I will now show how person feature valuation of the EA interacts with case assignment to the IA.

It is traditionally assumed that v is the locus of the feature responsible for accusative case (Chomsky 1995, 2000, 2001; Kratzer 1996). Following Bošković (2011), I assume that this feature on v is a valued case feature ($[\text{val uK}]$), while all arguments carry unvalued case features ($[__ \text{uK}]$). Unvalued features function as probes, which must c-command their goal. As a result, arguments receive accusative case when they are located in a position from which they c-command v , allowing them to undergo case-agreement with v and successfully value their case feature. Within a standard NOM-ACC system, an IA enters the derivation with an unvalued case feature (11a), which causes it to raise to Spec, v P where it successfully agrees with the valued case feature on v and receives accusative case (11b).

(11) a. $[_{vP} v_{[\text{val uK}]} [_{VP} V \text{ IA}_{[__ \text{uK}]}]]$

b. $[_{vP} \text{ IA}_{[\text{val uK}]} [_{vP} v_{[\text{val uK}]} [_{VP} V \text{ } t]]]$

² This is essentially a pronominal argument analysis in the sense of Jelinek (1984, 2006), who proposes that agreement markers *are* the pronominal arguments, or Baker (1988, 1996), who argues that agreement markers license null *pro* in argument positions, but crucially that lexical NPs are located in non-argument positions. In fact, Baker (2003) specifically discusses a number of Bantu languages, which are also *pro*-drop, where only the EA behaves as a pronominal argument, which is what I argue for Ik.

³ Other ϕ -features, when present on the EA, would be valued features (see Stegovec 2019, 2020), and would not require valuation.

We have seen that Ik differs from a standard NOM-ACC system in that the case of the IA is sensitive to the person of the EA. I argue that the reason that the IA does not receive accusative case when the EA is 1st or 2nd person lies in the fact that both arguments require valuation from features on v . Specifically, I propose that the successful valuation of the minimal pronoun EA's person features on v causes all of v 's features to be deleted. This includes not only the person feature, but also the case feature, the deletion of which prevents the IA from receiving accusative case. However, when the EA does not successfully value its person features on v , as is the case for 3rd person EAs, the case feature on v is not deleted, and the IA is able to receive accusative case.

To demonstrate, when the EA probes v , the value it receives for its unvalued person feature ($[_i\pi]$) will depend on the person feature on the v -head. If v has valued person features ($[\text{val } u\pi]$), either 1st or 2nd person, the EA will be able to value its own person features as 1st or 2nd person (12). Following this successful valuation, the person and case features on v will immediately be deleted (13). This means that when it is the IA's turn to probe, there are no features on v since they will have already been deleted. The IA is not a minimal pronoun, so its person features are already valued. However, the IA does have an unvalued case feature. As a result of the deletion of the features on v , the IA will be unable to value its case feature on v , and therefore will not receive accusative case, instead receiving nominative case as a default value.⁴

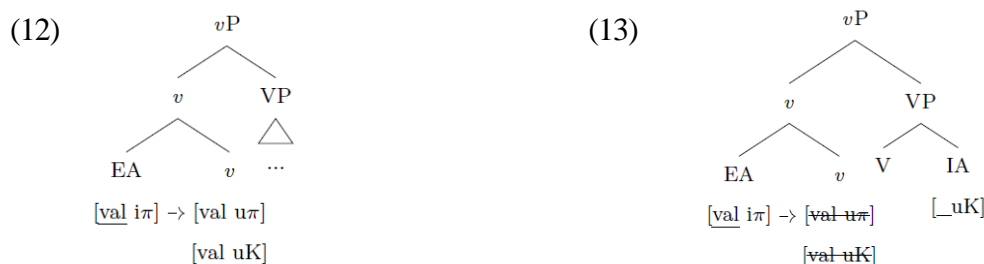

However, recall that if v does *not* have person features, the EA cannot value its person features on v , so it instead receives a default 3rd person value. Since no successful valuation has taken place, the features on v , which includes the valued case feature, are not deleted. As a result, the case feature on v is still available for the IA to value its own case feature and receive accusative case (14).⁵

⁴ As the default case, nominative would be expected to appear on NPs used in ‘out of the blue’ contexts. In English, the default case is accusative, as shown in sentences like “Me, intelligent?”. Further research is needed to test these predictions in Ik: the only examples of similar contexts that I have identified involve the use of a ‘copulative’ case – it is unclear whether NPs can appear outside of this copulative construction, and if so, what case they would appear in. Importantly, there is no evidence that accusative case is used in these contexts.

⁵ Note that this is not the final word order. We have seen that Ik is a VSO language, which I assume is the result of V-to-T movement (see section 5). The adjoined minimal pronoun EA will raise with the verb, while the independent pronoun or lexical NP associated with the EA will be introduced in a non-argument position between T and v (Alexiadou & Anagnostopoulou 1998), such as one of the middle field A'-positions proposed by authors like Belletti (2004).

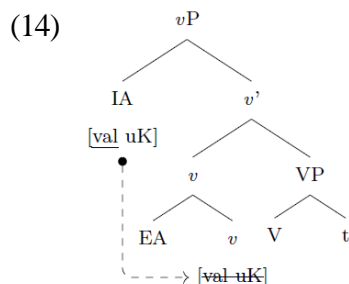

Note that the order of operations is crucial: since the person of the EA determines the case of the IA, it is clear that the dependency between the EA and v must be established before the dependency between the IA and v . Recall that I propose that the EA is base-generated as head-adjoined to v . I argue that this makes it possible for the EA and v to enter the derivation simultaneously. As a result of the EA and v being base-generated and entering the derivation together, the EA is able to immediately probe v . Crucially, this happens before v can establish any dependency with the IA lower in the structure.⁶

It is also crucial that the ϕ - and case features on v are deleted at the same time, as a result of the successful Agree operation. Note that in Bošković's (2011) system, the valuation of case is independent from the valuation of ϕ -features. However, given the interaction between ϕ -features and case in Ik, I argue that it must be possible for ϕ -feature valuation to have an effect on the case features of v in some instances. I propose that this is crucially only possible when the different features on the functional head are both valued uninterpretable features, which is not a possibility considered by Bošković (2011). According to Bošković (2011), contra Chomsky (2000), valuation and interpretability are independent from one another: it is possible for a single feature to be both valued and uninterpretable, or both unvalued and interpretable. Uninterpretable features must be deleted prior to Spell-Out, since they cannot be interpreted at LF. The case and person features on v are both uninterpretable, since they do not affect the interpretation of the verb. Since they are also valued features, this means they may both be deleted. Furthermore, since they are located on the same head, there is nothing to separate them, and therefore nothing to prevent them from being deleted simultaneously: if one is deleted, the other is deleted too.

Finally, note that while the EA receives a value for person, it does not receive a value for case. Observe that none of the minimal pronoun EAs inflect for case in Ik: the subject marker on the verb is same regardless of whether the lexical NP EA is nominative or accusative. We can see this clearly in relative clauses, for example, where the lexical NP EA can exceptionally receive accusative case (15b), but the form of the subject marker is the same as when the lexical NP EA is nominative (15a).

- (15) a. en-í-a nk^{-a} wík^{-a}.
 see-1.SG-a I-NOM children-NOM
 'I see the children.'

⁶ Another possible reason for this order of operations could be that the EA probes first due to its θ -relation to v . Stegovec (2019) argues that v cannot participate in agreement until its θ -role is assigned. As a result, the IA will not be able to undergo case-agreement with v until the EA is introduced and receives a θ -role from v . However, when the EA is introduced, it may immediately probe v and value its person feature. Only after that may the IA agree with v . This is compatible with the current analysis, where the EA is head-adjoined to v , or an analysis where the EA is introduced in Spec, v P.

| | | | | | | | |
|-----------------------------------------------|--------|-------|----------------|---------|---------------------|----------|--------------|
| b. cek-a | ná | ncí-a | en-ufót-í-á | ntsí | wice-k ^a | bíra-a | néé |
| woman-NOM | REL.SG | I-ACC | see-AND-1.SG-a | she.OBL | children-ACC | be.not-a | here.DAT |
| na. | | | | | | | |
| DEM | | | | | | | |
| ‘The woman whose children I saw is not here.’ | | | | | | | (König 2008) |

The most straightforward way to account for this case-invariance is by saying that the minimal pronoun EA actually lacks a case feature altogether. This is consistent with the observation that incorporated nouns do not require case (Baker 1988). Since that the minimal pronoun EA in Ik is prosodically part of the verb, and I analyze it as head-adjoined to v , as discussed in section 4.1, it is natural to analyze its lack of case as a direct consequence of it being incorporated into the verb.

4.3 Interim summary

The proposed analysis correctly predicts when the IA will be able to receive accusative case. Because of the minimal pronoun status of the EA, and the bundling of the valued case and person features on v , the person of the EA will determine the case of the IA: when the EA successfully values its person feature on v , the EA will be valued as 1st or 2nd person, and delete all of the features on v , preventing the IA from valuing its case feature as accusative so that it receives nominative case by default instead. However, when the EA does *not* successfully value its person feature on v , the EA will be valued as 3rd person by default, and will not delete the case feature on v , so the IA may value its case feature and receive accusative case. As a result, the IA will only be able to receive accusative case when the EA is 3rd person, but not when the EA is 1st or 2nd person.

While the focus of this paper is on deriving the particular DAM pattern found in Ik, crucially the proposed analysis can fit within a unified analysis of other, more traditional DAM patterns where the case of an argument is determined by a semantic property of that argument. Since DAM is always driven by an interpretational property of an argument, I assume that DAM is always driven by an argument with an unvalued interpretable feature receiving a value from a functional head. Abstractly speaking, in the traditional DAM patterns just described, an argument will receive case according to whether it undergoes valuation for an interpretable feature. In Sakha, for example, the IA will receive accusative case when it values its interpretable feature corresponding with specificity. In Kham, on the other hand, the EA will receive ergative case only when it does not successfully value its interpretable person feature and receives 3rd person by default. Mismatches, like in Ik and Eastern Ostyak, arise when the valuation of an argument’s interpretable feature affects the availability of the case feature for another argument.⁷ The current proposal therefore demonstrates that analyzing the Ik case pattern within the phenomenon of DAM is possible.

5. Advantages over current approaches to DAM

I have proposed an analysis of Ik DAM where the IA receives accusative case via agreement with a v -head. There have also been numerous recent proposals to account for DAM phenomena. As previously discussed, several approaches to DAM suggest that the case-marking is reflex of the markedness of a semantic property of the argument it is realized on (Kalin 2018, Haspelmath 2021). As a result, these analyses are focused on patterns in which

⁷ While the details of the other DAM patterns are outside the scope of this paper, Daniel (in prep.) develops a unified analysis of all of the DAM patterns.

the argument with the semantic property that determines case-marking is the same as the argument that is case-marked, and have nothing to say about DAM patterns like those in Ik, where the two are independent.

There have also been attempts to account for DAM within the Dependent Case framework, which I will discuss in more detail here. In this framework, ‘dependent case’ is assigned when one non-case-marked argument c-commands another within the relevant domain (Marantz 1991, Baker & Vinokurova 2010, Baker 2015). These arguments are considered to be ‘case competitors,’ with only one of them receiving the dependent case. In a NOM-ACC system, this case will be accusative, assigned to the lower of the two arguments. Baker & Vinokurova (2010) propose a Dependent Case analysis for Sakha DAM, where specific IAs are accusative, and non-specific IAs are nominative, as shown previously in (1). They argue that only specific IAs undergo raising into the same domain as the EA, which triggers the assignment of accusative, as shown in (16a), where the bolded VP indicates the boundary between the two case domains. Non-specific IAs do not raise, so they are not in the same domain as the EA and do not receive accusative case (16b). Baker (2015) argues that the relevant domain is the phase (Chomsky 2000, 2001), which in this case would be VP, indicated in bold in (16).

- (16) a. [_{VP} Erel [_{VP} book-ACC [_{VP} *t* buy]]]
 b. [_{VP} Erel [_{VP} book buy]] (Baker & Vinokurova 2010)

Note that in this approach, a semantic property of the IA is responsible for its movement into the same phase as the EA when accusative case is assigned. In Ik, however, the case-marking is not determined by a semantic property of the IA: it is a semantic property of the EA (person) that determines whether the IA is accusative. A Dependent Case analysis would need to explain why the IA would be in the same phase as the EA when the EA is 3rd person, but not when the EA is 1st or 2nd person.

One option for such an explanation would be that the size of the phase varies so that it includes both the EA and IA when the EA is 3rd person, but separates the EA from the IA when it is 1st or 2nd person. This option is represented in (17), where *v* is the new boundary, indicated in bold.⁸ Another option would be that EAs begin in the same phase as IAs, but 1st and 2nd person EAs raise out of that phase, while 3rd person EAs remain there, as shown in (18).

- (17) a. DAM: [_{VP} EA [_{VP} *v* [_{VP} IA-ACC]]]
 b. No DAM: [_{VP} EA [_{VP} *v* [_{VP} IA]]]

- (18) a. DAM: [_{XP} [_{VP} EA IA-ACC]]
 b. No DAM: [_{XP} EA [_{VP} *t* IA]]

However, there is evidence against both of these options for Ik. Regarding the first option, recall that Ik is a VSO language. I propose, on the basis of the verb combining with TAM

⁸ Coon & Preminger (2017) propose an analysis like this for *ergative splits*, that is, instances where ergative alignment is lost in some contexts, such as in certain aspects or with arguments of a certain person. They adopt a Dependent Case approach, which treats ergative case as a dependent case that is assigned to the higher of two arguments in the same phase (rather than the lower argument, as we saw for accusative case in NOM-ACC systems). They argue that in the contexts where ergative alignment appears to be lost, there isn’t actually a change in alignment, but instead that there is an additional phase boundary, which separates the two arguments, preventing ergative from being assigned.

morphology, and appearing to the right of overt complementizers, that this order is a result of V-to-T movement. Fenger (2020) observes, based on a large-scale typological study, that this type of movement always extends the phase, and thus the Spell-Out domain (cf. phase extension or phase sliding; Dikken 2007, Gallego & Uriagereka 2007). Given this robust cross-linguistic generalization, and the lack of any evidence for a difference in phase size, it is natural to assume that the EA and IA are always in the same phase, regardless of the person of the EA.

The second option predicts that any movement of the EA, including A'-movement, should bleed assignment of accusative, since it removes it from the phase that the IA is in. This is because in the Dependent Case framework, it matters only whether two arguments are in the same phase, regardless of how they reached the positions they are in. However, in subject questions, wh-movement of the EA does not disrupt the case pattern: even with the phase being extended to TP, the EA raises out of it, since it targets Spec,CP.⁹ In the subject question in (19), for example, the IA is still accusative, and there is no independent evidence that 1st or 2nd person EAs are higher than 3rd person EAs in Ik.

- (19) ndoo óá j́cìk^{a?}
 who:COP call:3SG:REAL I:ACC
 'Who calls me?' (Schrock 2017)

Since wh-movement is not normally expected to affect the case pattern, some authors assume that dependent case is assigned as soon as the relevant configuration arises, so that further movement of the arguments does not affect their case-marking (Coon & Preminger, 2017). However, this assumption would also be problematic for Ik, since Ik is actually a rare instance of a language where certain kinds of A'-movement actually do affect the case pattern. For example, when the IA is topicalized, both the EA and IA are nominative, even when the EA is 3rd person (20).¹⁰

- (20) wík-a ñc-i en-a ná ñts-^a.
 children-NOM I-GEN see-a ENC he-NOM
 'As for my children, he sees (them).' (König 2008)

While this provides a challenge for a Dependent Case approach, it can easily be accounted for

⁹ Note that T-to-C movement of the verb, which I have argued undergoes V-to-T movement, does *not* further extend the phase (Gallego 2010). While there is no evidence for or against T-to-C movement in Ik questions, crucially, this means that the wh-moved EA would be located outside of the phase whether this movement occurs or not. Also note that the full pronoun/lexical NP is considered to be the potential case competitor of the IA, since it is eligible for case, while the minimal pronoun EA is not, as discussed in section 4.2. If the minimal pronoun EA is considered to be the case competitor instead, however, it *would* remain in the same domain as IA in subject questions, but see below for additional arguments against a Dependent Case approach.

¹⁰ To show that topicalization in Ik is the result of A'-movement, rather than base-generation, note that Ik topicalization patterns with A'-movement in Bantu languages that have asymmetric double object constructions (Bresnan & Moshi 1990). In these languages, the DO, but not the IO, may be A'-moved in passivization (Holmberg et al. 2019). Similarly, in Ik, only the DO may be topicalized (20), but not the IO (i).

- (i) *ńka-a m-át-a na tɔ̀bɔ̀ŋw-á.
 I-NOM give-3.PL-a ENC food-ACC
 Intended: 'To me they gave food.' (König 2008)

While these are different movement operations, the fact that topicalization in Ik is subject to the same restriction as another movement operation in other languages suggests that it is also the result of movement, since a base-generated topic would not be expected to face this kind of restriction.

in the current analysis. I propose that when the IA undergoes movement for topicalization, it does not pass through any position from which it can value its case feature on v and receive accusative case. This is possible due to the fact that movement targets phasal edges (Chomsky 2000), and does not need to pass through intermediate case-licensing positions (Bošković 2007, Jenkins 2022). In other words, an A'-moving element may pass through the phase edge, without passing through the case position it would normally land in (in this case, Spec, v P). This nicely fits with my proposal that Ik has V-to-T movement that extends the phase: the phase edge that the topic passes through would be Spec,TP. Since the IA's movement is driven by a topic feature, the IA will receive nominative as a default case after skipping the case position in Spec, v P (21). From there, the IA will undergo movement to its final landing site in Spec,CP (or a dedicated topic position in the left periphery of the clause; see Rizzi 1997).

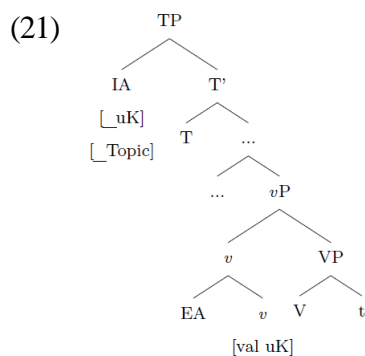

To summarize, it is unclear how a Dependent Case approach would capture the Ik DAM pattern, since there is nothing to motivate the placement of the IA and EA in the same phase when the EA is 3rd person, and in separate domains when the EA is 1st or 2nd person, and there is reason to believe that the IA and EA may be in the same phase even when the IA is not accusative. One final option for a potential Dependent Case analysis is that the dependent case algorithm is somehow sensitive to the person of the EA, with EAs only being considered as case competitors when they are 3rd person. However, in order to account for other varieties of DAM where other interpretational properties are involved, this kind of approach would amount to listing which arguments, depending on their semantic properties, do and do not count as case competitors, which becomes a mere restatement of the facts. The current analysis, on the other hand, uses independently motivated functions of v , valuation of person and case, to capture the interaction between the case of the IA and the person of the EA.

6. Conclusion

I have presented a previously undiscussed case pattern which shows that DAM extends beyond more familiar patterns where a property of some argument (often the IA) affects the case-marking of that argument: in Ik, person features of the EA affect the case marking of the IA. I argue that this typologically rare case pattern can be captured by making use of independently motivated properties of v , namely the valuation of person features of minimal pronouns, and the valuation of accusative case. The interaction between the person of the EA and the case of the IA is therefore the result of a shared dependency with the same functional head. The reason for this dual dependency in particular is the special status of the EA as a minimal pronoun: a deficient pronoun lacking a person value. It is only through the combination of this property of the EA and the presence of both case and person features on v that this Ik pattern arises.

I have also shown that the proposed approach to case assignment is better equipped to handle the Ik data than a Dependent Case approach because it does not rely on the EA and IA being located in separate phases based on their person value. Given that it would be attractive to have a unified analysis of all DAM patterns and basic case patterns, the Ik DAM pattern is problematic for Dependent Case theory more generally. However, I show that an approach to case assignment where accusative case is assigned by agreement with v , like the one proposed here, can account for the data from Ik.

One question that remains to be answered is how the full pronoun or lexical NP associated with the minimal pronoun EA receives case. Recall that I assume that the full pronoun/lexical NP is introduced in a non-argument position between T and Spec, v P. While I do not commit to the precise location of this position, crucially, it is high enough that the full pronoun/lexical NP will not be introduced until after the case feature on v has been deleted, either because the minimal pronoun EA has undergone successful valuation with it in order to receive a person value, or because the IA has raised to Spec, v P and successfully valued its case feature on v . The full pronoun/lexical NP then receives nominative case as a default value. Further investigation into the relationship between the minimal pronoun and full pronoun/lexical NP is required, but this work bears on the discussion of the relationship between agreement marker arguments and their full pronoun/lexical NP counterparts cross-linguistically, since it has been observed that in some languages the agreement marker and full pronoun/lexical NP match in their case-marking, while in other languages they do not (see e.g. Baker & Bobaljik 2017).

Another open question is why this DAM pattern is so rare. While this question is outside of the scope of this paper, the answer may lie in the fact that both the EA and IA require valuation of different features from the same head in Ik. I suggest that the reason this case pattern is not found elsewhere is because this type of competition does not arise in other languages, either because of the status of the EA, the IA, or the structure of the verbal domain. For example, if the EA is not a minimal pronoun, it will not need to undergo agreement with v in order to value its person features, and therefore will not need to compete with the IA for valuation from the same head. Alternatively, if the EA *is* a minimal pronoun, but the IA is too, then the IA will need to undergo valuation for person, but not case, resulting in a person restriction, rather than DAM (see Stegovec 2019, 2020). Finally, if a language has separate heads for the assignment of accusative case and the valuation of the EA's person features, then both the EA and IA will be able to value their respective unvalued features. While the implications of these possibilities remain to be explored, the prediction made by the current proposal is that the type of DAM found in Ik should be limited to languages only where the person of the EA and the case of the IA need to be valued on the same head.

References

- Aissen, Judith. 2003. Differential object marking: Iconicity vs. economy. *Natural Language & Linguistic Theory* 21:435–483.
- Alexiadou, Artemis, and Elena Anagnostopoulou. 1998. Parametrizing AGR: Word order, V-movement and EPP checking. *Natural Language & Linguistic Theory* 16:491–539.
- Baker, Mark C. 1988. *Incorporation: A theory of grammatical function changing*. University of Chicago Press.
- Baker, Mark C. 1996. *The Polysynthesis Parameter*. Oxford University Press.
- Baker, Mark C. 2003. Agreement, dislocation, and partial configurationality. In *Formal Approaches to Function in Grammar: In honor of Eloise Jelinek*, ed. by A. Carnie, H. Harley, and M. A. Willie, 107–132. Amsterdam & Philadelphia: John Benjamins.
- Baker, Mark C. 2015. *Case: Its principles and its parameters*. Cambridge University Press.
- Baker, Mark C., and Jonathan Bobaljik. 2017. On inherent and dependent theories of ergative case. In *The Oxford handbook of ergativity*, ed. by Jessica Coon, Diane Massam, and Lisa Travis. Oxford University Press.
- Baker, Mark C., and Nadya Vinokurova. 2010. Two modalities of case assignment: Case in Sakha. *Natural Language & Linguistic Theory* 28:593–642.
- Belletti, Adriana. 2004. Aspects of the low IP area. In *The structure of CP and IP*, ed. by Luigi Rizzi, 16–51. Oxford University Press.
- Bonet, Eulalia. 1991. Morphology after syntax—pronominal clitics in romance. Doctoral dissertation, MIT.
- Bonet, Eulalia. 1994. The person-case constraint: A morphological approach. *MIT working papers in linguistics* 22:33–52.
- Bošković, Željko. 2007. On the locality and motivation of Move and Agree: An even more minimal theory. *Linguistic Inquiry* 38:589–644.
- Bošković, Željko. 2011. On unvalued uninterpretable features. In *Proceedings of the North East Linguistics Society Annual Meeting*.
- Bossong, Georg. 1991. Differential object marking in Romance and beyond. In *New Analyses in Romance Linguistics*, ed. by Dieter Wanner and Douglas A. Kibbee, 143–170. Amsterdam: John Benjamins.
- Bresnan, Joan, and Lioba Moshi. 1990. Object asymmetries in comparative Bantu syntax. *Linguistic Inquiry* 21(2):147–185.
- Chomsky, Noam. 1995. *The minimalist program*. Cambridge, MA: MIT Press.
- Chomsky, Noam. 2000. Minimalist inquiries: The framework. In *Step by step*, ed. by Roger Martin, David Michaels, and Juan Uriagereka, 89–155. Cambridge, MA: MIT Press.
- Chomsky, Noam. 2001. Derivation by phase. In *Ken Hale: A life in language*, ed. by Michael Kenstowicz, 1–52. Cambridge, MA: MIT Press.
- Coon, Jessica and Omer Preminger. 2012. Towards a unified account of person splits. In *Proceedings of the 29th West Coast Conference on Formal Linguistics*, ed. Jaehoon Choi et al., 310–318.
- Coon, Jessica, and Omer Preminger. 2017. Split ergativity is not about ergativity. In *The Oxford handbook of ergativity*, ed. by Jessica Coon, Diane Massam, and Lisa Travis. Oxford University Press.
- Daniel, Penelope. In prep. A unified analysis of differential argument marking. Ms., University of Connecticut.
- DeLancey, Scott. 1981. An interpretation of split ergativity and related patterns. *Language*

- 57:626–657.
- Dikken, Marcel den. 2007. Phase extension: Contours of a theory of the role of head movement in phrasal extraction. *Theoretical linguistics* 33:1–41.
- Fenger, Paula. 2020. Words within words: The internal syntax of verbs. Doctoral dissertation, University of Connecticut.
- Gallego, Ángel J. 2010. *Phase Theory*. Amsterdam: John Benjamins.
- Gallego, Ángel J., and Juan Uriagereka. 2007. Sub-extraction from subjects: A phase theory account. In *Romance Linguistics 2006*, ed. by José Camacho, Nydia Flores-Ferrán, Liliana Sánchez, Viviane Déprez and María José Cabrera, 149–162. Amsterdam: John Benjamins.
- Gulya, János. 1966. *Eastern Ostyak Chrestomathy*. Bloomington: Indiana University Press.
- Haspelmath, Martin. 2021. Role-reference associations and the explanation of argument coding splits. *Linguistics* 59:123–174.
- Holmberg, Anders, Michelle Sheehan, and Jenneke van der Wal. 2019. Movement from the double object construction is not fully symmetrical. *Linguistic Inquiry* 50:677–722.
- Jelinek, Eloise. 1984. Empty categories, case, and configurationality. *Natural Language & Linguistic Theory* 2(1), 39–76.
- Jelinek, Eloise. 2006. The pronominal argument parameter. In *Arguments and Agreement*, ed. by P. Ackema, P. Brandt, M. Schoorlemmer, and F. Weerman, 261–288. Oxford University Press.
- Jenkins, Robin. 2022. Scrambling and successive movement in Turkish and Uyghur. In *Proceedings of the Chicago Linguistic Society* 57.
- Kalin, Laura. 2018. Licensing and differential object marking: The view from Neo-Aramaic. *Syntax*, 21(2):112–159.
- Kayne, Richard. 2000. *Parameters and Universals*. New York: Oxford University Press.
- König, Christa. 2008. *Case in Africa*. Oxford University Press.
- Kratzer, Angelika. 1996. Severing the external argument from its verb. In *Phrase structure and the lexicon*, ed. by Rooryck, J. and Zaring, L., 109–137. Dordrecht: Springer.
- Kratzer, Angelika. 2009. Making a pronoun: Fake indexicals as windows into the properties of pronouns. *Linguistic Inquiry* 40:187–237.
- Marantz, Alec. 1991. Case and licensing. In *Proceedings of the Eastern States Conference on Linguistics (ESCOL) 1991*, ed. by German Westphal, Benjamin Ao, and Hee-Rahk Chae, 234–253. Ithaca, NY: Cornell University, CLC Publications.
- Oda, Hiromune. 2022. The NP/DP-language distinction as a scale and parameters in minimalism. Doctoral dissertation, University of Connecticut.
- Rizzi, Luigi. 1997. The fine structure of the left periphery. In *Elements of Grammar*, ed. by Liliane Haegeman, 281–337. Dordrecht: Springer.
- Schrock, Terrill B. 2017. *The Ik language: Dictionary and grammar sketch*. Berlin: Language Science Press.
- Stegovec, Adrian. 2019. Person on the edge: Lessons from crosslinguistic variation in syntactic person restrictions. Doctoral dissertation, University of Connecticut.
- Stegovec, Adrian. 2020. Taking case out of the person-case constraint. *Natural Language & Linguistic Theory* 38:261–311.
- Watters, David. 1973. Clause patterns in Kham. In *Clause, sentence and discourse patterns in selected languages of Nepal*, ed. by Austin Hale, 39–202. SIL.

Auto-classifiers in Thai: a post-syntactic reduplication account*

Éva Dékány

Hungarian Research Centre for Linguistics and Eötvös University

1. Introduction

This study inquires into the structure of NPs with auto-classifiers (also known as repeater classifiers, echo classifiers or self-classifiers). Numeral classifiers often develop from common nouns, and may remain form-identical with the source noun. Auto-classifiers are a subtype of numeral classifiers; their definitional property is that they only occur with the form-identical source noun (as well as compounds headed by this noun). Consider the following minimal pair from Thai, a language with N-Num-Cl word order in the NP.

(1) *khon/dek/nákrian* *săam* *khon*
 person/child/student three CLF.person
 ‘three people/children students’ (Pornsiri Singhapreecha, p.c.)

(2) *heetpon* *laay* *heetpon*
 reason several CLF.reason
 ‘several reasons’ (Piriyawiboon 2010: 83)

(1) features the classifier *khon*_{CL}, which is form-identical with and can co-occur with its source noun *khon*_N ‘person’. In addition, *khon*_{CL} can also classify a wide range of human-denoting nouns, including ‘child’ and ‘student’. *Khon*_{CL} is therefore an ordinary, generalized classifier. The classifier of (2), *heetpon*_{CL}, on the other hand, only occurs with the form-identical noun *heetpon*_N ‘reason’ (and, potentially, with compounds headed by this noun). This makes *heetpon*_{CL} an auto-classifier.

Auto-classifiers are common in East and Southeast Asian numeral classifier languages (Aikhenvald 2000; Jones 1970). This paper focuses on data from Thai (but reference will be made to other auto-classifier languages at the appropriate points). According to Hundius & Kölver (1983), Thai has about five hundred auto-classifiers, which leads Jenks (2011: 94) to conclude that auto-classifiers require a grammatical rather than a lexical account. That is, an approach whereby five hundred classifiers accidentally occur only with the form-identical noun (and its compounds) is unsatisfactory; instead, in NPs with auto-classifiers a grammatical link should be made between the exponence of the Cl node and the lexical entry of the noun. Agreeing with Jenks on this point, in this paper I address the nature of this link.

The discussion will proceed as follows. In Section 2 I will give critical discussion of the analysis of auto-classifiers in terms of syntactic head movement (Simpson 2005; Simpson and Ngo 2018), and argue against adopting a movement-based link between auto-classified

* Work on this paper was supported by the János Bolyai Research Scholarship of the Hungarian Academy of Sciences, the ÚNKP-22-5 New National Excellence Program of the Ministry for Innovation and Technology from the source of the National Research, Development, and Innovation Fund and grant NKFIH KKP 129921. I would like to express my warm gratitude to Pornsiri Singhapreecha for providing data and judgments. All errors are mine.

nouns and the Cl node. In Section 3 I will propose that the relevant link between nouns and auto-classifiers should be established in the post-syntactic component, in the form of a reduplication rule. In Section 4 I discuss how auto-classifiers bear on constituency in the NP. I round off the paper with my conclusions in Section 5.

2. Against the movement-based analysis

Auto-classifiers have not been fully appreciated in the existing literature; explicit discussion of this phenomenon is always brief and somewhat tangential to some other main point. Their first treatment, to my knowledge, appears in Simpson (2005), where it is suggested that auto-classified nouns such as *heetpon* ‘reason’ in (2) undergo head movement to Cl. The ‘doubling’ arises because chain deletion does not take place, so the noun is spelled out both in N and in the landing site Cl. On the other hand, nouns which take an ordinary, generalized classifier (such as *khon* ‘person’, *dek* ‘child’ or *nákrian* ‘student’ in (1)) stay in situ. In their case the Cl node is filled by insertion of a classifier listeme from the lexicon.

The major problem with this account is that whether a noun takes a generalized classifier or an auto-classifier is an idiosyncratic, listeme-based property of individual Thai nouns, which does not correlate with any other morphological or syntactic features. This means that the posited N-to-Cl movement would have to operate on a listeme-by-listeme basis. This is diametrically opposed to what characterizes syntactic operations in general: syntax is indifferent to which Vocabulary Item fills a particular slot. For comparison, in the clausal domain V-to-T and V-to-C are known to be sensitive to morpho-syntactic properties such as the main vs. auxiliary verb distinction or the finite vs. non-finite contrast, but neither movement makes a listeme-based distinction among main verbs (e.g. by applying to ‘read’ but not to ‘write’). The listeme-based nature of the posited movement stands in stark contrast to other, genuine cases of syntactic movement affecting Thai nominals as well. Since Cinque (2005), it has been an accepted thesis that NPs are cross-linguistically base-generated with the ‘Dem-Num-Adj-N’ order, with other word orders being derived via movement of the (potentially extended) NP. In this framework (also adopted in Simpson 2005), the ‘N-Num-Cl’ order of Thai is derived by N(P) fronting to a position above the numeral. As shown by (1) and (2), this movement affects auto-classified and regularly classified nouns alike. As expected from a narrow syntactic operation, this movement targets a morpho-syntactic class, that of common nouns, with no idiosyncratic exceptions.

The problem of forcing movement with an idiosyncratic subset of common nouns and at the same time preventing this movement from applying to the complement set is acknowledged and addressed in Simpson and Ngo (2018). As a solution, Simpson and Ngo propose that languages with auto-classifiers have a phonologically null classifier. This classifier selects for all and only auto-classified nouns. Crucially, the null classifier is affixal, and is thus in need of phonological support. Movement of the noun to Cl takes place in order to support the affix. As before, chain reduction does not take place, leading to a doubling of the noun.

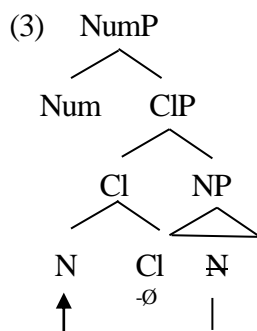

Overt generalized classifiers are morphologically free, on the other hand, so they do not trigger N-to-Cl. This way the movement becomes restricted to all and only auto-classified nouns.

There are several considerations, however, that weight against this approach. Firstly, the crucial ingredient of the analysis, namely the posited affixal nature of the null classifier, is not falsifiable. Secondly, this movement produces an unattested pattern in two respects. On the one hand, the ‘Num-N-Cl’ order is cross-linguistically unattested: as observed in Greenberg (1972), the noun never intervenes between the numeral and the classifier. On the other hand, affixal classifiers are known from a variety of languages (including some Southeast Asian languages), but they always form a phonological word with the numeral rather than the noun (even in the ‘Num-Cl-N’ order, affixal classifiers are suffixes to the numeral rather than prefixes to the noun).

Thirdly, in recent models of syntax embracing late insertion, where syntax manipulates abstract morphemes with no phonological content, the analysis encounters a problem in the ordering of operations. N-to-Cl is assumed to take place in narrow syntax. As a functional head, the Cl node is subject to late insertion. Since a specific classifier listeme is inserted to Cl only in the post-syntactic component, the classifier becomes affixal or morphologically free only at this stage. That is, the property that is supposed to trigger the movement becomes accessible only after the movement has taken place.

One possible way to address this issue is to assume that N-to-Cl takes place post-syntactically, after Vocabulary Insertion, when information about the affixal nature of the classifier is already available (i.e. it is a case of Vocabulary sensitive movement in the sense of Embick and Noyer 2001). However, as discussed in Embick and Noyer (2001: 561), post-syntactic movements ‘do not leave traces or their equivalents’. Thus if the movement is post-syntactic, no reference to chains can be made, and so the doubling of the noun cannot be accounted for. In addition, relegating the movement to the post-syntactic component also raises the question of why the classifier’s need for a host is not taken care of by Lowering of the ‘needy’ element, the classifier itself.

Finally, the head movement analysis (whether syntactic or post-syntactic) cannot account for the pattern observed with compounds headed by auto-classified nouns. With these compounds we get the so-called semi-repeater construction, whereby only the head is doubled in the classifier position (Hundius & Kölver 1983). This is illustrated with the auto-classified noun *prathêet* ‘country’ and its compound *prathêet-samŭn* ‘satellite country’ in (5). (Note that Thai nominal compounds are right-headed.)¹

¹ Pornsiri Singhapreecha (p.c.) informs me that repeating the whole compound would be fully ungrammatical in (5), though there are other compounds where either a semi-repeater or a full repeater would be possible, with

(4) prathêet sǎam prathêet
 country three CLF:country
 ‘three countries’ (Hundius & Kölver 1983)

(5) prathêet-samŭn sǎam prathêet
 country-satellite three CLF:country
 ‘three satellite countries’ (Hundius & Kölver 1983)

The movement analysis would have to assume that the head of the compound can move away from the non-head part, an operation that is otherwise unattested in Thai. Compare the movement that fronts nominals to the pre-numeral position:

(6) kĕew-nám sǎam bay (7) *kĕew sǎam bay nám
 glass-water three CLF glass three CLF water
 ‘three glasses’ Intended: ‘three glasses’ (Pornsiri Singhapreecha, p.c.)

Based on the foregoing discussion, I conclude that auto-classifiers should not and cannot be captured in the syntactic module of grammar.

3. A post-syntactic account of auto-classifiers

In the previous section we saw that auto-classifiers involve lexical idiosyncrasy, and this prevents successfully capturing them in narrow syntax, a module with systematic operations targeting (classes of) abstract feature properties. The repository of idiosyncratic information is the lexicon, and idiosyncratic processes can be initiated in the post-syntactic morphological module of grammar after Vocabulary Insertion (see Embick and Noyer 2001 for an overview). Below I will put forth a theory of auto-classifiers in which precisely this happens: an idiosyncrasy of a listeme in the mental lexicon triggers a post-syntactic morphological process.

3.1 Auto-classifiers as reduplication

I adopt a Late Insertion model whereby syntax operates on abstract features and Vocabulary Insertion takes place after syntax. The Exponent List of Thai contains dozens of classifier Vocabulary Items: *khon* is used for people except for sacred and royal ones, *rŭup* classifies priests and idols of deities, *tua* combines with nouns denoting animals, *lĕm* is for long and pointed or sharp objects, *baj* is for leaves, leaf-life objects and containers, etc. (see Hundius and Kölver 1983). These are all suitable for spelling out an abstract CI node. Which one of them is chosen in a particular NP depends on which nominal listeme the NP is projected from: as discussed in Embick (2015: 92), it is generally the case that if more than one listeme is suitable for insertion, then ‘the winner is determined by a morpheme local to the morpheme undergoing insertion’. That is, the Vocabulary Items for classifiers come with contextual information which restricts their use to the context of specific roots.

a slight difference in meaning. While the nature of this variation requires further research, what is important for our purposes is that the semi-repeater construction (5) is always possible.

(8) some Vocabulary Items of Thai

- a. Cl ↔ *khon* / {*dek* ‘child’, *nákrian* ‘student’, etc.}
- b. Cl ↔ *rûup* / {*chii* ‘ascetic’, etc.}
- c. Cl ↔ *lêm* / {*khêm* ‘needle, pin’, *takraj* ‘scissors’, *dàap* ‘sword’, etc.}
- d. Cl ↔ *baj* / {*thánábàt* bank note, *túa* ticket, *tùm* earthen jar, etc.}
- e. [...]

As shown in (8), the Vocabulary Items of generalized classifiers are each associated with a specific, permanent phonological form on the sound side. Via the Encyclopedia, they are also supplied with some meaning (sacred or non-sacred, long, pointed, flat, etc.).

I suggest that auto-classifier languages, including Thai, have no phonologically null classifier; that is, they have no classifier listeme which is associated with an empty phonological string, Ø. I propose instead that in Thai and other auto-classifier languages the set of Vocabulary Items suitable for spelling out Cl also includes a listeme which is associated neither with a specific, permanent phonological form in the Lexicon, nor with any lexical-semantic information in the Encyclopedia.² This classifier occurs with auto-classified nouns, and it is associated to phonology via reduplication: it copies the melody of the noun, and therefore its actual form depends on which specific nominal root projects the NP.

(9) Cl ↔ REDUPLICATION / {*prathêet* ‘country’, *pâw* ‘target’, *taa* ‘eyes’, etc.}

In Section 2 I cited Jenks (2011) for the view that the source of auto-classifiers should be grammatical rather than lexical. The approach presented above is not lexical in the sense that it does not assume five hundred different classifiers in the Lexicon for the five hundred different auto-classified nouns. That is, there is no lexical entry for a classifier whose phonology is permanently *prathêet* and which selects only for the noun *prathêet* ‘country’, nor is there an unrelated lexical entry for a classifier whose phonology is permanently *pâw* and which selects only for the noun *pâw* ‘target’, etc. All auto-classified nouns occur with the same classifier, the one whose phonology is produced by reduplication.³ Reduplication is a grammatical process of the post-syntactic component, thus in the relevant sense, auto-classifiers have a grammatical rather than a lexical origin indeed.

The literature distinguishes between two major types of reduplication: phonological and syntactic (see Travis 2001 for a more detailed picture). Phonological reduplication is sensitive to phonological domains. It expands the word in the form of affixes (as Frampton 2009: 3 puts it, it is ‘the surface manifestation of nonconcatenative inflectional morphology’) and adds further semantic content to the word, typically (though not exclusively) that of plurality, iterativity or emphasis. A typical example of this type of reduplication is the *kaldij* ‘goat’ ~ *kal-kaldij* ‘goats’ plural alternation in Ilocano (Frampton, 2009: 7).

Auto-classifiers clearly do not involve phonological reduplication: they do not expand the word that supplies the phonological material for reduplication (in our case, N) or create affixes. In fact, most auto-classifiers languages have the ‘N-Num-Cl’ order, where the

² This means that the meaning contribution of auto-classifiers to NP is purely formal: it consists in the division of mass (Borer 2005) without additional information on what sort of units (e.g., long, flat, animate, sacred, etc.) are created in the course of the division.

³ The analysis thus concurs with Burling’s (1965: 250) view that auto-classifiers are all ‘allomorphic variants of the same morpheme’.

nominal base and the reduplicant classifier are not even surface-adjacent. Furthermore, not only do they not involve the typical semantics of plurality, iterativity or emphasis, but they seem to add no meaning at all: they simply satisfy a formal requirement to fill the Cl slot.

Syntactic reduplication operates on syntactic rather than phonological domains. It consists in copying (part of) the melody from a reduplicative head's syntactic complement domain and inserting it 'into a position that is already syntactically available' (Travis 2001: 465). In the context of syntactic reduplication, Travis discusses cases such as *cup (of coffee) after cup of coffee*, *cup after steaming cup of coffee* or *steaming cup (of coffee) after steaming cup of coffee*. She suggests that in these examples a reduplicative head (spelled out by the preposition) takes a phrasal complement. (Part of) this complement's segmental information is borrowed and inserted into the specifier of the reduplicative head, as shown in (10). Wang and Holmberg (2021) discuss a related but slightly different configuration for syntactic reduplication: they show that in Traditional Xining Chinese the functional head *n* initiates reduplication if its complement N is monosyllabic (e.g. *sū* → *sū sū* 'lock_N'). The insertion of the borrowed melody here targets the functional head *n* itself. This is schematized in (11).⁴

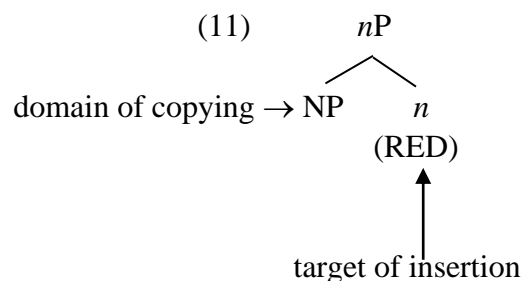
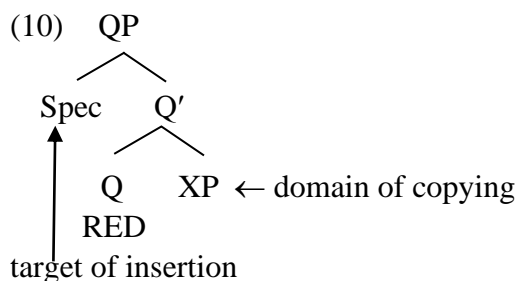

What is common to the two configurations is that i) reduplication is initiated by a syntactic (potentially functional) head, ii) what is copied is (part of) the melody of this head's complement, and iii) the copying consists in the borrowing of segmental information (i.e. melody) without concomitant copying of syntactic structure. That is, syntactic reduplication is crucially different from movement: the former operates purely on melody, while the latter operates on abstract morpho-syntactic features. (Whether the borrowed melody is inserted into a specifier or a head is likely related to the amount of melody that has been copied: the melody copied from a single morpheme or a complex head may 'fit' into the slot for a head, but the melody copied from a larger phrase won't.)

I suggest that auto-classifiers involve syntactic reduplication as in (11), with the melody of N serving as the base and the Cl node serving as the point of insertion for the borrowed segmental information. This way the lexical entry of N is tightly connected to the exponence of the Cl node, but no movement (syntactic or post-syntactic) is involved.

⁴ The reduplicative feature is placed in parentheses in (11) because reduplication is obligatory only if the complement is monomorphemic and monosyllabic at the same time. See Wang and Holmberg (2021) for details. Note that reduplication in Xining Chinese simply satisfies the formal requirement that N should have two syllables; it has no semantic import at all.

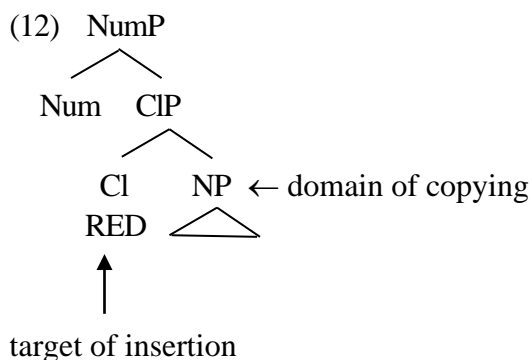

This approach avoids the problems raised by the analysis of Simpson (2005) and Simpson and Ngo (2018). Whether a noun takes a generalized classifier or an auto-classifier is captured via the Lexicon, the repository for listeme-based, idiosyncratic properties. The analysis does not assume an independently unattested word order (with a copy of the noun intervening between the numeral and the classifier), nor does it assume the unattested affixation of the classifier onto the noun. There is no paradox regarding the ordering of operations either: auto-classifiers arise in the post-syntactic component during Vocabulary Insertion, at a point where phonological content is supplied to abstract morphemes and thus Vocabulary sensitive operations can legitimately take place.

The reduplication analysis can also make sense of the semi-repeater construction, shown in (5) and repeated below for the reader's convenience as (15). On the movement analysis, these were an obvious embarrassment, as heads and non-heads of compounds don't generally separate from each other via syntactic movement.

- (15) prathêet-samŭn sãam prathêet
 country-satellite three CLF:country
 'three satellite countries' (Hundius & Kölver 1983)

I suggest that semi-repeaters are a case of partial reduplication, a phenomenon well known in the literature. The *kaldîŋ* 'goat' ~ *kal-kaldîŋ* 'goats' alternation of Ilocano mentioned above is an example of partial phonological reduplication, with only part of the relevant phonological domain undergoing melody copying. In Travis' approach, *cup after steaming cup of coffee* is an example of partial syntactic reduplication, where again only part of the relevant syntactic domain (here: *cup* from the phrase *steaming cup of coffee*) undergoes melody copying. Wang and Holmberg (2021) also discuss a case of partial syntactic reduplication from Traditional Xining Chinese. Recall that in this language *n* obligatorily triggers reduplication if its complement N is monosyllabic (e.g. *sū* → *sū sŭ* 'lock_N'). If the complement nominal of *n* is a bisyllabic compound, then *n* can trigger reduplication of just the head of the compound, e.g. *mēi hŭ* 'ink box' → *mēi hŭ hú* 'ink box'. (Reduplication of the non-head part or the entire compound is ungrammatical.)

I suggest that semi-repeaters are similarly a case of partial syntactic reduplication, where only part of the reduplicative classifier's complement domain undergoes melody copying. They are thus quite similar to the partial reduplication of compounds in Xining Chinese: in both cases, it is possible for melody copying to target just the head of a compound and to insert this borrowed melody to spell out a functional head in the extended NP. Copying just the head of a compound keeps the mechanism of segmental borrowing minimal but at the

same time allows the abstract CI node to be associated with a phonological string. In this sense, it is the optimal solution to the problem of how to expone a CI node with no permanent, invariable phonological material associated to it.

3.2 Variation across auto-classifier languages

There is cross-linguistic variation among auto-classifier languages regarding the division of labor between generalized classifiers (8) and CI:RED (9). In Ersu (Sino-Tibetan) there is a clear-cut complementary distribution between the two types of CIs: generalized classifiers are used whenever possible, and the CI:RED producing auto-classifiers is licit only if the noun is not compatible with any of the other existing classifiers in the language (Zhang, 2014). Ersu thus uses auto-classifiers as a last resort, in order to meet the formal requirement that all abstract syntactic nodes must be paired with some Vocabulary Item during Vocabulary Insertion. The reduplicative classifier of Ersu can thus be characterized as an elsewhere case, and therefore it is not necessary to include contextual information in the vocabulary entry of CI:RED (it will be used whenever the noun projecting the NP is not among the contextual restrictions of the other, generalized classifiers).

The situation in Thai is similar, but not identical to that in Ersu. Jenks (2011: 94) observes that ‘the repeater construction seems to be a kind of last resort’, and is employed whenever none of the generalized classifiers is appropriate. However, there are also cases when either a generalized classifier or an auto-classifier can be used. (13) has the same meaning regardless of whether the generalized classifier *râaŋ* and the auto-classifier *panhăa* is employed (Pornsiri Singhapreecha, p.c). (A similar pattern is reported for Burmese in Pe 1965.)

- (13) *panhăa săam panhăa/râaŋ*
 problem three CLF:problem/CLF.story
 ‘three problems’ (Jenks 2001: 94)

Since auto-classifiers are not used exclusively as a fall-back option in Thai, it is not possible to leave the vocabulary entry of CI:RED entirely without contextual specification. The nouns which show the alternation in (13) simply have to be listed as a contextual specification for both one of the generalized classifiers and CI:RED. Nouns allowing more than one classifier, without a concomitant change in meaning, are independently attested in Thai, so this approach fits with the general characteristics of classifier expressions in the language. Consider the following example from Hundius and Kölver (1983). All three classifiers produce the meaning ‘mango fruit’; *lûuk* and *baj* are fully interchangeable, while the Pali loan word *phôn* differs from these only in that it invokes a different stylistic level (it is more elegant).

- (14) *mamûaŋ săam lûuk/baj/phôn*
 mango three CLF.fruit/CLF.leaf/CLF.fruit
 ‘three mangoes’ (Hundius and Kölver 1983)

4. Consequences for NP structure

The constituent structure of NPs with classifiers has been subject to debate in the literature for a long time. According to one view, the classifier takes the noun as its complement (16).

On the other approach, the classifier sits in a left branch together with the numeral, either as an adjunct or as a specifier (17).

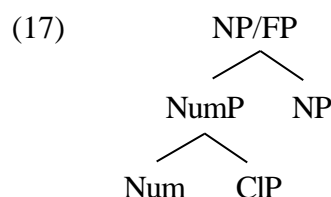
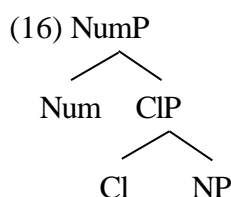

Choosing between the two structures on the basis of empirical arguments has been elusive. Most recently, the debate focused on variation within classifier languages, specifically, languages in which either particular numerals or particular nouns require a classifier in counting contexts, while other numerals or nouns block classifiers (Bale and Coon 2014, Simpson and Ngo 2018, Little et al. to appear, Dékány to appear). Even in this narrow domain, however, different researchers have reached different conclusions.

Auto-classifiers provide a new, so far overlooked argument in favor of the structure in (16). Whether they are derived by movement or reduplication, auto-classifiers require a head-complement relation between the Cl node and the NP. On the movement account, this is straightforward: neither head movement nor phrasal movement can take a node from the main projection line to a position inside a specifier. At the same time, the reduplicative view is also exclusively compatible with (16). As discussed in Travis (1999, 2001), syntactic reduplication copies melody from the reduplicative head's syntactic complement domain. This means that the borrowing of segmental information from N to Cl can take place in (16) but not in (17).⁵

5. Conclusions

This paper examined auto-classifiers, a subtype of numeral classifiers whereby the noun itself is repeated in the classifier position. I supported Jenks' (2011) view that the source of auto-classifiers is grammatical, but I argued against an account in terms of syntactic head movement. I suggested that auto-classifiers arise in the post-syntactic module of grammar, via a (potentially partial) reduplication operation of the type outlined in Travis (1999, 2001).

Simpson (2005) draws a parallel between classifier structures and expletive subjects in English. As is well known, with (non-alternating) unaccusative predicates Spec, TP can be filled either by first-merge of an expletive (*There came three new sailors on board*, Haegeman 1994: 335) or by movement (*Three new sailors came on board*). In Simpson's approach the Cl node can similarly be filled by either first-merge (of a generalized classifier) or by movement (of the noun). He points out that in this sense, generalized classifiers 'pattern a little like expletives' (fn. 8). The proposal in this paper turns this claim around. While I suggested that neither generalized classifiers nor auto-classifiers involve movement, auto-classifiers pattern a bit like expletives in the sense that they are employed because of a formal

⁵ On (17), one may try to capture auto-classifiers by assuming that their source is exclusively lexical: for each auto-classifier, there is a separate Cl entry in the lexicon, such that that Cl occurs only with the form-identical N. This cannot capture the observation that auto-classifiers are 'a kind of last resort' (Jenks 2011: 94), and it also loses the insight that auto-classifiers are allomorphs of each other. This is also difficult to maintain in view of the relative productivity of the pattern (as pointed out above, auto-classifiers are used for about five hundred nouns in Thai).

requirement which mandates that a certain position in syntax must be filled overtly. An analogy between expletives and auto-classifiers (rather than between expletives and generalized classifiers) is more appropriate from a semantic point of view as well: while generalized classifiers do have some semantic contribution to the structure (regarding the animacy, shape, size, function or other inherent qualities of the referent), auto-classifiers make no similar contribution.

References

- Aikhenvald, Alexandra Y. 2000. *Classifiers*. Oxford: Oxford University Press.
- Bale, Alan, and Jessica Coon. 2014. Classifiers are for numerals, not for nouns: Consequences for the mass/count distinction. *Linguistic Inquiry* 45:695–707.
- Borer, Hagit. 2005. *Structuring sense*, volume I. New York: Oxford University Press.
- Burling, Robins. 1965. How to choose a Burmese numeral classifier. In *Context and meaning in cultural anthropology*, ed. Melford E. Spiro, 243–264. New York: Free Press.
- Cinque, Guglielmo. 2005. Deriving Greenberg's Universal 20 and its exceptions. *Linguistic Inquiry* 36:315–332.
- Dékány, Éva. To appear. Classifiers for nouns, classifiers for numerals. In *Proceedings of NELS 52*, ed. Breanna Pratley, Özge Bakay, Eva Neu and Peyton Deal. Amherst: GLSA.
- Embick, David, and Rolf Noyer. 2001. Movement operations after Syntax. *Linguistic Inquiry* 32: 555–595.
- Frampton, John. 2009. *Distributed reduplication*. Linguistic Inquiry Monographs 52. Cambridge, MA: MIT Press.
- Greenberg, Joseph H. 1972. Numeral classifiers and substantival number: Problems in the genesis of a linguistic type. *Working Papers on Language Universals* 9:1–39.
- Haegeman, Liliane. 1994. *Introduction to Government and Binding Theory*. 2nd ed. Oxford: Blackwell.
- Hundius, Harald, and Ulrike Kölver. 1983. Syntax and semantics of numeral classifiers in Thai. *Studies in Language* 7:165–214.
- Jenks, Peter. 2011. *The hidden structure of Thai Noun Phrases*. Doctoral Dissertation, Harvard University, Cambridge, MA.
- Jones, Robert B. 1970. Classifier constructions in Southeast Asia. *Journal of the American Oriental Society* 90:1–12.
- Little, Carol Rose, Mary Moroney, and Justin Royer. To appear. Classifiers can be for numerals or nouns: Two strategies for numeral modification. *Glossa*.
- Pe, Hla. 1965. A re-examination of Burmese 'classifiers'. *Lingua* 15:163–185.
- Piriyawiboon, Nattaya. 2010. *Classifiers and determiner-less languages: The case of Thai*. Doctoral Dissertation, University of Toronto.
- Simpson, Andrew. 2005. Classifiers and DP structure in Southeast Asia. In *The Oxford handbook of comparative syntax*, ed. Guglielmo Cinque and Richard S. Kayne, 806–838. New York: Oxford University Press.
- Simpson, Andrew, and Binh Ngo. 2018. Classifier syntax in Vietnamese. *Journal of East Asian Linguistics* 27:211–246.
- Travis, Lisa. 1999. A syntactician's view of reduplication. *Toronto Working Papers in Linguistics* 16:313–330.
- Travis, Lisa. 2001. The syntax of reduplication. In *Proceedings of NELS 31*, ed. Minjoo Kim and Uri Strauss, 454–469. Amherst: GLSA.
- Wang, Qi, and Anders Holmberg. 2021. Reduplication and the structure of nouns in Xining Chinese. *Natural Language & Linguistic Theory* 39:923–958.
- Zhang, Sihong. 2014. Numeral classifiers in Ersu. *Language and Linguistics* 15:883–915.

Hyper-raising and the subject position in Brazilian Portuguese

Tarcisio Dias

University of Connecticut

1. Introduction

In this paper I propose that Brazilian Portuguese (BP) subjects occupy a mixed A/A' position between Spec,CP and Spec,TP (i.e., Spec,A/A'P) and argue that hyper-raising constructions are derived via movement to this position as depicted in (1).

(1) [CP [A/AP DP_i [TP ... [CP [A/AP t_i [TP ...

I also claim the subject is not frozen for movement in the embedded finite clause because feature checking there involves the A/A' projection, and not a pure A or A' projection. I am using "hyper-raising" (HR) in the sense of Ura (1994), thus referring to "languages that allow raising from the **subject** position of a tensed (or finite) clause" (p.65; emphasis added by the author). Consider (2).

- (2) a. Os meninos parecem que *t* comeram maçã.
 the boys seem.3PL that ate.3PL apple
 'It seems that the boys have eaten apples'
- b. *pro*_{EXPL} Parece que os meninos comeram maçã.
 seem.3SG that the boys ate.3PL apple
 'It seems that the boys have eaten apples'

Notice that the 3rd person plural DP subject *os meninos* ('the boys') triggers agreement with both verbs in the embedded and in the matrix clause (2a). When movement doesn't take place, an expletive *pro* is inserted instead, satisfying matrix EPP and triggering default (3SG) agreement (2b). HR constructions like (2a) are challenging since subject raising out of finite clauses is expected to violate the Activation Condition (Chomsky 2000, 2001), as movement from a Case-checking position to another Case-checking position is arguably banned (cf. **The boys seem (that) are happy*). In other words, DPs that have entered a Case-checking relation should be frozen in place and no longer move. Another potential issue is improper movement, as movement through the embedded Spec,CP to the matrix position would qualify as movement from an A' position to an A position (e.g., from embedded Spec,CP to matrix Spec,_vP). In the following, I will argue BP subjects occupy a mixed A/A' position which allows HR constructions to be derived without inducing freezing effects.

The proposal that subjects in HR languages occupy Spec,A/A'P straightforwardly accounts for the mixed A/A' properties of BP subjects and will also account for the unavailability of a subject-object inverse scope reading in the language. I also claim that movement out of A/A'P voids the freezing effect of feature checking. Such movement recreates the configuration needed for agreement in the matrix clause, which makes the same DP trigger agreement both in the embedded and in the matrix clause.

2. The data: hyper-raising in Brazilian Portuguese

One could wonder whether the trace in (2a) isn't actually *pro*. In this section I will show it is not, as has been argued in the literature. First, BP does not allow referential 3rd person null subjects, which would make the licensing of *pro* in embedded clauses unexpected.

- (3) *Embarcou no trem .
 boarded.3SG in.the train
 'He/She boarded the train' Rodrigues (2004:03)

Also, 3rd person null subjects in embedded contexts are not free in reference, being dependent on the matrix DP subject.

- (4) Ele₁ disse que e_{1/*2} embarcou no trem.
 He said that boarded in.the train
 'He said that he boarded the train' Rodrigues (2004:03)

As observed by Duarte (1996), BP null subjects in embedded finite clauses do not obey the *Avoid Pronoun Principle*¹ (APP), thus allowing overt non-emphatic subject pronouns instead of *pro* (5). The null subject in BP alternates freely with the overt pronoun, which suggests that the former is not *pro*, given that *pro* cannot be involved in such free variation (cf. Montalbetti's 1984 Overt Pronoun Constraint).

- (5) O João disse que (ele_{1/2}) gosta da Maria.
 the João said that he likes of.the Maria
 'João said that he likes Maria' Rodrigues (2004:79)

Notice that the null subject freely alternates with the overt pronoun, which shows that the latter is not being "avoided" in any sense. The silence in (5) being a trace is fully compatible with the APP. Additional evidence that the matrix subject is derived via movement can be seen in (6), where a null subject is prohibited within the relative clause.

- (6) a. Parece que [o bolo que o João comeu não tava bom.]
 seems that the cake that the João ate not was good
 'It seems that the cake that João ate wasn't good'
 b. *O João parece que [o bolo que t comeu não tava bom.]
 the João seems that the cake that ate not was good Nunes (2008:10)

Also, reconstruction effects are attested for HR constructions. In (7) we see that subject DPs of sentential idioms can hyper-raise.

- (7) a. A vaca foi pro brejo.
 the cow went to.the swamp
 'Things went bad.'

¹"Empty categories have preference over overt pronouns" (Chomsky 1981:65).

- b. A vaca parece que foi pro brejo.
 the cow seems that went to.the swamp
 'It seems that things went bad.'

Finally, in (8) the matrix DP *ninguém* ('nobody') licenses the embedded Negative Polarity Item (NPI) *um dedo* ('a finger').

- (8) a. Ninguém mexeu um dedo pra me ajudar.
 nobody moved a finger to me help
 'Nobody lifted a finger to help me'
- b. *Ninguém disse [que a Maria mexeu um dedo pra me ajudar.]
 nobody said that the Maria moved a finger to me help
 'Nobody said that Maria didn't lift a finger to help me'
- c. Ninguém parecia [que *t* ia mexer um dedo pra me ajudar.]
 nobody seemed that went move a finger to me help
 'It seemed that nobody was going to lift a finger to help me' Nunes (2008:11)

Notice that the null subject in (8c) being a trace is compatible with the requirement that the NPI licenser and the NPI must be clause mates. Therefore, I take null subjects of embedded clauses of HR constructions to be traces (i.e., deleted copies) of movement, in line with the available literature.

3. Previous accounts to hyper-raising in Brazilian Portuguese

3.1. The φ -incomplete finite T approach to hyper-raising

As observed in Nunes (2008:86), Ferreira (2000, 2004, 2009) and Rodrigues (2002, 2004) have argued that with the weakening of the verbal paradigm in BP, the finite T in the language ceased to license referential *pro*, and referential null subjects were reanalyzed as A-traces. Ferreira (2000, 2004, 2009) suggests that BP finite Ts are φ -ambiguous, that is, they could either be associated with a complete or with an incomplete set of φ -features. In this approach, a φ -complete T would freeze the subject in the embedded clause by assigning structural nominative Case to it, deriving (2b). A φ -incomplete T, on the other hand, would fail to assign nominative Case, which would make the embedded subject eligible to move into the matrix clause, thus deriving (2a). This is under the assumption by Chomsky (2000, 2001) that nominative Case is assigned as a side effect of φ -complete agreement between T and the subject, which correctly predicts the impossibility of movement in **John seems (that) is tired*, but the need for movement in *John seems to be tired*.

Nunes (2008) implements this idea by suggesting that (i) person and number features can be combined either in the numeration or in the morphological component, which would allow a "personless" (φ -incomplete) T in syntax, and that (ii) nominative pronouns in BP are underspecified (cf. Nunes 2020), which would also account for the "weakening" in BP verbal inflection. The motivation for underspecification in the pronominal system refers to the loss of verbal inflection in BP, where 2nd singular, 3rd singular, and 1st plural pronouns all trigger default agreement (3rd singular) on the verb (9a). 2nd plural and 3rd plural pronouns, on the other hand, trigger 3rd plural agreement (9b).

- (9) a. *Você/ Ele/Ela/A gente* *canta*
 you.SG/ he/ she/ we sing-PRES.IND.3SG
 'You/He/She/We sing(s)'
 b. *Vocês/ Eles/ Elas* *canta-m*
 you.PL/ they.MASC/ they.FEM sing-PRES.IND.3PL
 'You/They sing'

He accounts for (9) by claiming the pronouns in (9a) are radically underspecified for person and number, and the ones in (9b) have only a number feature (i.e, plural). The pronouns *eu* ('I') and *nós* ('we'), on the other hand, would be specified with only one feature, which he claims is enough to identify them: the former is specified as [Person.Number: SG], and the latter as [Person.Number: 1]. He shows that you only need the singular value to identify the 1st person singular pronoun morphologically, since there is no person distinction between the singular forms *você*, *ele*, *ela* and *a gente*. In the case of *nós*, however, we only need the person value "1", since the plural forms *vocês*, *eles* and *elas* have no person distinction morphologically expressed (see 10; remember that BP uses 3rd person as default).

- (10) *Eu cant-o /* *Nós* *canta-mos*
 I sing-PRES.IND.1SG/ we sing-PRES.IND.1PL
 'I sing/'We sing'

It is not at all clear to me how Brazilian Portuguese nominative pronouns will end up being properly interpreted if they are "maximally underspecified" (Nunes 2020:4659). If the pronouns *você* (2sg), *ele* ('he'), *ela* ('she'), and *a gente* ('we') are equally unspecified for person and number, where the different interpretations that we obviously still have among them would be encoded? How is the semantic component going to distinguish the 2nd person singular from the 3rd person singular if they are identical objects in the derivation? The fact the morphological component is able to properly realize the agreement inflections without needing to access a full specification of person and number features is not itself evidence of underspecification of the pronominal system. Syncretism across "cells" in agreement patterns is a phenomenon widely attested cross linguistically, and there is plenty of work within the Distributed Morphology framework, for instance, that deals with such cases as underspecification in the phonological exponents, but not in the syntactic nodes, which are generally assumed to be fully specified.² Therefore, I don't see any reason to interpret the loss of inflection markers in BP as the aftermath of Agree with underspecified pronouns.

On the possible different timings of insertion of person and number features (either in the numeration or in the morphological component), which would allow a "personless" (φ -incomplete) T in syntax, no supporting evidence was presented, and I couldn't think of a way to test this claim, as T would always surface the same. Also, the only alleged "visible" effect of the proposed timing difference seems to be DP movement out of the finite domain, which is precisely the phenomenon the analysis aims to account for.

²Cf. subset principle: Harley & Noyer (1999:04). Underspecified vocabulary items compete for insertion into fully specified syntactic nodes. See also Sauerland's (1995) account of the syncretic pattern of Dutch strong adjectives desinences, which crucially relies on the subset principle.

3.2. The A features in C approach to hyper-raising

Fong (2018, 2019) shows that accusative subjects of embedded clauses in Mongolian are Case-marked by the matrix verb (and can therefore hyper-raise).

- (11) a. Bat chang-aar [Dorj sain sheetin gej] khel-sen.
 Bat loud-INST Dorj.NOM good noble COMP say-PST
 'Bat said loudly that Dorj is good and noble'
- b. Bat chang-aar Dorj [ec sain sheetin gej] khel-sen.
 Bat loud-INST Dorj.NOM good noble COMP say-PST
 'Bat said loudly that Dorj is good and noble' Fong (2018:02)

As already mentioned, Ferreira (2000, 2004, 2009) and Rodrigues (2002, 2004) show that embedded null subjects are traces of movement in BP sentences like (12), where the DP moves to a θ -position.

- (12) O João disse [t que comprou um carro].
 the João said that bought a car
 'João said that he bought a car' Ferreira (2009:29)

Now let's consider (13).

- (13) a. A Maria me viu (estudando).
 the Maria 1sg.ACC saw studying
 'Maria saw me (as I was studying)'
- b. Eu vi que t estou estudando pouco.
 I saw that am studying little
 'I realized I'm not studying much'

(13a) shows the verb *ver* ('see') assigns accusative Case. (13b) shows a construction where the embedded subject moves to a θ -position out of a finite clause, as in (12). Now look at (14).

- (14) *Me vi que t estou estudando pouco
 1sg.ACC saw that am studying little
 (Int.) 'I realized I'm not studying much'

Given that BP embedded finite subjects do indeed move to a θ -position in the matrix, I don't see how (14) would be excluded in Fong's approach, since we would expect the matrix verb to assign accusative to the embedded subject, which would therefore be able to raise as it happens in Mongolian's (11). Let's say that whatever mechanism typically assigns abstract Case in BP would be unavailable in the embedded clause in (12). Under Fong's analysis, the matrix verb, which is an accusative Case assigner, should be able to Case-mark the embedded subject as it does in (11b).

The analysis developed here differs from Fong (2018) in the following. She suggests HR in BP is derived by subject movement to Spec,CP triggered by A-features in C, which create A-positions. For her, HR is an instance of A-movement even though it passes through Spec,CP. Here, HR will not be derived via movement to Spec,CP, but to a lower position, Spec,A/A'P.

3.3. C as a composite A/A' probe

Lohninger, Kovač & Wurmbrand (2022) propose that the matrix predicate in HR constructions as in BP lexically selects a special CP, i.e., "CP.R", which "bundles the A-properties of a predicational R[elator]P[hrase] [...] with the A'-properties of a (regular) CP" (p.12).³ They claim that the mixed A/A' nature of this projection allows the DP in its Spec to be targeted by matrix A-probes without involving improper A-after-A' dependencies. Notice, however, that our analyses are not notational variants. The CP.R projection is restricted to HR constructions, and it is not a (locally moved) subject-dedicated position as Bošković's (2021, in press) A/A'P, which is the projection I will rely on in the analysis to be developed here. Our approaches also make different predictions. If Fong (2018) is correct in her proposal that a composite A/A' probe in C is responsible for deriving hyper-raising to **object** in Kipsigis (15) (p.13-4),⁴ then it's not clear to me how we would be able to prevent HR to object in BP under the CP.R approach, which is ungrammatical (16).

- (15) mócè pè:ndó Mù:sá [kó-tíl Kíplàjàt].
 wants meat Musa 3S.SUB-cut Kiplangat
 'Musa wants that Kiplangat cut the meat.' Jake & Odden, 1979 (11)

- (16) *O bolo parece que o João comeu.
 the cake seems that the João ate
 'The cake seems that John ate.'⁵

4. A/A'P

Bošković (2021, in press) has independently argued for the existence of a subject-dedicated position above TP and below CP, claiming it is an instance of a mixed A/A' position. He shows this position hosts local *wh*-subjects, which move straight to this position without passing through Spec,TP. This projection doesn't host *wh*-objects, embedded (long-distance moved) *wh*-arguments, and *wh*-adjuncts, which all move to Spec,CP instead. As an A/A' position, it can (i) satisfy EPP,⁶ (ii) check nominative Case, (iii) check the [+WH] feature and, I will argue, trigger agreement.

He shows that *who* in *who left?* is neither in Spec,TP nor in Spec,CP, but it must be in between. West Ulster English allows quantifier float under *wh*-movement (cf. 17). One argument that *who* is not in Spec,TP is that a subject in Spec,TP is unable to float a quantifier in the θ -position in passive (17b). If *who* in (17a) were to pass through Spec,TP (or if it were located in Spec,TP), the quantifier would be floated from the same position in both (17a) and

³Cf. also Wurmbrand (2019a, b).

⁴An appropriate goal for this type of hybrid probe has to have matching features. If the embedded subject does not have them, it will be skipped over them. Conversely, if the object bear A/A'-features, it will be an adequate goal, allowing it to be hyper-raised." (Fong 2018:14).

⁵A focused or topicalized object is allowed, but it would require a comma intonation separating the fronted object with the rest of the clause. This is of course not the relevant derivation here.

⁶In Bošković's proposal, the A/A'P is the highest projection in the EPP domain, which corresponds to a return to split IP. In his system, EPP is checked in the highest projection of the EPP domain, i.e., Spec,A/A'P. Such domain looks like (i). For instance, English regular subjects would be in Spec,AgPs, quirky subjects are good candidates for Spec,TP.

(i) [A/A'P [AgPs [TP ...

(17b), so the former should be ungrammatical. Therefore, the *wh*-subject in (17a) moves above TP, which means it must be able to satisfy the EPP and get nominative Case above TP.

- (17) a. Who [_{TP} (**t*) was arrested all *t* in Duke Street?]
 b. *[_{TP} They were arrested all *t* last night.]
 c. What did [_{TP} he say all *t* that he wanted?] Bošković (2021:03)

However, *who* and *what* in (17) cannot occupy the same position in the left periphery. If that were the case, the contrast in (18) would be unexpected. Notice that the *wh*-object moves above the topic, a position unavailable for *wh*-subjects, suggesting the former is higher than the latter.

- (18) a. ?Mary wonders which book, for Kim, Peter should buy.
 b. *Mary wonders which student, for Kim, should buy that book. Bošković (2021)

Another interesting evidence that *wh*-subjects and *wh*-objects are in different positions comes from Igbo, a language spoken in southeastern Nigeria, where they are marked differently (19). Notice that the focus particle is obligatory with the former and prohibited with the latter.

- (19) a. Ònyé *(ka) Òbí hụrụ n'-áhíá?
 who FOC Obi saw P-market
 'Who did Obi see at the market?'
 b. Ònyé (*ka) hụrụ Ádá n'-áhíá?
 who FOC saw Ada P-market
 'Who saw Ada at the market?' Amaechi and Georgi (2019)

Further, the fact (20a) allows for an inverse scope reading shows that the object *everyone* scopes over a quantifier in Spec,TP, the regular subject position. Then, with the impossibility of inverse scope in (20b), he concludes *who* is not located in Spec,TP (cf. also Mizuguchi 2014), and it must be in Spec,A/A'P, as Spec,CP is also excluded (cf. 18).

- (20) a. Someone loves everyone. ($\exists > \forall$; $\forall > \exists$)
 b. Who loves everyone? ($\exists > \forall$; $*\forall > \exists$) Bošković (2021)

The A/A' position is not confined to *wh*-subjects. Bošković (2022) shows it can also host V2 subjects, *Only*-subjects, Imperative subjects, Locative inversion, Singlish non-agreeing subjects and Defaka focus subjects. Spanish (regular) subjects, Chinese subjects and quirky non-subjects are also good candidates for that position. In the next section I will argue that both *wh* and regular Brazilian Portuguese subjects occupy Spec,A/A'P. The mixed A/A' proposal captures the contrast we see between (21a) and (21b), in which extraction across *who* in the former is less degraded than extraction across *how* in the latter (cf. Chomsky 1986 where this contrast is reported). The account is given in (22).

- (21) a. ?What_i do you wonder who bought *t*_i?
 b. ??What_i do you wonder how she bought *t*_i? (Bošković 2022)
 (22) a. ?[_{CP} what do you wonder [_{A/A'P} who bought *t*]]
 b. ??[_{CP} what do you wonder [_{CP} how she bought *t*]]

5. A/A'P in Brazilian Portuguese

Local BP *wh*-subjects occupy Spec,A/A'P, as in English. Notice that BP displays the same topicalization pattern observed in (18), which indicates *wh*-objects are higher than *wh*-subjects (23).

- (23) a. Maria quer saber que livro, pro Pedro, o João comprou.
 Maria wants to.know which book to.the Pedro the João bought
 'Maria wants to know which book, for Pedro, João has bought.'
- b. *Maria quer saber que aluno, pro Pedro, comprou o livro.
 Maria wants to.know which student to.the Pedro bought the book
 (Int.) 'Maria wants to know which student, for Pedro, has bought the book.'

Another evidence for the availability of A/A'P in BP is the ellipsis data below. *Quem nunca* ellipsis is only available with a locally moved *wh*-subject (24b, 25b). With *wh*-objects (25c), long distance (LD) *wh*-arguments, including subjects, (25c,25d), and *wh*-adjuncts (26), this ellipsis is disallowed. The sentences in (a) correspond to the discourse antecedent of the elliptical constructions in (b-d). The non-elided versions of the ellipses being examined are all fully acceptable.

- (24) a. Pedro beijou João.
 Pedro kissed João
- b. Quem nunca [~~t~~beijou João]?
 who never kissed João?
 'Who has never kissed João?'
- c. *Quem Pedro nunca [~~t~~beijou t]?
 who Pedro never kissed
 'Who has Pedro never kissed?'
- (25) a. Maria disse que Pedro beijou João.
 Maria said that Pedro kissed João
- b. Quem nunca [~~t~~disse que Pedro beijou João]?
 who never said that Pedro kissed João
 'Who has never said Pedro kissed João?'
- c. *Quem Maria nunca [~~t~~disse que Pedro beijou t]?
 who Maria never said that Pedro kissed
 'Who has Maria never said Pedro kissed?'
- d. *Quem Maria nunca [~~t~~disse que t beijou João]?
 who Maria never said that kissed João
 'Who has Maria never said kissed João?'
- (26) a. Pedro beijou João na festa.
 Pedro kissed João at.the party
- b. *Onde Pedro nunca [t beijou João]?
 where Pedro never kissed João
 'Where did Pedro never kissed João?'

Only local *wh*-subjects are allowed in *Quem nunca* ellipsis constructions, whereas non-local *wh*-subjects (i.e., *wh*-objects, LD *wh*-arguments, *wh*-adjuncts) are not. This is exactly the cut predicted under the subjects-in-Spec,A/A'P analysis. By assuming with Lobeck 1995 that [+WH] Spec-head agreement is a necessary condition for ellipsis licensing in cases of sluicing, I propose that *nunca* heading the A/A' projection licenses ellipsis when it stands in a Spec-head relation with *Quem*_[+WH], which is only possible when *quem* corresponds to the local subject. Also notice that the *wh*-elements in (24b) and (25b) cannot correspond to the object. Check the table below for a summary.

(27) *Quem nunca* ellipsis

| | <i>Quem+nunca</i> XP | e.g., |
|-----------------------|----------------------|---------|
| local <i>wh</i> -Subj | ✓ | 24b,25b |
| local <i>wh</i> -Obj | * | 24c |
| LD <i>wh</i> -Obj | * | 25c |
| LD <i>wh</i> -Subj | * | 25d |
| <i>wh</i> -adjunct | * | 26b |

6. Brazilian Portuguese regular subjects occupy Spec,A/A'P

In this section I will claim that, just like locally moved *wh*-subjects, regular subjects in Brazilian Portuguese also occupy Spec,A/A'P.

6.1. Brazilian Portuguese regular subjects have mixed A/A' properties

Being in a mixed A/A' position, we expect BP subjects to exhibit both A and A' properties. Lacerda (2020) argues that BP subjects can receive an aboutness (AT) topic interpretation even without being in Spec,CP.⁷ In (28) we see that the aboutness topic object must be fronted to be licensed. *Já* (lit. "already") is an aboutness-shifting particle, used to introduce a (non-contrastive) discourse topic.

(28) A: O Pedro teve que ler o Programa Minimalista pra esse curso.

'Pedro had to read the Minimalist Program for this course.'

B1: Já o *Barriers*_{AT}, ele não teve que ler.

JÁ the *Barriers* he not had that to.read

B2: *Ele não teve que ler já o *Barriers*.

he not had that to.read JÁ the *Barriers*_{AT}

'As for *Barriers*, he didn't have to read it'

Lacerda (2020:25)

(28) shows that the aboutness topic object must be interpreted in a sentence initial position. This position, however, does not have to be Spec,CP.

⁷An anonymous reviewer pointed out that I misrepresented Lacerda's claim, "which actually states that subject in BP can be interpreted as topic even when they occupy Spec,TP". This is indeed the author's actual claim, but there is no A/A'P projection in his theoretical assumptions. If we interpret BP subjects as occupying Spec,A/A'P instead of Spec,TP we account for the topic reading without having to assume TP in the language hosts [Topic] features, which seems to treat BP as typologically exceptional. There doesn't seem to have any empirical loss in proposing BP subjects are actually in the A/A'P projection instead, which is equipped to handle both A (e.g., agreement) and A' (e.g., topic reading) properties. Additional motivation is required to sustain TP does the job, where this is expected under the A/A'P analysis.

(29) A: O Pedro leu dez livros do Chomsky pra esse curso.
 the Pedro read ten books of.the Chomsky to this course
 'Pedro read ten books by Chomsky for this course.'

B: Já o João_{AT} não leu nenhum.
 Já the João not read.3SG none
 'As for João, he didn't read any.'

Lacerda (2020:209)

The aboutness topic DP *o João* in (29) corresponds to a regular subject, thus triggering agreement in (29B). Also notice that no pause is required after the subject, contrary to B1 in (28). These facts can be captured if the subject is in Spec,A/A'P, a position that is able to license both A (e.g., agreement) and A' (e.g., topic) properties. Importantly, English does not allow subject topics (cf. Lasnik & Saito 1994, Bošković 2016).

Martins & Nunes (2010) and Rodrigues (2004) also observe that BP DP subjects exhibit topic behavior. For instance, topicalized possessives can occupy subject position, thus triggering verbal agreement. Also notice that such topic-subjects can hyper-raise (31).

(30) a. Os ponteiros do relógio quebrara-m.
 the hands of.the watch broke-PL
 'The hands of the watch broke.'

b. O relógio quebrou os ponteiros.
 the watch broke.SG the hand
 'As for the watch, its hand broke.'

(31) O relógio parece que quebrou os ponteiros.
 the watch seems that punctured the hands
 'As for the watch, it seems that its hands broke.'

The above is for the A' properties associated with A/A'P. For the A properties, we have seen that they trigger verbal agreement (cf. 2a, repeated below as 32).

(32) Os meninos parecem que *t* comeram maçã.
 the boys seem.3PL that ate.3PL apple
 'The boys seem to have eaten apples'

The data in section 2 show that HR in BP can be characterized as A-movement. For instance, we saw in (7b), repeated below as (33a), that DP subjects of sentential idioms, which generally resist A'-movement (cf. 33b), can hyper-raise. Only a non-idiomatic reading is available for (33b).

(33) a. A vaca parece que foi pro brejo.
 the cow seems that went to.the swamp
 'It seems that things went bad.'

b. *A vaca parece que ela foi pro brejo.
 the cow seems that it went to.the swamp
 (Int.) 'It seems that things went bad.'

Additionally, Fong (2018) shows HR in BP has another property of A-movement, namely, that hyper-raised subjects are able to bind variables without inducing weak cross-over effects.

- (34) Nenhum aluno₁ parece pro orientador dele₁ [t que entendeu a lição]
 no student seem.3SG for.the advisor of.he that understood the lesson
 'No student seems to his advisor to have understood the class.' Fong (2018:11)

Lastly, Ferreira observes that this position hosts negative quantifiers, which cannot be topicalized (i.e., cannot be in a pure A' position).⁸

- (35) a. Ninguém parece que entendeu o problema.
 nobody seems that understood the problem
 'Nobody seems to have understood the problem.'
 b. *Ninguém, o João disse que entendeu o problema.
 nobody the João said that understood the problem
 (Int.) 'João said that nobody understood the problem.' Nunes (2008:09)

I therefore propose that BP hyper-raising constructions are derived via movement from Spec,A/A'P in the embedded clause to Spec,A/A'P in the matrix one (cf. 1, repeated below as 36).

- (36) [CP [A/A'P DP_i] [TP ... [CP [A/A'P t_i] [TP ...

HR is then predicted only in languages where regular subjects can be in Spec,A/A'P. This is not improper movement, since it is not movement from a pure A' position (e.g., Spec,CP) to a pure A position (e.g., Spec,TP).

6.2. Scope rigidity and hyper-raising

We have seen that in English, even though regular DP subjects allow for an inverse scope reading (cf. 20a, repeated below as 37a), *wh*-subjects don't (cf. 20b, repeated below as 37b).

- (37) a. Someone loves everyone. ($\exists > \forall$; $\forall > \exists$)
 b. Who loves everyone. ($\exists > \forall$; $*\forall > \exists$) Bošković (2021)

⁸An anonymous reviewer acknowledged the discussion in the literature that shows the position occupied by hyper-raised subjects in BP does not count as an A'-position. They mention the fact HR subjects are compatible with idioms (38) and indefinite quantifiers (40), which cannot move to an A'-topic like position. This analysis does not state HR subjects go to a **pure** A'-position (i.e., Spec,CP), where such elements are definitely not expected. Crucially, the A/A' position is able to host elements that have performed A or A' movement. In other words, the A aspect of it is able to admit either a subject raised out of a sentential idiom or an indefinite quantifier. Stating it in terms of Boolean operators, the A/A' projection has to be understood as A **or** A', not as A **and** A', i.e., A-movement, A'-movement, and mixed A/A'-movement are all predicted to be allowed in Spec,A/A'P. This analysis doesn't imply that every movement targeting Spec,A/A'P should obligatorily exhibit mixed properties. An account that treats BP subjects as raisers to Spec,TP shouldn't expect it to exhibit A' discourse effects of the type mentioned here, since the language has a dedicated (pure) A' position for that (Spec,CP). Given there is independent motivation for Spec,A/A'P, it is to the advantage of this analysis to capitalize on it to account for subjects which display both A and A' characteristics.

Interestingly, (regular) BP subjects behave like wh-subjects regarding scope interaction. Assuming that the absence of inverted scope reading in (37b) is due to the wh-subject occupying a position higher than Spec,TP, thus blocking object inversion, I argue non-wh BP subjects also occupy this position (i.e., Spec,A/A'P). This provides a straightforward account of why BP resists an inverted scope reading in (38a). Notice that under HR the inverse scope reading is also impossible (cf. 38c).⁹

- (38) a. Alguém ama todo mundo. ($\exists > \forall$; $*\forall > \exists$)
 someone loves everyone
 b. Quem ama todo mundo? ($\exists > \forall$; $*\forall > \exists$)
 who loves everyone
 c. Alguém parece que ama todo mundo. ($\exists > \forall$; $*\forall > \exists$)
 someone seems that loves everyone

The proposal above gives rise to an empirical prediction: languages that exhibit hyper-raising are expected to be scope-rigid, at least in "subject precedes object" cases such as (38a). Notice that this is a one-way correlation: absence of inverse scope reading will not mean availability of HR. So far, the prediction is indeed borne out for several languages from different families listed in Ura (1994:65) as allowing HR. Here, I list HR languages that are also scope-rigid:

(39) **Scope-rigid hyper-raising languages:**

Mandarin Chinese (cf. Huang 1998), Japanese (cf. Hoji 1985), Korean (cf. Kim 2008), Persian (cf. Shafiei & Storoshenko 2017), Turkish (cf. Altınok 2017), Greek (cf. Baltazani 2002), Kinande (Bantu; cf. Baker 2003), Georgian (cf. Borise & Polinsky 2018), Finnish (cf. Zimmermann 2003), Tamil (cf. Sarma 2003), Sinhala (cf. Tim Chou & Hettiarachchi 2016). Hungarian, which exhibits HR (cf. den Dikken 2017), is also scope-rigid (cf. Kiss 2002). Spanish, which has HR according to Fernández-Salgueiro 2005 and Pires & Nediger 2018), is also claimed to be scope-rigid (cf. Alexiadou & Anagnostopoulou 1998).

7. Deriving hyper-raising in Brazilian Portuguese: the voiding of freezing effects

According to Bošković (2008), once X enters a feature checking relation, it is frozen in place and can no longer move. Crucially, X can only be probed once, regardless of the status of the probe (i.e., A or A').

- (40) X undergoes A [or] A' movement feature checking as a probe only once. Bošković (2008:24)

So:

⁹An anonymous reviewer said the data in (38) are not helpful because "Brazilian Portuguese displays surface scope even when subjects are not involved" as in *O João apresentou alguém pra todo mundo* ('João introduced someone to everyone'), with the existential quantifier obligatorily scoping over the universal quantifier. I don't see how this sentence is relevant in the context of the present discussion. The claim here is that a quantifier in object position cannot scope over the quantifier in subject position. The fact a direct object takes scope over an indirect object in a ditransitive construction tells us nothing about the unavailability of inverse scope in (38). I have never claimed the A/A' position accounts for all the scope-rigid readings of the language.

A: *[A'] feature checking movement feeding [A'] feature checking movement. Cf. Rizzi's (2006,2007) Criterial Freezing.¹⁰

B: *[A] feature checking movement feeding [A'] feature checking movement. Cf. *who left?* effect: *wh*-subject movement cannot proceed through Spec,TP (Bošković 2019, Messick 2020).¹¹

We also do not expect *C* or *D*:

C: *[A] feature checking movement feeding [A] feature checking movement. Cf. Chomsky's (2000,2001) Activation Condition.

D: *[A'] feature checking movement feeding [A] feature checking movement; i.e., improper movement.¹²

I therefore propose (41):

(41) No freezing effect is expected where the A/A' projection is involved, since in this case we don't have A, B, C, or D.

With this approach, hyper-raising is a side effect of subjects occupying Spec,A/A'P, a position where licensing of both A and A'-features are possible. The mixed A/A' position is then the escape hatch needed to void freezing effects. The derivation of the HR sentence *Os meninos parecem que comeram maçã* (cf. 32) is given below.

(42) [CP [A/AP *Os meninos*]_i [TP *parecem* [_{vP} *t_i* [CP *que* [A/AP *t_i* [TP *comeram* [_{vP} *t_i* *maçã* ...

The A/A' projection is always involved in the derivation above: the subject DP moves from Spec,_{vP} to Spec,A/A'P in the embedded clause. Then, it moves to the matrix Spec,_{vP}, and finally to matrix Spec,A/A'P. Therefore, in this approach HR is a side effect of regular subjects occupying Spec,A/A'P.

8. Conclusion

In this paper I have argued that the availability of hyper-raising in Brazilian Portuguese is associated with its subject occupying Spec,A/A'P, a mixed A/A' position between CP and TP in the left periphery of clause structure dedicated to locally moved subjects, thus accounting for the mixed A/A' properties of Brazilian Portuguese subjects. I have also claimed that the freezing effect of feature-checking is voided only when A/A' movement is involved.

¹⁰No A'-movement (e.g., *wh*-movement, topicalization, focalization, QR, NPI-licensing) can feed another instance of A'-movement.

¹¹This approach also captures Chomsky's Activation Condition if interpreted as [A] feature checking movement feeding [A] feature checking movement.

¹² No Spec,TP to Spec,CP movement in *who left?*. Also, in Kinande, objects agree with the verb only when there is no *wh*-movement of the object. So, it is not possible to do object shift (i.e., movement to Spec,_{vP}) followed by *wh*-movement (i.e., movement to Spec,CP), given *D* (Bošković, p.c.).

References

- Alexiadou, A., & Anagnostopoulou, E. 1998. Parametrizing AGR: Word order, V-movement and EPP-checking. *Natural Language & Linguistic Theory*, 16(3), 491-539.
- Altinok, D. 2017. Quantifier Scopepe and Prosody in Turkish (Doctoral dissertation, The University of Utah).
- Amaechi, M. & Georgi, D. 2019. Quirks of subject (non-)extraction in Igbo. *Glossa* 4:1-36.
- Baker, M. C. 2003. Agreement, dislocation, and partial configurability. In *Formal approaches to function in grammar*, ed. by Andrew Carnie, Heidi Harley, and Mary Ann Willie, 107-134. Amsterdam: John Benjamins.
- Baltazani, M. 2002. Quantifier scopepe and the role of intonation in Greek. University of California, Los Angeles.
- Borise, L., & Polinsky, M. 2018. Focus without movement: syntax-prosody interface in Georgian. In *Proceedings of North-East Linguistic Society (NELS) (Vol. 48)*.
- Bošković, Ž. 2008. On successive cyclic movement and the freezing effect of feature checking. In *Sounds of silence: Empty elements in syntax and phonology*, 195-233.
- Bošković, Ž. 2016. On the timing of labeling: Deducing Comp-trace effects, the Subject Condition, the Adjunct Condition, and tucking in from labeling. *The Linguistic Review*, 33(1), 17-66.
- Bošković, Ž. 2019. Generalized asymmetry. Ms., University of Connecticut, Storrs.
- Bošković, Z. (in press) The Comp-trace effect and the contextuality of the EPP. To appear in *Proceedings of WCCFL 39*.
- Bošković, Z. 2021 Merge, Move, and Contextuality of Syntax: The Role of Labeling, Successive-Cyclicity, and EPP Effects. Ms., University of Connecticut.
- Bošković, Z. 2022. On Wh and Subject Positions and the EPP [Conference presentation]. GLOW in Asia XIII, The Chinese University of Hong Kong, August 4-7, Hong Kong, China.
- Chomsky, N. 1981. *Lectures on Government and Binding*. Dordrecht: Foris.
- Chomsky, N. 1986. *Barriers (Vol. 13)*. MIT Press (MA).
- Chomsky, N. 2000. Minimalist inquiries: the framework. In *Step by step: essays on minimalist syntax in honour of Howard Lasnik (R. Martin, D. Michaels & J. Uriagereka, editors)*, pp.81-155. Cambridge, Mass.: The MIT Press.
- Chomsky, N. 2001. Derivation by phase. In *Ken Hale: A Life in language (M. Kenstowicz, editor)*, pp.1-52. Cambridge, Mass.: The MIT Press.
- den Dikken, M. 2017. Predication in the syntax of hyperraising and copy raising. *Acta Linguistica Academica*, 64(1), 3-43.
- Duarte, M. E. L. 1996. A perda do princípio "evite pronome" no português brasileiro. *Sínteses-ISSN 1981-1314*, 1.
- Fernández-Salgueiro, G. 2005. Agree, the EPP-F and further-raising in Spanish. *Amsterdam studies in the theory and history of linguistic science series 4*, 272, 97.
- Ferreira, M. 2000. Argumentos nulos em português brasileiro. [Null arguments in Brazilian Portuguese] M.A. thesis, Universidade Estadual de Campinas.
- Ferreira, M. 2004. Hyperraising and null subjects in Brazilian Portuguese. *MIT Working Papers in Linguistics 47: Collected Papers on Romance Syntax*, 57-85.
- Ferreira, M. 2009. Null subjects and finite control in Brazilian Portuguese. In *Minimalist Essays on Brazilian Portuguese Syntax (J. Nunes, editor)*. Amsterdam: John Benjamins.
- Fong, S. 2018. Featural definition of syntactic positions: Evidence from hyper-raising. *Proceedings of the Linguistic Society of America*, 3(1), 2-1.

- Fong, S. 2019. Proper movement through Spec-CP: An argument from hyperraising in Mongolian. *Glossa: a journal of general linguistics*, 4(1).
- Harley, H., & Noyer, R. 1999. Distributed morphology. *Glott international*, 4(4), 3-9.
- Hoji, H. 1985. *Logical Form Constraints and Configurational Structures in Japanese*. PhD dissertation. Seattle: University of Washington.
- Huang, C-T. J. 1998. *Logical relation in Chinese and the theory of grammar*. (Doctoral dissertation, Massachusetts Institute of Technology).
- Jake, J., & Odden, D. 1979. Raising in kipsigis. *Studies in the Linguistic Sciences*, 9(2), 131-155.
- Kim, L. 2008. *The ditransitive construction in Korean* (Doctoral dissertation, Dept. of Linguistics-Simon Fraser University).
- Kiss, K. E. 2002. *The Syntax of Hungarian*. Cambridge: Cambridge University Press.
- Lacerda, R. 2020. *Middle-field syntax and information structure in Brazilian Portuguese*. (Doctoral dissertation, University of Connecticut).
- Lasnik, H., & Saito, M. 1994. *Move alpha: Conditions on its application and output* (No. 22). MIT press.
- Lobeck, A. C. 1995. *Ellipsis: Functional heads, licensing, and identification*. Oxford University Press on Demand.
- Lohninger, M.; Kovač, I. & Wurmbrand, S. 2022. From Prolepsis to Hyperraising. *Philosophies*, 7, 32. <https://doi.org/10.3390/philosophies7020032>.
- Martins, A. M., & Nunes, J. 2010. Apparent hyper-raising in Brazilian Portuguese: Agreement with topics across a finite CP. The complementizer phase: Subjects and wh-dependencies, 142-163.
- Messick, T. 2020. The derivation of highest subject questions and the nature of the EPP. *Glossa: a journal of general linguistics*, 5(1).
- Mizuguchi, M. 2014. Phases, labeling and wh-movement of the subject. *English Linguistic Society of Japan* 32.
- Montalbetti, Mario M. 1984. *After binding: On the interpretation of pronouns*. PhD thesis. Massachusetts Institute of Technology.
- Nunes, J. 2008. Inherent case as a licensing condition for A-movement: The case of hyper-raising construction in Brazilian Portuguese. In *Journal of Portuguese Linguistics*, 7(2), 83-108.
- Nunes, J. 2020. Especificação morfológica de pronomes nominativos, concordância verbal e sujeitos nulos em português brasileiro. *Fórum Linguístico*, 17(1), 4658-4672.
- Pires, A., & Nediger, W. 2018. (Hyper)-raising in Brazilian Portuguese and Spanish: Interaction between case and agreement. In *Complement Clauses in Portuguese* (pp. 187-212). John Benjamins.
- Rodrigues, C. 2002. Morphology and null subjects in Brazilian Portuguese. In *Syntactic Effects of Morphological Change* (D. Lightfoot, editor), pp. 160-178. Oxford: Oxford University Press.
- Rodrigues, C. 2004. *Impoverished morphology and A-movement out of Case domains*. PhD dissertation, University of Maryland at College Park.
- Rizzi, Luigi. 2006. On the Form of Chains: Criterial Positions and ECP Effects. In L. Cheng & N. Corver (eds.), *Wh-Movement: Moving on*. Cambridge, MA: MIT Press, 97-133.
- Rizzi, Luigi. 2007. On Some Properties of Criterial Freezing. *CISCL Working Papers on Language and Cognition* 1: 145-158.

- Sarma, V. 2003. Noncanonical word order: Topic and focus in adult and child Tamil. *Word order and scrambling*, 238-72.
- Sauerland, U. 1995. *The Late Insertion of Germanic inflection*. Manuscript, Cambridge, Mass.: MIT.
- Shafiei, N. & Storoshenko, D. R. 2017. Scope as a Diagnostic for the Position of Negation in Persian, *University of Pennsylvania Working Papers in Linguistics: Vol. 23 : Iss. 1*, Article 27.
- Wurmbbrand, S. 2019a. Cross-clausal A-dependencies. In *Proceedings of the Fifty-Fourth Annual Meeting of the Chicago Linguistic Society (CLS54)*, ed. by Eszter Ronai, Laura Stigliano and Yen-an Sun, 585-604. Chicago: University of Chicago, Chicago Linguistic Society.
- Wurmbbrand, S. 2019b. Phases in cross-clausal A-dependencies. Talk given at *Rethinking Comparative Syntax, CamCoS8*, Cambridge, UK.
- Tim Chou, C. T., & Hettiarachchi, S. 2016. On Sinhala subject case marking and A-movement. *Lingua*, 177, 17-40.
- Ura, H. 1994. Varieties of raising and the feature-based bare phrase structure theory (No. 7). *MIT Working Papers in Linguistics*.
- Zimmermann, M. 2003. Pluractionality and complex quantifier formation. *Natural Language Semantics*, 11(3), 249-287.

Pseudo-incorporation vs. Differential Argument Marking in Korean*

Imke Driemel, Hyunjung Lee

Humboldt-Universität zu Berlin, Universität Leipzig

1. Introduction

A language displaying optional case marking accompanied by semantic effects is often analyzed either as *pseudo-noun incorporation* (PNI) or as *differential object marking* (DOM), thereby raising the question whether both phenomena represent two sides of the same coin. PNI captures the absence of a case marker, which is roughly explained by the nominal forming a ‘closer-than-usual’ relation with the verb (Massam 2001). DOM, on the other hand, focuses on the presence of the case marker, where its addition signals more discourse prominence relative to other noun types (Bossong 1991; Aissen 2003). Usually, case drop only affects the least prominent noun type in PNI/DOM languages, illustrated here with Mongolian in (1), where only non-specific indefinite objects allow accusative case drop (1c).

(1) *Mongolian* (*Guntsetseg 2016*)

- a. Bi **tuun*(-ig) /Tuya*(-g)** /**ene uul*(-ig)** har-san.
 1SG.NOM 3.ACC /Tuya-ACC /this mountain-ACC see-PST
 ‘I saw her/Tuya/this mountain.’
- b. Delxij **nar*(-yg)** tojr-dog.
 earth.NOM sun-ACC circle-HAB
 ‘The earth circles around the sun.’
- c. Xen neg n minij zugluulgan-aas **neg nom*(-yg)/nom(-yg)** xulgajl-žee
 someone.NOM my collection-ABL a book-ACC/book-ACC steal-PST
 ‘Someone stole a specific book / a non-specific book from my collection.’

The prominence effects are often modeled with prominence scales such as the definiteness scale in (2), where noun types are ranked based on their discourse prominence potential, and case marking becomes more likely the higher the noun is ranked on the scale. For Mongolian and many other languages, the cut-off point for case marking is very low.

(2) *Definiteness scale* (*Silverstein 1976; Aissen 1999, 2003*)

| |
|---------------------------------------------------------------------------------------------------------------------------------------------------------------------------------------------------------------------------------------------------------|
| PRONOUN > PROPER NAME > DEF > DEM > INDEF SPEC > INDEF NON-SPEC |
| <div style="display: flex; justify-content: space-between; align-items: center;"> CASE <<< >>> NO CASE </div> |

Previous corpus work on optional case marking of Korean arguments (H. Lee 2006, 2008; Kwon and Zribi-Hertz 2006, 2008) has identified challenges to an analysis in terms of markedness scales (Aissen 2003).¹ While case loss on indefinite bare nouns displays

* We thank Gereon Müller and the audience at GLOW in Asia XIII, Oda Hiromune, Myung-Kwan Park and Takashi Toyoshima for their valuable feedback.

¹ Park (2020) argues that optional nominative case marking in Korean plays multiple roles to denote contextually prominent referents, i.e., anaphoric definites and unique definites construal.

interpretive effects familiar to PNI, more prominent categories scoring higher on the definiteness scale can also undergo case loss with no such effects. In this paper, we will provide a detailed case study based on scope, binding and control tests, showing that lack of case-marking is indicative but does not entail PNI in Korean. The data, however, can still be captured with an Aissen-style markedness scale, if the scale differentiates between DPs and NPs. Thus, a scale-based account can be naturally combined with a DP/NP account of PNI, where NPs constitute the lowest member of the definiteness scale (see also von Heusinger 2008). We conclude from the results that PNI and DOM are separate phenomena: whereas PNI relates case loss to a size difference and thus triggers semantic effects, DOM simply relates case loss to the position on the definiteness scale.

2. Optional case marking in Korean

In Korean, subjects and objects show optional case marking, shown in (3).² Due to space, we will mostly illustrate the semantic properties for only one argument type per diagnostic.

- (3) a. Ecey Minswu-ka **chinkwu(-lul)** man-nass-ta. (*Ha. Lee 2011*)
 yesterday Minsoo-NOM friend-ACC meet- \PST-DECL
 ‘Minsoo met (his) friend yesterday.’
 b. **Beoseu(-ga)** o-goiss-da. (*Kwon and Zribi-Hertz 2008*)
 bus-NOM come-PROG-DECL
 ‘There’s a/the bus coming.’

What is striking about the Korean case pattern is that significantly more noun types than usual can be affected by case drop, as can be seen in (4).

- (4) a. **Ku??(-ka)/Kunye??(-ka)** wus-ess-e. *3rd pronoun*
 he-NOM/she-NOM laugh-PST-INT
 ‘She/he laughed.’
 b. ...Na-nun **yeca*(-lul)** kuly-ess-e. (*anaphoric*) *definite*³
 I-top woman-ACC paint-PST-INT
 ‘(Context: I met a woman yesterday) ... I painted the woman.’
 c. Yusu-ka **i/ce** **kkoch(-ul)** sa-ss-e. *demonstrative*
 Yusu-NOM this/that flower-ACC buy-PST-INT
 ‘Yusu bought this/that flower.’
 d. Yusu-NOM **kkoch(-ul)** **twu-songi** sa-ss-e. *numeral classifier*
 Yusu-NOM flower-ACC two-CL buy-PST-INT
 ‘Yusu bought two flowers.’
 e. Minho-ka **chayk(-ul)** ilk-nun-ta. *indefinite*
 Minho-NOM book-ACC read-PRS-DECL
 ‘Minho is reading a book (specific or non-specific).’

² Turkish is another language, which has been reported to show differential case marking for both external and internal arguments (Öztürk 2009).

³ Kim (2021) proposes a cartography-cum-optimality approach to account for two forms of anaphoric definites in Korean by encoding sequence of events they are narrating on the relevant Point-of-view licensing head.

Based on the data set in (4), the definiteness scale in Korean can be set up as in (5).⁴ Note that the cut-off point for case marking is much higher in (5) than in (2).⁵

(5) *Definiteness scale in Korean*

| |
|------------------------------------------------------------------|
| (3RD) PRONOUN > DEF > DEM > NUM-CL > INDEF SPEC > INDEF NON-SPEC |
| CASE ←← ⇒⇒ NO CASE |

Since there is more than one noun type which can show optional case marking, Korean provides a good case study to test, whether case loss always correlates with semantic effects. We investigate demonstrative phrases, numeral classifier phrases, and indefinites wrt. established PNI/DOM diagnostics: (i) case loss correlating with obligatory low scope, (ii) case loss correlating with lack of binding, and (iii) case loss correlating with lack of control. Our investigation reveals that only indefinites show a correlation between case marking and semantic properties.

2.1 Scope

The correlation of non-case marked arguments and obligatory low scope readings is well investigated in the PNI/DOM literature, shown e.g., for Spanish (López 2012), Turkish (Kelepir 2001), Kannada (Lidz 2006), Hindi (Dayal 2011), among many others. Contexts (6) and (7) test this prediction for Korean indefinites. Indeed, indefinites cannot receive a wide scope reading wrt. negation, if they are not marked for case, see (7b).

(6) *Context* ¬∃:

Yusu's friend was selling flowers. Yusu looked at all of them but decided not to buy any.

- a. **Kkoch-ul** Yusu-ka ___1 sa-ci anh-ass-ta.
 flower-ACC Yusu-NOM buy-CI NEG-PST-DECL
 ‘Yusu did not buy a flower.’
- b. **Kkoch** Yusu-ka ___1 sa-ci anh-ass-ta.
 flower Yusu-NOM buy-CI NEG-PST-DECL
 ‘Yusu did not buy a flower.’

(7) *Context* ∃¬:

Yusu's friend had only a few flowers left to sell and he wants to sell everything by the end of the day. Yusu decided to buy some of them but not all. So there was at least one flower he did not buy.

- a. **Kkoch-ul** Yusu-ka ___1 sa-ci anh-ass-ta.
 flower-ACC Yusu-NOM buy-CI NEG-PST-DECL
 ‘Yusu did not buy a flower.’
- b. #**Kkoch** Yusu-ka ___1 sa-ci anh-ass-ta.
 flower Yusu-NOM buy-CI NEG-PST-DECL
 ‘Yusu did not buy a flower.’

⁴ Potential independent evidence for the order of scale mates, specifically DEF > DEM > NUM-CL, comes from the observation that classifiers and demonstratives often develop into definite determiners over time (See Diessel 1999 and references therein).

⁵ We distinguish epistemic specificity from scopal specificity since Korean case marking does not show sensitivity to the former but to the latter. Scope effects will be shown in the next section.

In contrast, case marking on numeral classifiers is not sensitive to wide scope contexts, shown for objects in (8) and subjects in (9).

(8) Context 1↯:

Yusu's friend wanted to sell three flowers and Yusu bought two from him. So there was one flower Yusu did not buy.

- a. [**Kkoch-ul han-songi**]₁ Yusu-ka ___₁ sa-ci anh-ass-ta.
 flower-ACC one-CL Yusu-NOM buy-CI NEG-PST-DECL
 'One flower, Yusu did not buy.'
- b. [**Kkoch han-songi**] Yusu-ka ___₁ sa-ci anh-ass-ta.
 flower one-CL Yusu-NOM buy-CI NEG-PST-DECL
 'One flower, Yusu did not buy.'

(9) Context 1↯:

Suzi was waiting at Mapo bus stop. On the other side, there were three buses waiting for the signal. As soon as the traffic light turned green, two buses came straight to the stop where Suzi was standing.

- a. [**Pesu-ka han-tay**]₁ nollapkeyto ___₁ o-ci anh-ass-ta.
 bus- NOM one- CL to my surprise come- CI NEG-PST-DECL
 'One bus, did not come.'
- b. [**Pesu han-tay**]₁ nollapkeyto ___₁ o-ci anh-ass-ta.
 bus one- CL to my surprise come- CI NEG-PST-DECL
 'One bus, did not come.'

2.2 Binding and Control

Two more diagnostics are frequently applied in the PNI/DOM literature. Non-case marked arguments cannot bind a pronoun, nor can they control into a control clause. This has been shown for at least Hindi (Bhatt 2007), Spanish (Leonetti 2004; López 2012), and Turkish (Öztürk 2009). In (10), we create a binding configuration involving a Korean reflexive which needs to be bound by the indefinite subject. As expected, only the case-marked indefinite can do so.

- (10) a. **Koyangi-ka**₁ [ku casin-ul]₁ halth-ass-e.
 cat- NOM 3SG self-ACC lick-PST-INT
 'A cat washed itself.'
- b. ***Koyangi**₁ [ku casin-ul]₁ halth-ass-e.
 cat 3SG self-ACC lick-PST-INT
 'A cat washed itself.'

Parallel binding configurations, however, where the binder constitutes a demonstrative phrase (11) or a numeral classifier (12) display no sensitivity to case marking.

- (11) a. [**I koyangi(-ka)**]₁ [ku casin-ul]₁ halth-ass-e.
 DEM cat-NOM 3SG self-ACC lick-PST-INT
 'This cat washed itself.'

- b. [**Ce koyangi(-ka)**]₁ [ku casin-ul]₁ halth-ass-e.
 DEM cat-NOM 3SG self-ACC lick-PST-INT
 ‘That cat washed itself.’
- (12) a. [**Koyangi(-ka) han-mali**]₁ [ku casin-ul]₁ halth-ass-e.
 cat-NOM one-CL 3SG self-ACC lick-PST-INT
 ‘One cat washed itself.’
- a. [**Koyangi(-ka) twu-mali**]₁ [ku casin-ul]₁ halth-ass-e.
 cat-NOM two-CL 3SG self-ACC lick-PST-INT
 ‘Two cats washed themselves.’

In line with (10), Korean indefinites without case marking cannot control into a complement clause, shown here for subject (13) and object control (14).

- (13) a. **Haksayng-i**₁ [PRO₁ ttena-keyss-ta-ko] kyelsimhay-ss-e.
 student-NOM leave-VOL-DECL-COMP decide-PST-INT
 ‘A student decided to leave.’
- b. ***Haksayng**₁ [PRO₁ ttena-keyss-ta-ko] kyelsimhay-ss-e.
 student leave-VOL-DECL-COMP decide-PST-INT
 ‘A student decided to leave.’
- (14) a. Yusu-ka **haksayng-ul**₁ [PRO₁ ttena-la-ko] seltukhay-ss-e.
 Yusu-NOM student-ACC leave-IMP-COMP persuade-PST-INT
 ‘Yusu persuaded a student to leave.’
- b. *Yusu-ka **haksayng**₁ [PRO₁ ttena-la-ko] seltukhay-ss-e.
 Yusu-NOM student leave-IMP-COMP persuade-PST-INT
 ‘Yusu persuaded a student to leave.’

For demonstrative phrases and numeral classifiers, however, no such interactions are found.

- (15) [**I/ce haksayng(-i)**]₁ [PRO₁ ttena-keyss-ta-ko] kyelsimhay-ss-e.
 DEM student-NOM leave-VOL-DECL-COMP decide-PST-INT
 ‘This student decided to leave.’
- (16) [**Haksayng(-i) han-myeng**]₁ [PRO₁ ttena-keyss-ta-ko] kyelsimhay-ss-e.
 student-NOM one-CL leave-VOL-DECL-COMP decide-PST-INT
 ‘One student decided to leave.’
- (17) [**Haksayng(-i) twu-myeng**]₁ [PRO₁ ttena-keyss-ta-ko] kyelsimhay-ss-e.
 student-NOM two-CL leave-VOL-DECL-COMP decide-PST-INT
 ‘Two students decided to leave.’

In the remainder of the paper, we will argue for two conclusions. One can draw from the Korean data set. First, DP/NP approaches can account for the data set, in contrast to raising accounts. Second, a post-syntactic case marking approach based on prominence scales is needed to

account for the full set of data, as a syntactic case licensing account makes the wrong predictions.

3. Raising analyses

Raising accounts of DOM model the interaction of case marking and low scope via *object shift*, which is illustrated in (18). The raised position has been taken to be the locus of case assignment (Torrego Salcedo 1999; Öztürk 2009; Dobrovie-Sorin et al. 2006; Rodríguez-Mondoñedo 2007; López 2012), the escape of existential closure (Diesing 1992; Kelepir 2001), or both (Bhatt 2007; Bhatt and Anagnostopoulou 1996). Consequently, objects that do not raise to receive obligatory low scope and do not get assigned case.

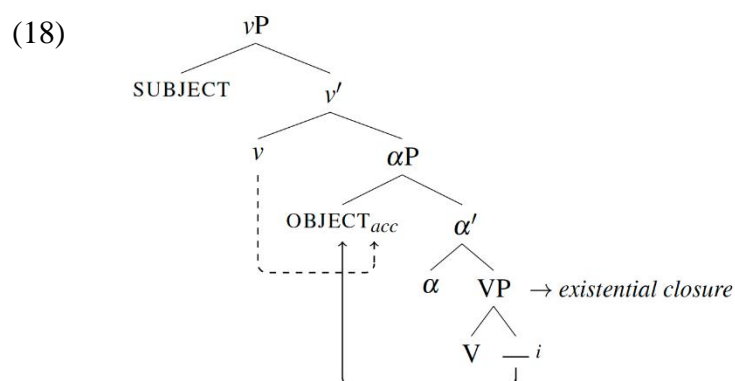

The binding and control properties are rarely addressed in the raising literature. Some accounts propose to derive these effects from the landing site of the case-marked object (Bhatt 2007; López 2012). The binding data include double object constructions where the bindee is the indirect object, as shown in (19). The argument can be transferred to adjunct control, where the control clause is possibly attached in a position similar to where the pronoun is merged in (19).

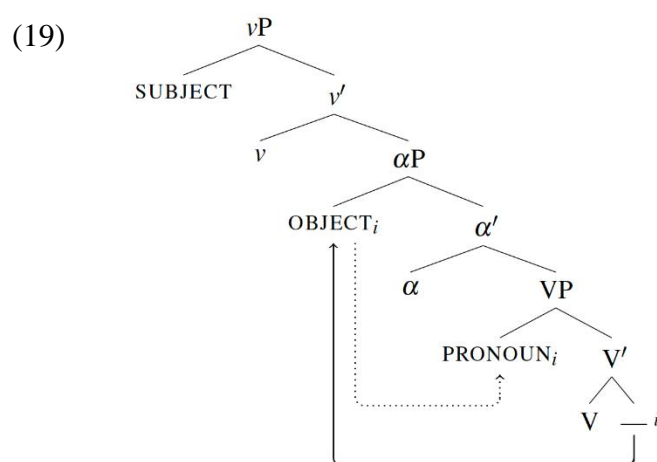

Crucially, none of the binding and control data we have presented in the previous section can be captured with the rationale of the raising account. The indefinite subject which lacks case-marking in (10b) is arguably first-merged in a position where it c-commands the reflexive pronoun. Moreover, the control data in (13)-(14) include complement control clauses, where

the controller is presumably first-merged in a position where it can c-command into the control clause. Hence, no movement is necessary and no interactions with case marking are expected.

Even if there was a way to tie the binding and control data to a movement operation, we would still have to explain why for a subset of noun types, i.e., numeral classifiers and demonstratives, this movement operation is not necessary to become a binder/controller.

4. DP/NP approaches

Size based approaches to PNI/DOM capitalize on the assumption that smaller arguments like NPs do not need case (Massam 2001; Dayal 2011; Barrie and Li 2015), whereas DPs need case. One immediate benefit of this account is that the syntactic size can be related to different semantic objects. DPs can be of type e or $\langle e,t \rangle$, which enables them to take flexible scope. NPs, however, are properties, they don't take scope, which in turn leads to a compositionality problem with the verb. One prominent way to resolve this issue is to assume additional incorporation denotations for V/v (van Geenhoven 1998; Dayal 2011; Jo and Palaz 2019), which select for $\langle e,t \rangle$ -type arguments and where the variable that the PNI-ed noun predicates over is existentially closed off inside the verb denotation, thereby ensuring obligatory low scope.⁶ A simple illustration of this idea is given in (20), based on the scope configuration in (7). In (7a), the indefinite object is a case-marked DP and can combine with the standard verb denotation for *saci*, either directly as a choice function or as an existential quantifier via QR, which opens up the possibility for a wide scope existential interpretation. In (7b) though, the indefinite object is a non-case marked NP which denotes a property and thus combines with *saci_{inc}*, which leaves no room for the negative operator to take scope below the existential.

- (20) a. $\llbracket \text{saci} \rrbracket = \lambda y_e \lambda x [\text{BUY}(x,y)]$ (7a)
 b. $\llbracket \text{saci}_{inc} \rrbracket = \lambda P_{\langle e,t \rangle} \lambda x \exists y [\text{BUY}(x,y) \wedge P(y)]$ (7b)
 c. $\llbracket (7b) \rrbracket = \neg \exists y [\text{BUY}(yusu,y) \wedge \text{FLOWER}(y)]$

The binding and control properties are not addressed in the DP/NP literature. There is, however, a promising way to derive them from the $\langle e,t \rangle$ -denotation of NPs. In (21) and (22), we provide the LFs for the binding configurations in (10). Following Heim and Kratzer (1998), binding requires movement of the binder, which subsequently binds its trace and every pronoun co-indexed with it. We believe that the LF in (22) is blocked for independent reasons, thus resulting in the unacceptability of (10b).

- (21) a. **Koyangi-ka**₁ [ku casin-ul]₁ halth-ass-e. (*repeated from (10a)*)
 b. DP₁ $\lambda f_e \dots$ [*trace_e*]₁ ... [*pronoun_e*]₁
 (22) a. * **Koyangi**₁ [ku casin-ul]₁ halth-ass-e. (*repeated from (10b)*)
 b. NP₁ $\lambda f_{\langle e,t \rangle} \dots$ [*trace_{\langle e,t \rangle}*]₁ ... [*pronoun_{\langle e,t \rangle}*]₁

Recently, Poole (2017, 2018) has argued that there are no higher type traces, based on a number of constructions involving property-type arguments which can only undergo movement operations that obligatorily reconstruct. This ban on higher type traces is formulated in (23).

⁶ Other ways to resolve the compositionality problem is by adopting a new compositional mode to combine predicates and verbs (Chung and Ladusaw 2004) or by assuming a type-shifting determiner on PNI-ed nouns (Driemel 2020a, b).

Given that the LFs in (21) and (22) require scope-shift movement, (22b) is blocked by the TIC. Consequently, if NPs denote properties, they cannot act as binders.

- (23) TRACE INTERPRETATION CONSTRAINT (TIC) (Poole 2018: 217)
 *[XP₁ [λf_{σ} [... [f_{σ}]₁ ...]]], where σ is not an individual type

The control facts follow without further ado, if we assume that for a control relation to be established the control argument has to bind PRO (Chomsky 1981; Manzini 1983; Landau 2015).

- (24) a. Yusu-ka **haksayng-ul**₁ [PRO₁ ttena-la-ko] seltukhay-ss-e. *(repeated from (14a))*
 b. ... DP₁ λf_e ... [$trace_e$]₁ ... [[PRO_e]₁ ...] ...
- (25) a. *Yusu-ka **haksayng**₁ [PRO₁ ttena-la-ko] seltukhay-ss-e. *(repeated from (14b))*
 b. ... NP₁ $\lambda f_{\langle e,t \rangle}$... [$trace_{\langle e,t \rangle}$]₁ ... [[PRO_{\langle e,t \rangle}]₁ ...] ...

Now that we have developed a DP/NP account covering all semantic interactions with case loss, we come back to the Korean data set. Note that attributing the loss of case marking to the NP status will not suffice, as demonstratives and numeral classifiers do not have to be case marked to take wide scope and/or undergo binding or control. Hence, we propose to combine the DP/NP account with the rationale of a definiteness scale, shown in (26), where NPs instantiate the lowest scale mates and all other scale mates are syntactically bigger than an NP.

(26) *Definiteness scale in Korean*

| | | | | | | | | | | | |
|---------------|---|-----|---|----------|---|-----|---|---------------|-----------|-----------------------------------------|--|
| (3RD) PRONOUN | > | DEF | > | DP-INDEF | > | DEM | > | NUM-CL | > | NP-INDEF _{\langle e,t \rangle} | |
| | | | | CASE ← | | | | OPTIONAL CASE | ⇒ NO CASE | | |

The semantic effects (scope/binding/control) for indefinites derive from the size difference: NPs denote properties. NP indefinites are also never marked for case since they constitute the lowest member of the definites scale. Finally, the scale-based approach has to leave open the possibility for a set of noun types which are optionally marked for case.

5. Case-marking in syntax

How and in which module do we implement the definiteness scale? Kalin (2018) proposes that prominence scales can be translated into privative nominal projections (see also Tyler 2019; Levin 2019). A definite argument e.g., is different from an indefinite specific argument by containing one more nominal projection layer (27). The number of projections increases, the higher the noun type is ranked on the prominence scale.

- (27) *definite*: [_{DefP} Def [_{SpecP} Spec NP]] vs. *specific indefinite*: [_{SpecP} Spec NP]

Kalin assumes that an uninterpretable case feature [$uCASE:\bullet$] must be licensed via AGREE, in contrast to an interpretable case feature [$CASE:\bullet$] and languages vary as to which nominal projection introduces [$uCASE:\bullet$]. The result of AGREE can be detected as agreement morphology on the verb and/or case morphology on the noun. In order to derive the case properties of Korean indefinites, we have to assume that case marked indefinites constitute

SpecPs, where the Spec head comes with an uninterpretable case feature that needs to be licensed (28), while non-case marked indefinites constitute NPs with an interpretable case feature that does not have to be licensed (29).

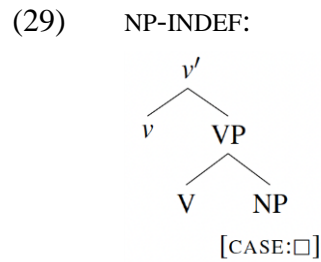
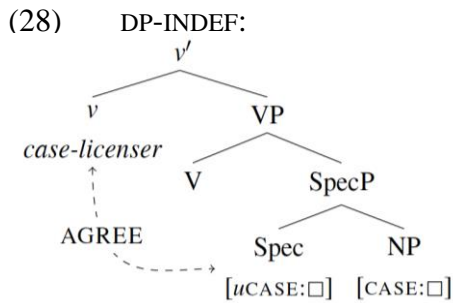

One problem we encounter with this approach is that Kalin’s system does not *per se* predict noun types to exist that show optional case marking. Given the privative nature of the nominal projections, we expect a one-to-one mapping of a scale mate with the presence/absence of a morphological marker. Hence, we are forced to enrich Kalin’s account with the assumption that some nominal layers can introduce both [μ CASE:•] and [CASE:•], illustrated for Korean demonstratives in (30) and (31).

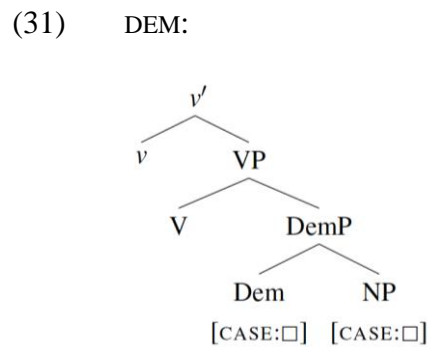
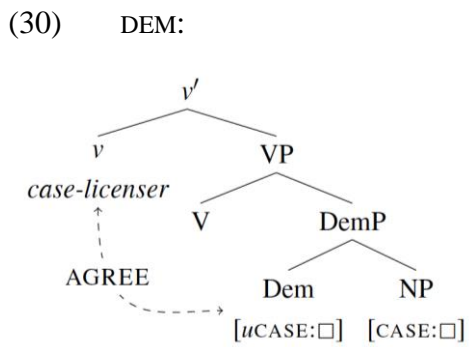

The second, potentially more severe, problem concerns the prediction that differential case marking interacts with other AGREE-related operations. As is shown in (32), this prediction is not borne out in Korean. Korean displays honorific agreement (e.g. Choi and Harley 2019) as well as honorific differential case marking. Kalin’s theory predicts that without the honorific case marker there should be no honorific agreement marker either, as the AGREE operation has not taken place. Case marking, however, is independent of agreement, as shown in (32).

- (32) Halapeci(-kkeyse) cenyek-ul capswu-si-n-ta.
 grandfather-HON.NOM dinner-ACC eat-HON-PRS-DECL
 ‘Grandfather is having dinner.’

We conclude that the case licensing account is not tenable in light of the Korean data. The next section will explore a different proposal how to implement prominence scales.

6. Case-marking in post-syntax

Another way to derive the effects of a prominence scale like (26) is to translate the scale into an OT-ranking (Aissen 1999, 2003), which regulates the realization of case features based on economy and iconicity pressures. We will entertain the post-syntactic version of this OT-account (Keine and Müller 2011, 2015) since the absence of case marking does not seem to interact with other syntactic operations. We propose that the only size difference relevant in this system is the one between NP and DP, where NPs constitute the lowest member of the scale, but DPs can instantiate different nominal types, depending on the feature bundles of the D heads. The scale in (33) is a representation of (26) in terms of feature bundles. Note that only the lowest scale mate lacks a [+D] feature. This is the argument type which is interpreted at LF as a property.

(33) *Definiteness scale in Korean*

$$\begin{array}{ccccccc}
 [3, +D] > [+DEF, +D] > [-DEF, +D] > [+DEM, +D] > [+CL, +D] > [-DEF]_{\langle e, t \rangle} \\
 \text{CASE} \leftarrow & & & \text{OPTIONAL CASE} & & & \Rightarrow \text{NO CASE}
 \end{array}$$

The syntactic features are accessible in post-syntax. They are made reference to via faithfulness constraints, locally conjoined with MAX-C which preserves case marking. The markedness constraint *[-OBL] (captures both nominative and accusative) triggers case deletion and is ranked depending on the cut-off point on the definiteness scale. The constraints for DEM and NUM-CL are not ranked with respect to *[-OBL], hence case marking is optional with them.

(34) *Constraint ranking:*

$$\left\{ \begin{array}{l} * [3, +D] \ \& \ \text{MAX-C} \\ * [+DEF, +D] \ \& \ \text{MAX-C} \\ * [-DEF, +D] \ \& \ \text{MAX-C} \end{array} \right\} \gg \left\{ \begin{array}{l} * [+DEM, +D] \ \& \ \text{MAX-C} \\ * [+CL, +D] \ \& \ \text{MAX-C} \\ * [-OBL] \end{array} \right\} \gg \left\{ * [-DEF] \ \& \ \text{MAX-C} \right\}$$

Every argument type is assigned case in syntax properly. Thus, each input for the OT tableaux will contain a decomposed case feature. The ranking of the constraints, however, decides whether [-OBL], will be realized. Local conjunction produces constraint ties (a tie is not violated if at least one constraint of the tie is satisfied). Thus, a constraint like *[-DEF, +D] & MAX-C expresses that the feature bundle [-DEF, +D] can be realized as long as it is case marked. Since the markedness constraint *[-OBL] is ranked lower, DP-INDEF will always be case marked, see (35). By the same rationale, NP-INDEF will never be case marked, as the faithfulness constraint *[-DEF] & MAX-C is ranked lower than *[-OBL], shown in (36).

(35) DP-INDEF case-marked

| [+DEF, +D] [-OBL] | *[+DEF, +D] & MAX-C | *[-DEF, +D] & MAX-C | *[+DEM, +D] & MAX-C | *[+CL, +D] & MAX-C | *[-OBL] | *[-DEF] & MAX-C |
|------------------------------------|---------------------|---------------------|---------------------|--------------------|---------|-----------------|
| a. [+DEF, +D] | | *! | | | | |
| b. \varnothing [+DEF, +D] [-OBL] | | | | | * | |

(36) NP-INDEF not case-marked

| [-DEF] [-OBL] | *[+DEF, +D] & MAX-C | *[-DEF, +D] & MAX-C | *[+DEM, +D] & MAX-C | *[+CL, +D] & MAX-C | *[-OBL] | *[-DEF] & MAX-C |
|------------------|------------------------|------------------------|------------------------|-----------------------|---------|--------------------|
| a. ☞[-DEF] | | | | | | * |
| b. [-DEF] [-OBL] | | | | | *! | |

According to the ranking in (34), the faithfulness constraints for demonstratives and numeral classifiers are not ranked wrt. *[-OBL], indicated in (37) and (38) with dotted lines. This leads to optionality of case marking.

(37) DEM optionally case-marked

| [+DEM,+D] [-OBL] | *[+DEF, +D] & MAX-C | *[-DEF, +D] & MAX-C | *[+DEM, +D] & MAX-C | *[+CL, +D] & MAX-C | *[-OBL] | *[-DEF] & MAX-C |
|----------------------|------------------------|------------------------|------------------------|-----------------------|---------|--------------------|
| a. ☞[+DEM,+D] | | | * | | | |
| b. ☞[+DEM,+D] [-OBL] | | | | | * | |

(38) NUM-CL optionally case-marked

| [+CL,+D] [-OBL] | *[+DEF, +D] & MAX-C | *[-DEF, +D] & MAX-C | *[+DEM, +D] & MAX-C | *[+CL, +D] & MAX-C | *[-OBL] | *[-DEF] & MAX-C |
|---------------------|------------------------|------------------------|------------------------|-----------------------|---------|--------------------|
| a. ☞[+CL,+D] | | | | * | | |
| b. ☞[+CL,+D] [-OBL] | | | | | * | |

This section has shown how post-syntactic case realization guided by scale-based reasoning and a categorial distinction between DP and NP can derive the full set of Korean data.

7. Summary and outlook

In Korean, case marking is optional for a number of noun types. As these noun types rank low on the definiteness scale, the case-marking properties can be identified as differential argument marking. Only a subset of noun types, however, show an interaction of case marking with semantic effects in terms of scope, binding, and control. The semantic effects can be explained by DP/NP accounts, often proposed for the phenomenon of pseudo-incorporation. We have shown that Korean case marking can be modeled via (post-syntactic) realization of case features, regulated by an OT-ranking which maps to the definiteness scale. While the current account is able to capture the differential case marking properties in Korean, there are at least two more aspects of the pattern, we will address in the remainder of the paper.

One property which we have not considered so far is mobility. PNI-ed arguments have been argued to be immobile in languages like Tamil, Sakha, and Mongolian (Baker 2014; Guntsetseg 2016), whereas other languages like Hindi do not show movement restrictions (Dayal 2011), implying that there is considerable cross-linguistic variation. For Korean, we can observe that indefinites without case marking are limited in their movement properties, in the same way that VPs are limited. In fact, there is a connection between VP-movement and PNI-movement across a number of PNI languages (Driemel 2020b). The movement restrictions challenge the DP/NP account proposed in this paper and potentially call for a different account of differential case marking, see Driemel (2020a, b) for discussion.

Finally, let us address the class of noun types we have so far excluded from the discussion. In Korean, weak definite noun phrases, proper names, and local 1st/2nd person pronouns also show optional case marking. For these noun types there seems to be an interaction between case loss and semantic effects. Hence, they pattern with indefinites in Korean, which is somewhat unexpected from a typological perspective. Since there is no space to run through all diagnostics, we will simply present the basic data and sketch a preliminary analysis. We refer the reader to Driemel (2020a) for a complete representation and discussion of the semantic interactions.

In (39), we demonstrate that case marking is optional for local pronouns in subject and object position. The data in (40) shows that this is also true for proper names.

- (39) a. Yusu-ka **na(-lul)/ne(-lul)** manna-ss-e.
 Yusu-NOM I-ACC /you-ACC meet-PST-INT
 ‘Yusu met me/you.’
 b. **Na(-ka)/ne(-ka)** wus-ess-e.
 I-NOM /you-NOM laugh-PST-INT
 ‘I/you laughed.’

- (40) a. Yusu-ka **nwutheylla(-ul)** sa-ss-e.
 Yusu-NOM Nutella-ACC buy-PST-INT
 ‘Yusu bought Nutella.’
 b. **Suzi(-ka)** wus-ess-e.
 Suzi-NOM laugh-PST-INT
 ‘Suzi laughed.’

Recall from Section 2 that case marking is obligatory for 3rd person pronouns and anaphoric definite phrases. One way in which local pronouns and proper names are different from these noun types is that interlocuters immediately agree on the referent in (39) and (40) without the need for a preceding context. In contrast, 3rd pronouns and anaphoric definites require an antecedent to determine their referents. If this is what matters for differential case marking in Korean, we predict that uniqueness based definites should also allow for optional case marking. This is only partially true, as can be seen in (41), where the non-case marked definite *yewang* is only acceptable if it co-occurs with the determiner *ku*.

- (41) a. Na-nun **yewang-ul** eceyspam mannassee.
 I-TOP queen-ACC last.night met
 ‘I met the queen last night.’
 b. ?*Na-nun **yewang** eceyspam mannassee.
 I-TOP queen last.night met
 ‘I met the queen last night.’
 c. ?Na-nun **ku yewang** eceyspam mannassee.
 I-TOP DEF queen last.night met
 ‘I met the queen last night.’

The status of *ku* is often debated (Ch. Lee 1989, 1992, Kang 2015, 2021, Ahn 2017). Sohn (1999: 210) ascribes *ku* the function of a demonstrative which, in contrast to *ce/i*, signals that

the referent is “known to both speaker and hearer”. We believe that the pattern in (41) suggests an analysis of *ku* as the overt spell-out of an ident-type shifter (Partee 1986), which additionally presupposes that interlocutors universally agree on the referent of the singleton set created by the type shifter, see (42).

$$(42) \llbracket ku \rrbracket = \lambda x_e \lambda y_e [x=y],$$

defined iff speaker and hearer can universally agree on x's referent

The type-shifter applies to *yewang* in (41c) to derive the definite reading, while at the same time turning the argument into a property, thereby enabling differential case marking. This proposal presupposes that the type shifter also changes the syntactic category from DP to NP. We can extend this analysis to (39) and (40), albeit with the additional assumption that the ident-type shifter does not always have to be spelled out overtly.

References

- Ahn, Dorothy. 2017. Definite and demonstrative descriptions: A micro-typology. In *Proceedings of GLOW in Asia XI*, ed. by Erlewine, M. Y., 33–48. MIT Working Papers in Linguistics, Cambridge, MA.
- Aissen, Judith. 1999. Markedness and Subject Choice in Optimality Theory. *Natural Language and Linguistic Theory*. 17:673–711
- Aissen, Judith. 2003. Differential Object Marking: Iconicity vs. Economy. *Natural Language and Linguistic Theory*. 21:435–483.
- Baker, Mark. 2014. Pseudo Noun Incorporation as Covert Noun Incorporation: Linearization and Crosslinguistic Variation. *Language and Linguistics*, 15:5–46.
- Barrie, Michael. and Li, Audrey. 2015. The Semantics of (Pseudo) Incorporation and Case. In *The Syntax and Semantics of Pseudo-Incorporation*, ed. by Borik, O. and Gehrke, B., 159–188. Brill, Leiden/Boston.
- Bhatt, Rajesh. 2007. Unaccusativity and case licensing. Talk presented at McGill University.
- Bhatt, Rajesh. and Anagnostopoulou, Elena. 1996. Object shift and specificity: Evidence from *ko-* phrases in Hindi. In *Proceedings of the 32nd Regional Meeting of the Chicago Linguistic Society*, ed. by Dobrin, L., Singer, K., and McNair, L., 11–22. Chicago Linguistic Society, Chicago.
- Bossong, Georg. 1991. Differential Object Marking in Romance and Beyond. In *New Analyses in Romance Linguistics*, ed. by Kibbee, D. A. and Wanner, D., 143–170. John Benjamins, Amsterdam.
- Choi, Jaehoon and Harley, Heidi 2019. Locality domains and morphological rules. *Natural Language and Linguistic Theory*. 37(4):1319–1365.
- Chomsky, Noam. 1981. *Lectures on Government and Binding*. de Gruyter, Berlin.
- Chung, Sandra Ladusaw, A. William. 2004. *Restriction and Saturation*. MIT Press, Cambridge.
- Dayal, Veneeta. 2011. Hindi pseudo-incorporation. *Natural Language and Linguistic Theory*, 29:123–167.
- Diesing, Molly. 1992. *Indefinites*. MIT Press, Cambridge.
- Diessel, Holger. 1999. The morphosyntax of demonstratives in synchrony and diachrony. *Linguistic Typology*, 3:1–49.
- Dobrovie-Sorin, Carmen, Bleam, Tonia and Espinal, M. Teresa. 2006. Bare nouns, number and types of incorporation. In *Non-definiteness and Plurality*, ed. by Voegeleer, S. and Tasmowski, L., 51–79. John Benjamins, Amsterdam/Philadelphia.
- Driemel, Imke. 2020a. Pseudo-incorporation across languages. PhD thesis, Leipzig University.
- Driemel, Imke. 2020b. Pseudo-incorporation and its movement patterns. *Glossa: a journal of general linguistics*. 5:106.
- Van Geenhoven, Veerle. 1998. *Semantic Incorporation and Indefinite Descriptions*. CSLI, Palo Alto.
- Guntsetseg, Dolgor. 2016. *Differential Case Marking in Mongolian*. Harrassowitz Verlag, Wiesbaden.
- Heim, Irene. and Kratzer, Angelika. 1998. *Semantics in Generative Grammar*. Blackwell, Oxford.
- von Heusinger, Klaus. 2008. Verbal semantics and the diachronic development of DOM in Spanish. *Probus*. 20:1–31.

- Jo, Jinwoo. and Palaz, Bilge. 2019. Licensing Pseudo-Noun Incorporation in Turkish. In *Proceedings of the 49th Annual Meeting of the North East Linguistic Society*, ed. by Baird, M. and Pesetsky, J. GLSA, Amherst, MA.
- Kalin, Laura. 2018. Licensing and Differential Object Marking: The View from Neo-Aramaic. *Syntax*. 21:112–159.
- Kang, Arum. 2015. *(In)definiteness, disjunction and anti-specificity in Korean: A study in the semantics-pragmatics interface*. PhD thesis, University of Chicago.
- Kang, Arum. 2021. Marking definiteness in an articleless language: The role of the domain restrictor *ku* in Korean. *Language and Linguistics*, 22(2):302–337.
- Keine, Stefan. and Müller, Gereon. 2011. Non-Zero/Non-Zero Alternations in Differential Object Marking. In *Proceedings of the 39th Annual Meeting of the North East Linguistic Society*, ed. by Lima, S., Mullin, K., and Smith, B., 441–454. GLSA, Amherst.
- Keine, Stefan. and Müller, Gereon. 2015. Differential Argument Encoding by Impoverishment. In *Scales and Hierarchies: A Cross-Disciplinary Perspective*, ed. by Bornkessel-Schlesewsky, I., Malchukov, A., and Richards, M., 75–130. de Gruyter, Berlin.
- Kelepir, Meltem. 2001. Topics in Turkish syntax: Clausal structure and scope. PhD thesis, MIT.
- Kim, Min-Joo. 2021. Apparent Optionality in Marking Anaphoric Definites in Korean. Talk presented at KLCC 2021, Syntax-Semantics-Pragmatics Interface.
- Kwon, Song-Nim and Zribi-Hertz, Anne. 2006. Bare objects in Korean: (Pseudo-)incorporation and (in)definiteness. In *Non-definiteness and Plurality*, ed. by Vogeleer, S. and Tasmowski, L., 107–132. John Benjamins, Amsterdam/Philadelphia.
- Kwon, Song-Nim and Zribi-Hertz, Anne. 2008. Differential Function Marking, Case, and Information Structure: Evidence from Korean. *Language*, 84: 258–299.
- Landau, Idan. 2015. *A Two-Tiered Theory of Control*. MIT Press, Cambridge.
- Lee, Chungmin. 1989. (In)definites, Case Markers, Classifiers and Quantifiers in Korean. In *Harvard Studies in Korean linguistics III*, ed. by Kuno, S., Whitman, J., Kang, Y.-S., Lee, I.-H., Bak, S.-Y., and Kim, Y.-J., 469–487. Hanshin, Seoul.
- Lee, Chungmin. 1992. Definite/specific and case marking in Korean. In *Theoretical issues in Korean linguistics*, ed. by Young-key Kim-Renaud, Y., 325–341. Center for the Study of Language (CSLI) for Stanford Linguistics Society.
- Lee, Hanjung. 2006. Iconicity and variation in the choice of object forms in Korean. *Language Research*. 42: 323–355.
- Lee, Hanjung. 2008. Quantitative Variation in Korean Case Ellipsis: Implications for Case Theory. In *Differential Subject Marking*, ed. by de Hoop, H. and de Swart, P., 41–61. Springer, Dordrecht.
- Lee, Hanjung. 2011. Gradients in Korean case ellipsis: An experimental investigation. *Lingua*. 121(1):20–34.
- Leonetti, Manuel. 2004. Specificity and Differential Object Marking in Spanish. *Catalan Journal of Linguistics*, 3:75–114.
- Levin, Theodore. 2019. On the nature of differential object marking: Insights from Palauan. *Natural Language and Linguist Theory*. 37:167–213.
- Lidz, Jeffrey. 2006. The grammar of accusative case in Kannada. *Language*. 82:10–32.
- López, Luis. 2012. *Indefinite Objects. Scrambling, Choice Functions, and Differential Marking*. The MIT Press, Cambridge, Massachusetts.
- Manzini, Rita. 1983. On Control and Control Theory. *Linguistic Inquiry*. 14:421–446.

- Massam, Diane. 2001. Pseudo noun incorporation in Niuean. *Natural Language and Linguistic Theory*. 19:153–97.
- Öztürk, Balkız. 2009. Incorporating agents. *Lingua*, 119:334–358.
- Park, Myung-Kwan. 2020. Nominative Case Unmarking in Korean. *Studies in Modern Grammar*. 108:1–17.
- Partee, Barbara. 1986. Ambiguous Pseudoclefts with Unambiguous Be. In *Proceedings of NELS 16*, ed. by Berman, S., Choe, J.- W., and McDonough, J., 354–366. University of Massachusetts, Amherst, MA.
- Poole, Ethan. 2017. Movement and the semantic type of traces. PhD thesis, University of Massachusetts, Amherst.
- Poole, Ethan. 2018. Constraining (shifting) types at the interface. In *Proceedings of Sinn und Bedeutung 22*, ed. by Sauerland, U. and Solt, S., 217–234. Berlin. ZAS.
- Rodríguez-Mondoñedo, Miguel. 2007. The syntax of objects: Agree and Differential Object Marking. PhD thesis, University of Connecticut.
- Silverstein, Michael. 1976. Hierarchies of features and ergativity. In *Grammatical categories in Australian Languages*, ed. by Dixon, R. M. W., 112–171. Australian Institute of Aboriginal Studies, Canberra.
- Sohn, Ho-Min. 1999. *The Korean Language*. Cambridge University Press, Cambridge.
- Torrego Salcedo, Esther. 1999. El complemento directo preposicional. In *Gramática descriptiva de la lengua española. Las construcciones sintácticas fundamentales. Relaciones temporales, aceptuales y modales Vol 2*, ed. by Bosque, I. and Demonte, V., 1779–1805. Espasa Calpe, Madrid.
- Tyler, Matthew. 2019. Differential Object Marking by A'-status. In *Proceedings of the 49th Meeting of the North East Linguistics Society*, ed. by Baird, M. and Pesetsky. GLSA Publications, Amherst.

Dissolving Matching*

Shrayana Haldar

Massachusetts Institute of Technology

1. Introduction

This paper concerns relative clauses (henceforth, “RCs”) and their structures.¹ There’s a long tradition in the literature on RCs to posit a distinction between what are known as a Raising and a Matching structure. The following are two representative examples of these two structures (1).

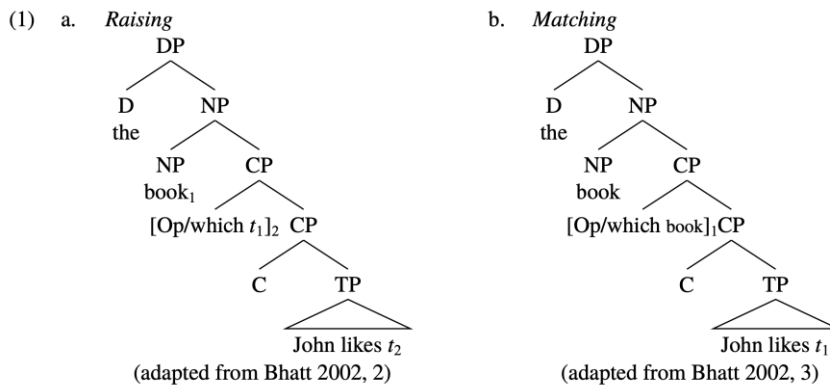

Against this background, I have three principal goals in this paper: (a) present a unified analysis of RCs that does not posit a Raising v. Matching distinction by extending Wholesale Late Merge (henceforth, “WLM”), as presented in Takahashi and Hulsey (2009) (henceforth, “T&H”) and (b) show an existing attempt at such unification (Henderson 2007) is inadequate. The following is the structure of this paper. In §2, I summarize the motivation behind the Raising v. Matching distinction. In §3, I explain why this distinction doesn’t serve us explanatorily, through an exploration of extraposition data. In §4, I show why Henderson’s (2007) account of the data shouldn’t be adopted. In §5, I present my implementation of WLM to substitute for the problematic part of Henderson’s account. In §6, I present Johnson’s (2018) multidominant model of DP Movement within which my account will be couched and how RCs will be derived given this model and my implementation of WLM. In §7, I show how this entire account can derive the extraposition data. §8 concludes the paper.

* The content of this paper was conceived in an email conversation with Kyle Johnson. I’m grateful to him for engaging in the discussion that eventually led to this. I’m also indebted to Amir Anvari, Athulya Aravind, Bronwyn Bjorkman, Rajesh Bhatt, Danny Fox, Kyle Johnson and David Pesetsky for several discussions on topics related to this and for helping me work through the examples necessary for what happens to be extremely hard and fleeting judgements. I’m also grateful to Devon Denny, Adèle Mortier, Christopher Romero, Rachel Stacey, Anastasia Tsilia for the many judgements they provided and also to the GLOW in Asia XIII audience. This work is currently at its most initial stage and all errors are mine.

¹ All throughout this talk, I will only concern myself with restrictive RCs. So, unless otherwise mentioned, “RCs” is to be taken to refer to restrictive RCs.

2. Raising v. Matching

It's by now widely accepted in the literature that Raising accounts for reconstruction effects. *E.g.*, in (2a), *headway* needs to reconstruct into the object position of *made* to be interpreted idiomatically inside the idiom chunk *make headway*. In (2b), *aspect of herself* needs to reconstruct for *herself* to be able to be bound by *Alma* and satisfy Condition A. But, in (3), if Raising applies, then we should predict a Condition C violation, which we don't, that is, Matching applies here. This is the basic logic of the argument and I would refer the reader to the larger literature on this for more details (Bhatt 2002, Sauerland 1998, 2000, 2003, Hulsev and Sauerland 2006, henceforth "H&S").

(2) **Raising** → **reconstruction**

- a. the headway that John made
 b. the aspect of herself₁ that Alma₁ despises

(3) **Matching** → **antireconstruction**

the aspect of Alma₁ that she₁ despises

3. The Inadequacy of the Distinction

3.1. Hulsev and Sauerland (2006): Argument in Favor of the Distinction

According to Fox and Nissenbaum (1999) (henceforth F&N), we have the derivation in (4b) for an example like (4a): the DP is QRed, the higher copy is deleted because the movement is covert, and then the modifier *by John* is late merged to the restrictor of the higher copy. See F&N for extensive evidence in favor of such an analysis.

(4) a. We saw a painting yesterday by John.

b.

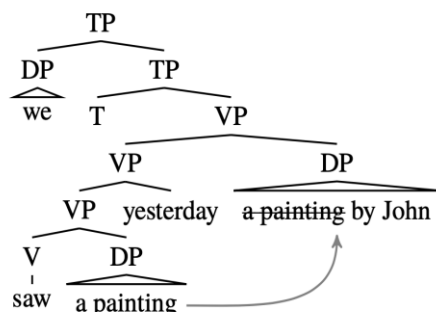

(Fox and Nissenbaum 1999, 3: 3)

Given this analysis, we make a prediction: if, instead of *by John*, we have a modifier which cannot be late merged, for some reason or another, that is, if it must be present in the structure throughout the time the modified DP is also in the structure, then that modifier shouldn't be able to be extraposed because extraposition of adjuncts, within this framework, must arise through Late Merge. Incidentally, Raising RCs happen to be exactly that sort of modifiers because, as we saw in (2a), the interpretation of the heads of Raising RCs is entirely dependent on its possibility of reconstruction into its internal structure, which is impossible if that internal structure is not present. That is, we predict that Late Merge/extraposition are incompatible with Raising RCs.

This prediction is borne out by examples given in H&S. Witness (5-6). (“#_{IC}” stands for “infelicitous with idiomatic interpretation”.) All of these examples involve Raising RCs

(idioms chunks in 5: *make headway* and *take advantage*; reflexives in the RC heads in 6: *himself* and *herself*) because, in order to ensure good semantics, the heads of these RCs must be able to reconstruct, which requires Raising. And whenever we force extraposition with the adverbs shown within parentheses, ungrammaticality is incurred.

- (5) a. Mary praised the headway (#_{IC} last year) that John made.
 b. I was shocked by the advantage (#_{IC} yesterday) that she took of her mother.

(H&S, 9; Sportiche 2017, 32-33)

- (6) a. I saw the picture of himself₁ (*yesterday) that John₁ liked.
 b. Mary discovered the book about himself₁ (*yesterday) that Bob₁ wrote.

(H&S, 13; Sportiche 2017, 29-30)

3.2. Henderson (2007): Argument against the Distinction

However, Henderson (2007) shows that what actually makes these examples ungrammatical is whether a good interpretation is possible in both the higher matrix clause (henceforth, “MC”, i.e., everything but the RC in the sentence/the part of the sentence from its left edge to the right edge of the crucial adverb signaling extraposition) and the RC. See the following examples that point precisely to this effect (8). *Heed*, *advantage*, and *headway* can be interpreted as part of the idiom chunks *pay heed*, *take advantage*, and *make headway* in the MC in (8a-c), respectively.

- (8) a. John paid the same heed last year that Mary paid.
 b. John took the same advantage last week that Mary took.
 c. John made the same headway last year that Mary made.

(9a from Henderson 2007, 28: 215; the rest mine)

This shows that the Raising v. Matching distinction doesn’t serve us explanatorily because, otherwise, all the examples in (8) would be bad because the Raising RC must be late merged in these extraposition examples. Henderson’s account for this has two parts. I will first present evidence against and reject the one in which he applies Vehicle Change and then preserve the other one.

4. Henderson (2007): A Quick Overview

Henderson’s (2007) idea was to posit Raising for all RCs, eliminate Matching, and, in A’-Movement, to have the option to apply Vehicle Change to every copy but the highest one. This enables a derivation like (9b) for (9a), which obviates the Condition C effect that would have raised without Vehicle Change. However, this doesn’t help with (10a), because the interpretation in which the universal quantifier outscopes the existential one, the disjoint reference effect persists, which means that the derivation in (10d) isn’t allowed; only the one in (10c) is. And that means that Henderson’s account doesn’t generalize to all A’-Movements.

- (9) a. the aspect of Alma₁ that she₁ despises
 b. [DP the [[NP aspect of Alma₁] [CP [NP aspect of her₁] that [TP she₁ [VP likes [NP aspect of her₁]]]]]]
- (10) a. *Someone talked to him₁ about every relative of John₁.
 b. *Only interpretation considered* → ∀ > ∃
 c. *Derivation without VEHICLE CHANGE*
 *⟨Every relative of John₁⟩ someone talked to him₁ about every relative of John₁?
 d. *Derivation with VEHICLE CHANGE*
 ✓⟨Every relative of John₁⟩ someone talked to him₁ about every relative of him₁?

So, I will now show how WLM can be used to substitute this Vehicle Change idea.

5. Wholesale Late Merge

Given the problematic aspect of Henderson's Vehicle Change idea, my alternative to Matching is WLM. (11) is T&H's concept of WLM in my words.

- (11) **WHOLESALE LATE MERGE (WLM)** *(first attempt)*
 The merging of the NP restrictor of a DP *can* be delayed until it reaches its final Case position, that is, the Case position in a derivation after which it's never merged into a Case position again.

This insight was an extension of the idea of late merging adjuncts, explored in Lebeaux (1988 *et sequentia*), F&N and Fox (2002). Instead of adjuncts, T&H late merges the NP restrictor of a DP. T&H exploits WLM to delay the merging of the NP restrictor in the A-Moving DPs in (12) to account for the fact that Condition C effects are unattested here, which would have been attested if the NP could be merged in embedded SpecTP because the c-commanding and coreferent pronouns in the *to*-phrases. But by the time the derivation gets to the matrix SpecTP, which is the final Case position, the NP must be merged, which is why we get the Condition C effect in (10a), where, in order to obviate the Condition C effect, we must be able to delay the merging of the NP until SpecCP, which c-commands the final Case position, *i.e.*, the object position of *bring*.

- (12) a. [The claim that John₁ was asleep] seems to him₁ to be correct.
(Chomsky 1993: 37; T&H, 8a)
 b. [Every argument that John₁ is a genius] seems to him₁ to be flawless.
(Fox 1999: 192; T&H, 8b)
 c. [This aspect of Sue₁] seemed to her₁ [___ to be beyond reproach].
(Pesetsky 2022, 15b)

However, this same anti-reconstruction effect is observable in A-Scrambling, where movement happens not *to* Case positions, but *from* them. It's widely known, from the Scrambling literature, that clause-internal movement and extraction from non-finite clauses are instances of A-Scrambling, while extraction from finite clauses are A'-Scrambling, and this split is consistent with the general profile of the A-v-A'-Movement distinction. (Hindi: Keine 2016, 2018a,b, Keine and Dash 2018, following Gambhir 1981, Déprez 1989, Mahajan 1990, 1994, Gurtu 1992, Dayal 1994, Kidwai 2000, *inter alia*, Japanese: Saito 1985, 1989, 1992, 2003, 2004, Saito and Hoji 1983, *inter alia*, Korean: Tossups 1999, 2003, 2007, *inter alia*). For

instance, in the Hindi examples below, (13-14) constitute A-Movement, creating a new antecedent (*raam aur prataap* “Ram and Pratap”) for binding the reciprocal (*ek-duusre-kii* “each other’s”), while (15) constitutes A’-Movement and doesn’t create new antecedent for binding.

(13) *HINDI*

Scrambling inside a clause

- a. *[**ek-duusre-kii**₁ bahinō-ne] [**raam aur prataap**] -ko₁ maaraa.
 each other’s sisters-ERG Ram and Pratap -ACC hit
 “*Each other’s₁ sisters hit [Ram and Pratap]₁.”
- b. [**raam aur prataap**] -ko₁ [**ek-duusre-kii**₁ bahinō-ne] t₁ maaraa
 Ram and Pratap -ACC each other’s sisters-ERG hit
 “[Ram and Pratap]₁, each other’s₁ sisters hit t₁.”

(Keine 2018a, 11: 6)

(14) *HINDI*

Scrambling out of a non-finite clause

- a. *[**ek-duusre-kii**₁ bahinō-ne] [TP [**raam aur prataap**] -ko₁ maanaa] caahaa.
 each other’s sisters-ERG Ram and Pratap -ACC hit.INF wanted
 “*Each other’s₁ sisters wanted to hit [Ram and Pratap]₁.”
- b. [**raam aur prataap**] -ko₁ [**ek-duusre-kii**₁ bahinō-ne] [TP t₁ maanaa] caahaa.
 Ram and Pratap -ACC each other’s sisters-ERG hit.INF wanted
 “[Ram and Pratap]₁, each other’s₁ sisters wanted to hit t₁.”

(Keine 2018a, 14: 7)

(15) *HINDI*

Scrambling out of a finite clause

- *[**raam aur prataap**] -ko₁ [**ek-duusre-kii**₁ bahinō-ne] socaa [CP ki sangiitaa-ne t₁
 Ram and Pratap -ACC each other’s sisters-ERG thought that Sangita-ERG
 maaraa].
 hit
- Intended* → “[Ram and Pratap]₁, each other’s₁ sisters thought that Sangita had hit t₁.”

(Keine 2018a, 16: 8)

This means that WLM should be generalized to movement to A-positions, and not just to Case positions and then we will be able to delay the merging of the crucial NP long enough for it to escape the c-command domain of the reciprocal. Here’s an attempt to capture that (16).

(16) **WHOLESALE LATE MERGE (WLM)**

(second attempt)

The merging of the NP restrictor of a DP *can* be delayed until it reaches the final A-position, that is, the A-position in a derivation after which it’s never merged into another A-position again.

This can be exploited in RCs because the RC-internal head resides in an A-position inside the RC and then, after its movement, the whole relativized DP with the moved NP head is in an A-position in the sentence that this relativized nominal is part of. That is, this is precisely the kind

of situation where WLM is licensed. The specifics of that will depend on the properties of Johnson’s (2018) multidominant model of DP movement that I will now introduce.²

6. Multidominance and RCs

I will now present the parallelism between the traditional Copy Theory of DP movement and its multidominant variant. (17) is how movement is envisioned within Copy Theory, where the lower copy is interpreted via Trace Conversion, as given in (18).

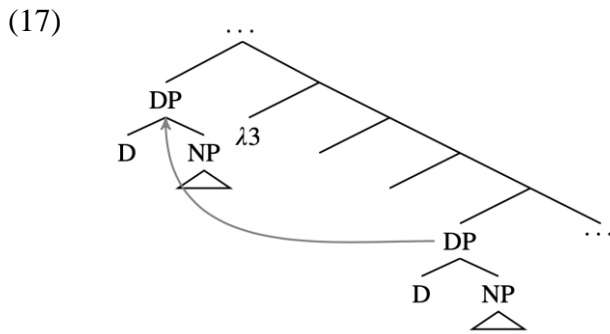

TRACE CONVERSION

- (18)
- a. *Variable Insertion:*
(Det) Pred → (Det) [Pred λy . y = x]
 - b. *Determiner Replacement:*
(Det) [Pred λy . y = x] → the [Pred λy . y = x]

(Fox 2002, 10: 67)

Johnson’s (2018) idea — also developed and used in Johnson (2009, 2012), Fox and Johnson (2016), O’Brien (2017) and Poole (2017) — was to do away with this separate notion of Trace Conversion and build the *result* of it into the structure itself. For instance, (19) would be the multidominant equivalent of (17). DP[‡], here, should be treated as the converted trace, “D” as the replacing predicate — with a null phonology and the same semantics as English *the* — and “3”, as having the semantics, “λy_e . y = x₃”. Then, the NP undergoes Parallel Merge with D[‡], the determiner that gets spoken, which can be any quantificational determiner like *every*, *few*, *no*, *etc.*, and DP[‡] is then merged into the position where the DP is actually pronounced.³

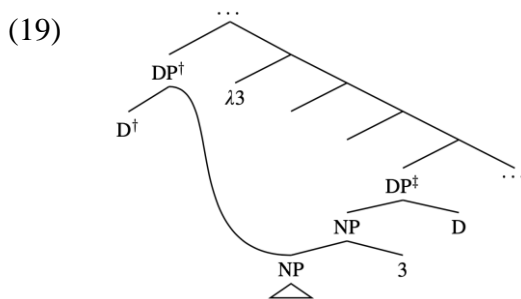

² I will hint at the necessity for multidominance as I conclude the paper. In short, a multidominant framework allows us to state generalizations invoking whether nodes are completely or incompletely dominated (in the sense of O’Brien 2017) by other nodes.

³ The notion of Parallel Merge was developed in Barbara Citko’s work in a different context (Citko 2005 *et sequentia*). But it’s quite useful in Johnson’s implementation too.

Thus, it should be evident why (17) and (19) are semantically completely equivalent, except that Trace Conversion is yet to apply to (17).

Given this conception of DP movement, where the DP itself never moves — but its NP restrictor is remerged — (20) is how WLM must be envisioned within this multidominant system to create the effect of the restrictor being absent in the “lower copy”. ($\llbracket T \rrbracket$ has the semantics “ $\lambda x_e . x = x$ ”. The need for this tautological predicate becomes apparent later, in (24a). In its absence, the only other node that could act as the hinge of multidominance would be “3”. But then, “ $\lambda x_e . x = g(3)$ ” would be part of the meaning of the RC head. That means that the restrictive meaning of the RC is lost because the head is already specified as the distinct entity that g maps 3 to. That is, we end up predicting that restrictive RCs don’t exist and that these RCs can only have appositive readings, which is clearly not the case. To prevent this, I use this tautological predicate.) Moreover, since no DP moves here, the WLM in (16) doesn’t work. (21) is the final, revised version. (Thanks to Danny Fox for suggesting this wording.)

(20)

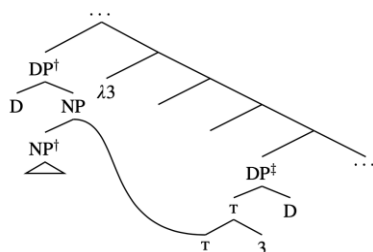

(21) **WHOLESALE LATE MERGE (WLM)** *(final version)*
 An NP must have at least one path extending from it to the root such that the first DP in this path, counting from the NP, is in an A-position.

If DP^\dagger is in an A-position, then (21) is satisfied, which accounts of the antireconstruction data in A-Movement (12-15), while if it’s in an A’-position, then (21) isn’t satisfied and such an instance of WLM is banned, which accounts for the reconstruction effect in A’-Movement (10a).

In RCs, the RC-internal head NP is shared as in Johnson’s work and adjoins to the CP to create the larger modified NP (22). There are two paths extending from the multidominated NP: one contains just DP^\dagger and another, DP^\dagger and DP^\ddagger . Both of these DPs are in A-positions. So, if we apply WLM during the remerging of the NP, then we’ll be able to create a structure similar to (21) and, because of the two positions being A-positions, the WLM condition will be satisfied (22).

- (22) The book that Alma despises is on the table.
 Structure for the relativized DP

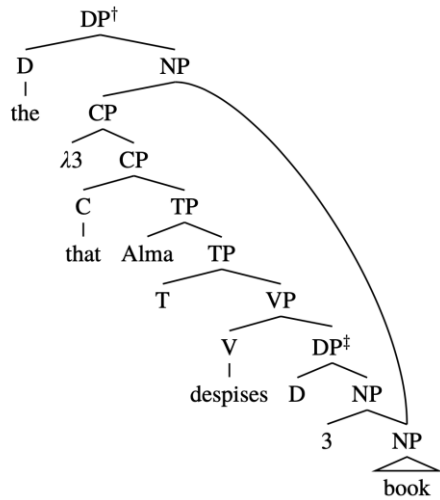

Therefore, for (23), both (24a) (with WLM) and (24b) (without WLM) will be available in principle. However, in (24b), Condition C is violated because of *Alma* being c-commanded by a coreferent *she*, so this structure will crash. For (25), (26a) will crash because *herself* isn't bound in it and Condition A is thus violated, while (26b) will survive because there is no such violation of Condition A. (27) works the same way (25) does: since “reconstruction” of *headway* is needed, the WLM derivation in (28a) crashes, the one without it in (28b) doesn't.

- (23) the aspect of Alma₁ that she₁ despises

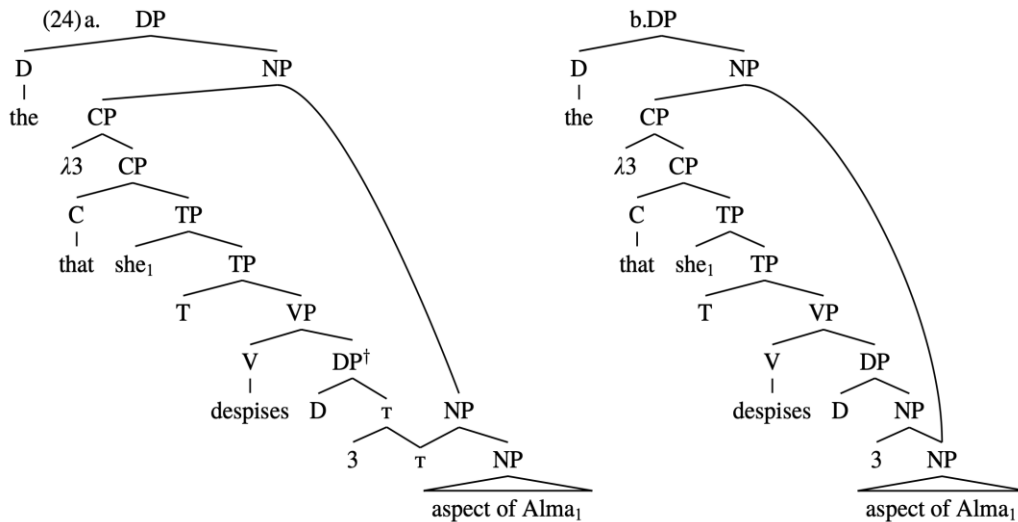

(25) the aspect of herself₁ that Alma₁ despises

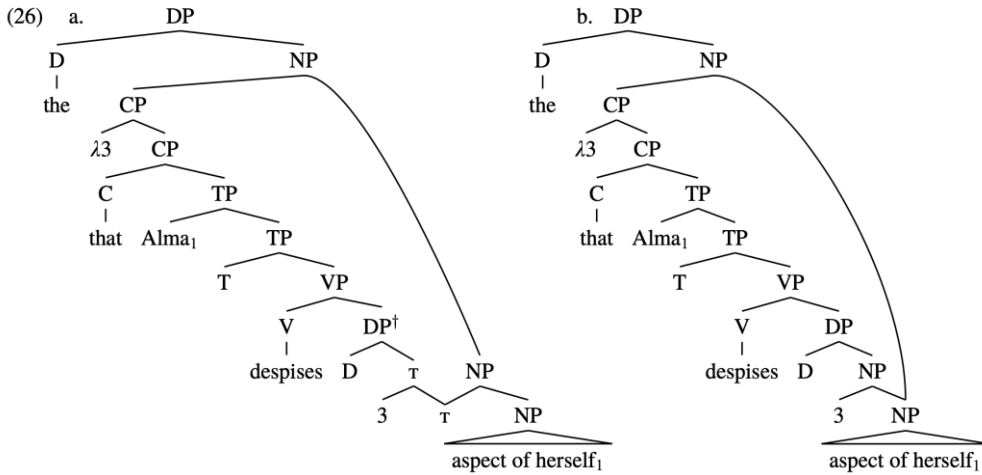

(27) the headway that Alma made

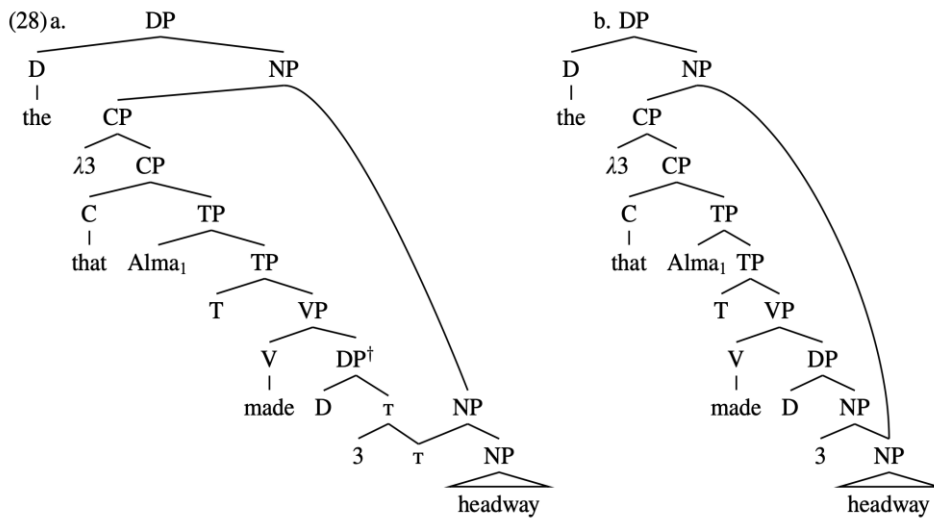

7. Extraposition

Recall the H&S examples repeated here in (29-30), which initially showed the incompatibility between Late Merge and Raising, which were then refuted by Henderson's examples in (8) above. We're now in position to understand this phenomenon.

- (29) a. Mary praised the headway (#_{IC} last year) that John made.
 b. I was shocked by the advantage (#_{IC} yesterday) that she took of her mother.

(H&S, 9)

- (30) a. I saw the picture of himself₁ (*yesterday) that John₁ liked.
 b. Mary discovered the book about himself₁ (*yesterday) that Bob₁ wrote.

(H&S, 13)

The structures of the non-extrapolation versions of (29a) and (30a) are given below for convenience.

(31) Mary praised the headway that John made.

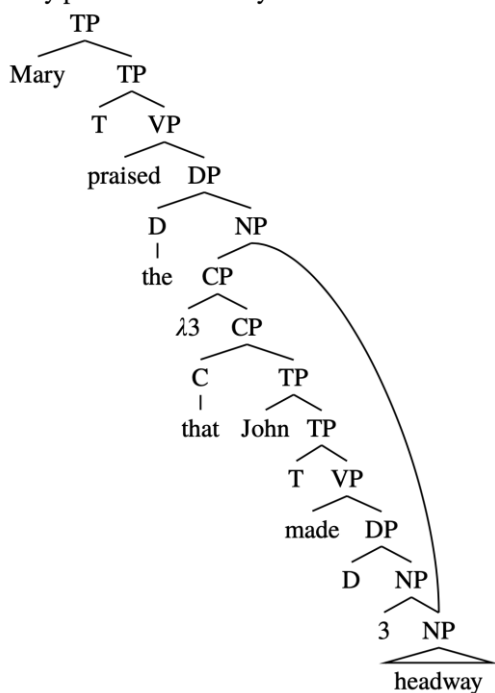

(32) I saw the picture of himself that John liked.

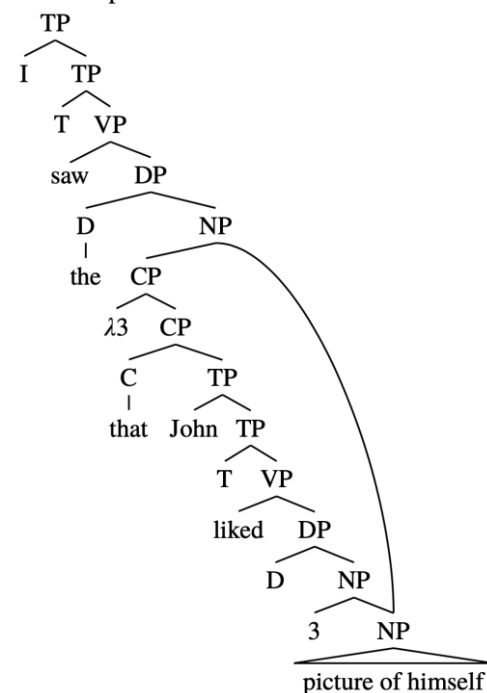

Given the dissolution of the distinction between Raising v. Matching in my account of RCs, we would now want to understand what makes (29-30) bad, which we can, by trying to deriving them. Recall that we're assuming Johnson's rendition of F&N's account for extraposition. Given that, for (29a), for instance, the VP in (33) is first going to have to be built — to the edge of which a larger DP will merge, just as in (4b).

(33)

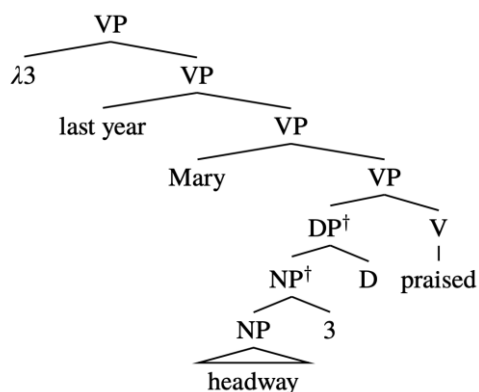

It's crucial to understand the following at this point of the derivation: the NP restrictor *headway* must be present, as in, merged into, the MC, by which I mean the object position of *praised* in the clause *Mary praised the headway*. That is because otherwise it will have no way to be pronounced there. In other words, we cannot have a derivational route in which, as in an instance of WLM, the merging of the NP restrictor *headway* is delayed because, in a later step

of the derivation, we'll have an A-position where this NP can still be merged and satisfy the WLM condition, because of its consequences for linearization, regardless of what linearization algorithm we espouse.

After (33), the derivational step I propose is also one advocated for by Henderson: Sideward Movement (Nunes 2001 *inter alia*) — in order to bring what is supposed to become the head of the RC, *headway*, into the RC itself. That means, within our multidominant system, treating DP^\dagger as the converted trace of the movement and share its NP restrictor *headway* accordingly, just as in (19). When that and the following steps of Merge to build the whole RC and the relativized DP are completed and then this relativized DP is merged to the edge of the VP in (33), as in the case of extraposition in (4b), we obtain (34) for (29a). An identical derivation with different lexical items yields (35) for (30a).

(34) Mary praised the headway ($\#_{IC}$ last year) that John made.

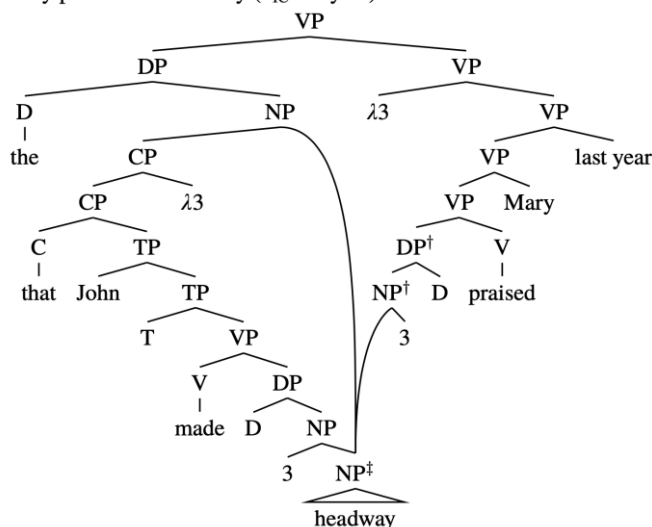

(35) I saw the picture of himself₁ (*yesterday) that John₁ liked.

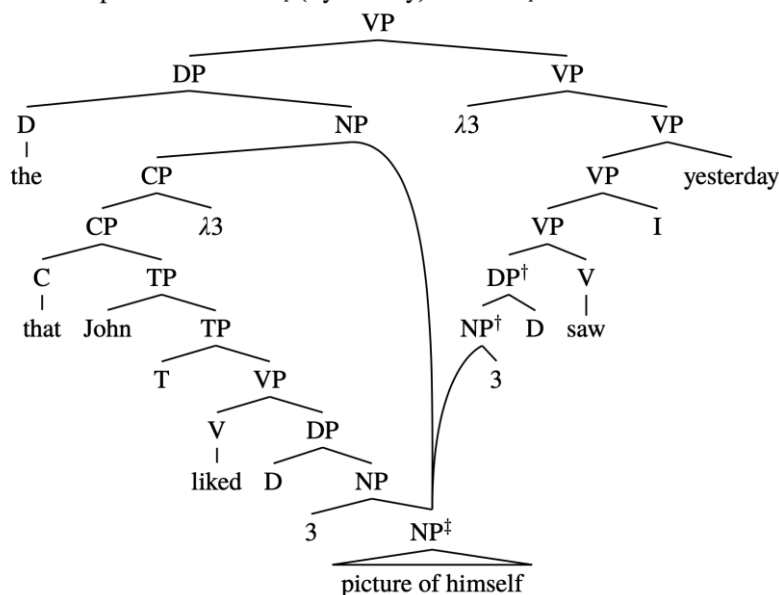

This means that we have a way to derive the sentences in (29-30). Then the question is: what makes them bad? I argue, again concurring with Henderson in this respect, that what makes

these sentences bad is not the syntax but the semantics: *headway*, in (34), can't be interpreted as the object of *praise* in the MC idiomatically, which prevents the idiomatic interpretation, while *himself*, in (35), is free in the MC, because *I* can't bind it there, violating Condition A. These interpretive conflicts between the RC and the MC are what makes these sentences anomalous.

As a result of that, once the MC is enabled to provide an appropriate semantics unlike in (29-30), we obtain grammaticality, which was shown in Henderson's own examples in (8). This way of understanding RCs and extraposition thus allows us to explain the discrepancy between the examples in (29-39) and (8).

8. Concluding Remarks

The purpose of this paper was to provide an account of the antireconstruction effect in RC heads that would eliminate the additional operation of Matching so far accepted in the literature and explain certain somewhat ignored extraposition data. It does so by proposing WLM to derive RCs across the board, thus eliminating Matching and then applying this to Henderson's (2007) approach to extraposition. This entire account is couched within a multidominant framework for DP movement developed by Johnson (2018) *inter alia*.

One thing that's often a cause for alarm when it comes to multidominant structures like the ones I have above is linearization. I have some thoughts on how to proceed on that front: Johnson (2012) develops a linearization algorithm to tackle multidominant structures of extraposition, which can be exploited to linearize these structures. Johnson didn't have Raising, *i.e.*, WLM and Sideward Movement the way I have shown, but his fundamental concepts will be useful. However, I cannot fully implement and elaborate on here for reasons of space. I will leave that for future research.

There's one rather significant issue I must address in conclusion, concerning the interpretation of NPs. Observe in (34-35) that what we must say in order to ensure that these structures yield anomalous semantics is in effect that an NP must be interpreted in every single position where it sits in a structure. Otherwise, we could count only the position of the shared NPs inside the RCs for the interpretation and the critical position in the MC where these NPs cannot receive a proper interpretation could be disregarded, as just another position it occupied during the derivation — which, as it turns out, is what we ought to do in the derivations of the *Wh*-Questions given below, where we must disregard the higher position in order to account for the reconstruction effect helping the idiomatic interpretation (36) and the satisfaction of Condition A (37). So, the question we're now faced with is: why is it that we must entertain both positions occupied by the NP in (34-35) for the purposes of interpretation, but can't, in (36-37)?

(36) What headway has Alma made?

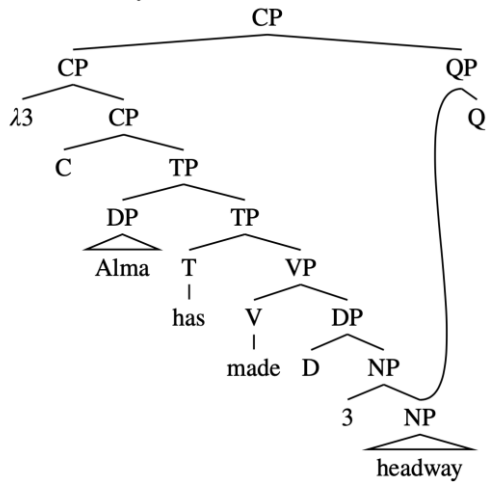

(37) Which aspect of herself₁ does Alma₁ despise?

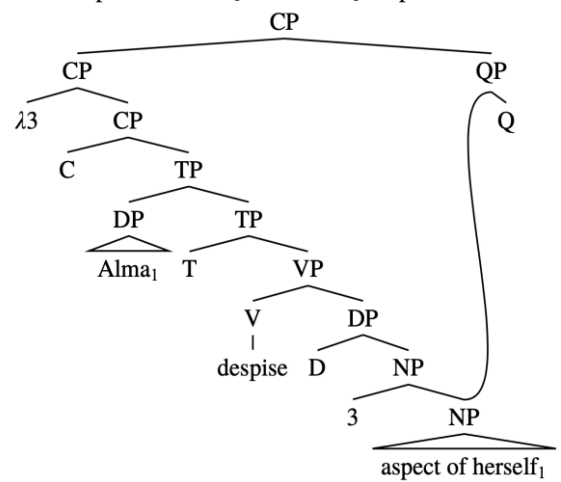

This is probably the most interesting question this paper makes us contemplate and following this cue will lead us to understand intriguing patterns in the interpretation of DPs and their NP restrictors. I have begun to develop a preliminary sketch of an answer to this question, which involves adjusting structures like (36-37) somewhat and understanding Condition A — and conditions on the interpretation of DPs in general — in terms of complete v. incomplete dominance, to which I've alluded in footnote 3 above. I will leave that to be developed in future research and conclude this paper here.

References

- Bhatt, Rajesh. 2002. The raising analysis of relative clauses: evidence from adjectival modification. *Natural Language Semantics* 10:43–90.
- Chomsky, Noam. 1993. A minimalist program for linguistic theory. In *The view from Building 20*, ed. Ken Hale and Jay Keyser, 1–52. Cambridge, Massachusetts: MIT Press.
- Citko, Barbara. 2005. On the nature of merge: External merge, internal merge, and parallel merge. *Linguistic Inquiry* 36:475–496.
- Déprez, Vivian. 1989. On the typology of syntactic positions and the nature of chains. Doctoral Dissertation, MIT, Cambridge, Massachusetts.
- Fox, Danny. 1999. Reconstruction, binding theory, and the interpretation of chains. *Linguistic Inquiry* 30:157–196.
- Fox, Danny. 2002. Antecedent-contained deletion and the copy theory of movement. *Linguistic Inquiry* 33:63–96.
- Fox, Danny, and Kyle Johnson. 2016. QR is restrictor sharing. In *Proceedings of the 33rd West Coast Conference on Formal Linguistics*, ed. Kyeong-min Kim, Pocholo Umbal, Trevor Block, Chan Queenie, Tanie Cheng, Finney Kelli, Mara Katz, Sophie Nickel-Thompson, and Shorten Lisa, 1–16.
- Fox, Danny, and Jon Nissenbaum. 1999. Extraposition and scope: a case for overt QR. In *Proceedings of the West Coast Conference on Formal Linguistics 18*, ed. Sonya Bird, Andrew Carnie, Jason D. Haugen, and Peter Norquest, 132–144. Somerville, Massachusetts: Cascadilla Press.
- Gambhir, Vijay. 1981. Syntactic restrictions and discourse functions of word order in Standard Hindi. Doctoral Dissertation, University of Pennsylvania, Philadelphia, Pennsylvania.
- Gurtu, Madhu. 1992. *Anaphoric relations in Hindi and English*. New Delhi: Munshiram Manoharlal.
- Henderson, Brent Mykel. 2007. Matching and raising unified. *Lingua* 117.1:202–220.
- Hulsey, Sarah, and Uli Sauerland. 2006. Sorting out relative clauses. *Natural Language Semantics* 14:111–137.
- Johnson, Kyle. 2009. Why movement? Unpublished manuscript, University of Massachusetts at Amherst.
- Johnson, Kyle. 2012. Toward deriving differences in how Wh movement and QR are pronounced. *Lingua* 122:529–553.
- Johnson, Kyle. 2018. Movement as Multidominance. Lecture notes from a course taught at the University of Crete, Rethymnon.
- Keine, Stefan. 2016. Probes and their horizons. Doctoral Dissertation, University of Massachusetts at Amherst.
- Keine, Stefan. 2018a. Case vs. positions in the locality of A-movement. *Glossa* 3.1:1–34.
- Keine, Stefan. 2018b. Selective opacity. *Linguistic Inquiry* 50.1:13–61.
- Keine, Stefan, and Bhamati Dash. 2018. The ups and downs of agreement. Ms. Los Angeles, CA: University of Southern California.
- Kidwai, Ayesha. 2000. *XP-adjunction in universal grammar: scrambling and binding in Hindi-Urdu*. Oxford: Oxford University Press.
- Lebeaux, David. 1988. Language acquisition and the form of the grammar. Doctoral Dissertation, University of Massachusetts, Amherst.
- Mahajan, Anoop K. 1990. The A/A-bar distinction and movement theory. Doctoral Dissertation, Massachusetts Institute of Technology.

- Mahajan, Anoop K. 1994. Towards a unified theory of scrambling. In *Studies on scrambling: Movement and nonmovement approaches to free word-order phenomena*, ed. Norbert Corver and Henk van Riemsdijk, 301–330. Berlin: de Gruyter.
- Moulton, Keir. 2009. Natural selection and the syntax of clausal complementation. Doctoral Dissertation, University of Massachusetts at Amherst.
- Nunes, Jairo. 2001. Sideward movement. *Linguistic Inquiry* 32:303–344.
- Pesetsky, David. 2022. Spring 2022 lecture notes.
- Poole, Ethan. 2017. Movement and the semantic type of traces. Doctoral Dissertation, University of Massachusetts at Amherst.
- Saito, Mamoru. 1985. Some asymmetries in Japanese and their theoretical implications. Doctoral Dissertation, Massachusetts Institute of Technology.
- Saito, Mamoru. 1989. Scrambling as semantically vacuous A'-movement. In *Alternative conceptions of phrase structure*, ed. Mark R. Baltin and Anthony S. Kroch, 182–200. Chicago: University of Chicago.
- Saito, Mamoru. 1992. Long distance scrambling in Japanese. *Journal of East Asian Linguistics* 1:69–118.
- Saito, Mamoru. 2003. A derivational approach to the interpretation of scrambling chains. *Lingua* 113:481–518.
- Saito, Mamoru. 2004. Japanese scrambling in a comparative perspective. In *Peripheries: Syntactic edges and their effects*, ed. David Adger, Cécile de Cat, and George Tsoulas, 143–163. Dordrecht, The Netherlands: Kluwer Academic Publishers.
- Saito, Mamoru, and Hajime Hoji. 1983. Weak crossover and move α in Japanese. *Natural Language and Linguistic Theory* 1:245–259.
- Sauerland, Uli. 1998. The meaning of chains. Doctoral Dissertation, Massachusetts Institute of Technology.
- Sauerland, Uli. 2000. Two structures for English restrictive relative clauses. In *Proceedings of the Nanzan GLOW*, 351–366.
- Sauerland, Uli. 2003. Unpronounced heads in relative clauses. In *The interfaces: deriving and interpreting omitted structures*, ed. Kerstin Schwabe and Susanne Winkler, 205–226. John Benjamins Publishing Company.
- Sportiche, Dominique. 2006. Reconstruction, binding and scope. In *The Blackwell companion to syntax*, ed. Martin Everaert and Henk van Riemsdijk, volume IV, 35–93. Oxford: Blackwell.
- Sportiche, Dominique. 2017. Relative clauses: promotion only, in steps. Unpublished manuscript, UCLA.
- Takahashi, Shoichi, and Sarah Hulsey. 2009. Wholesale late merger: Beyond the A/A' distinction. *Linguistic Inquiry* 40:387–426.
- Tsoulas, George. 1999. On long-distance scrambling in Korean. In *Harvard studies in Korean linguistics*, 217–302. Hanshin Publishers.
- Tsoulas, George. 2003. Base generation of Korean long distance scrambling: A re-examination of the arguments and their consequences. Manuscript, University of York.
- Tsoulas, George. 2007. Long distance scrambling and anaphora. In *Selected papers on Theoretical and Applied Linguistics*, ed. Eleni Agathopoulou, Maria Dimitrakopoulou, and Despina Papadopoulou, volume 17, 220–232. Aristotle University of Thessaloniki.

Accessibility on Reconstruction: Japanese Head-External Relative Clauses by Form Copy*

Norimasa Hayashi

Nanzan University

1. Introduction

This study discusses Japanese head-external relative clauses (RCs) in terms of Chomsky's (2021) Form Copy. (1) shows an example of Japanese RCs:

- (1) [Taro-ga ~~zibun-no~~ ~~hahaoya~~ atta] **zibun-no hahaoya**
 T.-NOM self-GEN mother met self-GEN mother
 'himself's mother that Taro met'

As the bold-faced head of the RC contains an anaphor, the head must reconstruct into the base position in the RC. The central issue of this paper is long-distance RCs like (2):

- (2) Taro-ga [Hanako-ga ~~zibun-no~~ ~~hahaoya~~ atta-to] **zibun-no hahaoya**
 T.-NOM H.-NOM self-GEN mother met-C believing self-GEN mother
 'himself's/*herself's mother that Taro believes Hanako met'

Although the base position of the head must be in the embedded clause, it cannot reconstruct into its base position; the anaphor can be coreferential with the higher subject *Taro*, but not with the lower subject *Hanako*. This behavior is strange if the head moves to the spell-out position through the spec of the embedded CP.

- (3) [DP [RC ...Taro...[CP \overline{DP} [C' ...Hanako... \overline{DP} ...]]] DP

Japanese RCs show the same behavior with the weak crossover (WCO) effect.

- (4) a. ?[~~futatu-no~~ ~~daikigyoo~~ [soko-no kogaisya]-o tyoosasita] **futatu-no**
 two.CLF-GEN big.enterprise that.place-GEN subsidiary-ACC investigation.did two.CLF-GEN
daikigyoo
 big.enterprise
 'the two big enterprises that investigated its subsidiaries' (Miyamoto 2017: 618)
- b. *[[soko-no kogaisya]-ga ~~futatu-no~~ ~~daikigyoo~~ tyoosasita] **futatu-no**
 that.place-GEN subsidiary-NOM two.CLF-GEN big.enterprise investigation.did two.CLF-GEN
daikigyoo
 big.enterprise
 'its subsidiaries that investigated the two big enterprises' (Miyamoto 2017: 618)

As the head is base-generated in the object position in (3b), the movement from there crosses

* I appreciate the audiences of GLOW in Asia XIII. This work was supported by JSPS KAKENHI Grant Number JP21K19987 and Nanzan University Pache Research Subsidy I-A-2 for the academic year 2022.

the coreferent subject, yielding the WCO effect. However, the WCO effect is not operative in long-distance RCs.

- (5) a. [keisatu-ga [~~futatu-no~~—~~daikigyoo~~ [soko-no kogaisya]-o
 police-NOM two.CLF-GEN big.enterprise that.place-GEN subsidiary-ACC
 tyoosasita]-to sinziteiru] **futatu-no daikigyoo**
 investigation.did-C believing two.CLF-GEN big.enterprise
 ‘the two big enterprises that the police believes investigated its subsidiaries’
 (Miyamoto 2017: 619)
- b. [keisatu-ga [[soko-no kogaisya]-ga ~~futatu-no~~—~~daikigyoo~~
 police-NOM that.place-GEN subsidiary-NOM two.CLF-GEN big.enterprise
 tyoosasita]-to sinziteiru] **futatu-no daikigyoo**
 investigation.did-C believing two.CLF-GEN big.enterprise
 ‘the two big enterprises that the police believes its subsidiaries investigated’
 (Miyamoto 2017: 619)

(5a, b) are well-formed regardless of the base positions of the head. It means that as in (2), the heads do not reconstruct into their base positions, evading the WCO effect. The generalization is as follows: reconstruction effects (anaphor licensing, the WCO effect) are observed in short RCs, whereas the head can only reconstruct into the highest clause in long-distance RCs. This property, the highest clause sensitivity (Kizu 2005), is not observed in English RCs.

(6) **The picture of himself** that John thinks ~~the picture of himself~~ Bill likes ~~the picture of himself~~ best.

In (6), either the matrix or embedded subject can be the antecedent of the anaphor in the head. It is assumed that the head moves from the base position in English RCs, which explains the reconstruction effect (Kayne 1994); the anaphor can be licensed anywhere through the derivation. Based on this perspective, Japanese RCs pose a puzzle. If Japanese RCs are derived by movement like English, they are expected to demonstrate the full reconstruction into the base position as in English RCs. The different behavior of Japanese RCs from English ones suggests that Japanese RCs are not derived by movement. In fact, a genuine movement construction in Japanese, the long-distance scrambling, behaves like English RCs.

- (7) Zibun-no hahaoya-no kanbyoo-o Taro-wa [~~zibun-no hahaoya-no~~—~~kanbyoo-o~~ [Hanako-ga
 self-GEN mother-GEN nursing-ACC T.-TOP self-GEN mother-GEN nursing-ACC H.-NOM
~~zibun-no hahaoya-no~~—~~kanbyoo-o~~ suru-to]] omotteiru.
 self-GEN mother-GEN nursing-ACC do-C thinking
 ‘Taro thinks that Hanako nurses self’s mother.’

The embedded object moves from the base-generated position to the sentence-initial position via the spec of the embedded CP, and the antecedent of the anaphor can be either the matrix or the embedded subject, demonstrating the reconstruction effect. The observation leads us to suggest that Japanese long-distance RCs involve derivation other than movement. Previous analyses follow this assumption. Ishii (1991), Kizu (2005), and Miyamoto (2017), among others, assume that short RCs are derived by movement, but long-distance RCs involve *pro*. I demonstrate the derivation of RCs with the null operator, following their derivations.

- (8) a. short RC: [[RC Op [... \emptyset ...]] DP]
 b. long-distance RC: [[[RC Op [CP ... \emptyset ...[C' ...*pro*...]]...] DP]

In short RCs in (8a), the null operator moves in the RC and connects the RC and the base-generated head outside the RC. In contrast, *pro* is located in the theta-position in the long-distance RC (8b), and a null operator, base-generated in the spec of CP, moves in the highest clause. This analysis can explain why long-distance RCs do not indicate reconstruction effects, but three problems arise concerning the derivation. First, it cannot explain why long-distance RCs cannot be derived by movement. It is just a stipulation to assume that short RCs are derived by movement and long-distance RCs are derived by *pro*. Second, additional assumptions seem necessary for reconstruction data. They assume that the null operator moves in Japanese RCs. Hence, the null operator must yield reconstruction effects, but the assumption does not coincide with the original motivation for the raising analysis (Schachter 1973, Vergnaud 1974, and Kayne 1994, among others). Head raising is required because the null operator is insufficient for the reconstruction effect. Finally, questions remain on the movement of the null operator, especially in (8b). Why is the null operator base-generated in the spec of CP, and what does the null operator do? Intuitively, the movement of the null operator mediates the relation between *pro* and the head outside the RC, but the exact mechanism is unclear. I will propose a simpler derivation for RCs below. However, before that, the following section summarizes Chomsky's (2021) Form Copy, on which my proposal is based.

2. Form Copy

When two identical objects appear in the structure, the system must determine whether the relation is a copy or a repetition. In Chomsky (2008: 145), they are distinguished by phase-level memory. If the two items are introduced separately from the lexicon, they are repetitions, and if the relation is formed by internal Merge (movement), they are copies. However, Chomsky (2021) suggests that the derivation has a strictly-Markovian property and abandons memory from syntax. If so, the derivational history does not help identify the relation. Chomsky instead assumes an operation Form Copy, which assigns the copy relation between two identical objects. Thus, internal Merge is no longer a prerequisite for the copy relation, and a copy relation can be assigned between the objects introduced by external Merge. Chomsky calls this relation an M-gap.

The two relations, copy by internal Merge and M-gap, conform to Duality of Semantics and Theta Theory. They are defined as follows:

- (9) Duality of Semantics (Chomsky 2021: 18)
 E[xternal]M[erge] is associated with θ -roles and I[nternal]M[erge] with discourse/information-related functions.
- (10) Θ -Theory (Chomsky 2021: 21)
 A θ -assigner assigns no more than a single θ -role to an S[yntactic]O[bject] and a θ -position cannot receive more than one θ -role.

Note that (10) does not preclude one syntactic object from receiving multiple theta-roles if different predicates assign each theta-role to the object. Let us consider the following raising and control constructions:

- (11) a. John seems to win.
 b. [John [seems John to win]]
- (12) a. John tried to win.
 b. [John [tried John to win]]

The two inscriptions of *John* in (11b) are copies by internal Merge because only one inscription is in a theta-position.¹ In contrast, each inscription in (12) receives the theta-role from *tried* and *win*. Hence, they must be introduced by external Merge independently according to (9), and the copy relation is an M-gap. In turn, (10) precludes the copy relation in the following example:

- (13) John likes John.

If the two inscriptions of *John* are copies, *like* assigns the two theta-roles to *John*, which violates (10). Therefore, they must be repetitions in this case.

Chomsky (2021) further argues that the interpretive systems can distinguish the two relations.

- (14) a. one interpreter each seems [to have been assigned ~~one interpreter each~~ to the diplomats]
 copy by internal Merge (cf. Chomsky 1981: 61)
- b. *one interpreter each [~~one interpreter each~~ tried [to be assigned ~~one interpreter each~~ to the diplomats]]
 copy by internal Merge M-gap (cf. Chomsky 1981: 61)

For distributive reading, *one interpreter each* must reconstruct into its base position in (14). Chomsky explains the contrast with the assumption that copies by internal Merge yield reconstruction effects, but M-gaps do not. Consequently, (14b) is ill-formed because *one interpreter each* cannot reconstruct into its base position because of the M-gap relation. Assuming two types of relations under the rubric of the copy relation, Chomsky deduces the traditional contrast between PRO and trace without assuming PRO. However, Japanese RCs are still problematic with this proposal. As the analysis only expects the relation with reconstruction and the one without reconstruction, it does not accommodate Japanese RCs, which demonstrate the relation with reconstruction up to the highest clause.

Slightly modifying Chomsky's assumption, I propose the following rule for reconstruction.

- (15) The interpretive systems can only trace the uniform operation.

Although it departs from Chomsky's bifurcation, (15) also explains the contrast in (14). In (14a), the relation is made by internal Merge. Reconstruction can occur as the relation is uniform. However, in (14b), two kinds of relations are involved; the lower relation is an M-gap, and the higher one is a copy by internal Merge. The interpretive system can trace the higher copy relation, but it cannot go further because the lower relation is not formed by internal Merge, failing to produce the distributive reading. Note that (15) allows reconstruction

¹ Chomsky seems to assume that *to* is a part of a verb. Hence, the lower inscriptions in (11) and (12) are located in the theta-positions (the spec of v^*P).

in the successive cyclic movement observed in an English RC (6). More than one copy relation is involved, but as long as all relations are made by uniform operation, internal Merge in (6), the interpretive systems allow reconstruction into the base position. In the following section, I deduce the highest sensitivity with (15).

3. Analysis

I summarize the assumptions as follows:

- (16) a. Japanese RCs involve M-gap relations.
 b. Form Copy applies at the phase level. (Chomsky 2021)
 c. At the completion of a phase, the lower phase becomes inaccessible.
 (Saito 2017, cf. Chomsky 2000)

Let us see Saito's (2017) assumption (16c) with the following English schemata:

- (17) a. [v^* [$\mu\phi$] [V, OBJ]]
 b. [v^* [V[$\mu\phi$], OBJ]]
 c. [v^* [V[$\mu\phi$], OBJ]]
 d. [C[$\mu\phi$] [SUBJ [T [v^* [V[$\mu\phi$], OBJ]]]]]
 e. [C [SUBJ [T [$\mu\phi$] [v^* [V[$\mu\phi$], OBJ]]]]]
 f. [C [SUBJ [T [$\mu\phi$] [v^* [V[$\mu\phi$], OBJ]]]]]

After the v^* P phase is formed in (17a), Feature Inheritance transmits its [$\mu\phi$] features to V in (17b).² Phasehood is also inherited by V, and VP becomes the lower phase. Thus, VP becomes invisible to further operation in (17c). Likewise, the derivation of the CP phase is shown in (17d–f). (16c) states that the effect of the phase impenetrability condition applies to the whole phase, not the complement of the phase head, and the whole TP becomes inaccessible in (17f). Hence, assumption (16c) does not change the derivation in English. However, in Japanese, without [ϕ] features, the derivation becomes different from English.

- (18) a. [v^* [V, OBJ]] (order irrelevant)
 b. [C [SUBJ [T [v^* [V, OBJ]]]]]

After the v^* P phase is formed, there is no phase lower than v^* . V is not a phase head because it constitutes a phase only when it inherits phasehood with [$\mu\phi$] features from v^* . As Japanese lacks [ϕ] features, Feature Inheritance does not occur in (18a). Thus, the whole v^* P remains accessible according to (16c). After the completion of the CP phase, the lower v^* P phase becomes inaccessible.

With these assumptions, I demonstrate the derivation of Japanese RCs. The generalization is that short RCs exhibit reconstruction, whereas long-distance RCs do not. First, (19) shows the derivation of short RCs.

- (19) [DP [RC [v^* P ... DP...]] DP]
 M-gap

² (17) shows simplified structures. I omit the object shift assumed by Chomsky (2015).

Each inscription of DP is introduced by external Merge, and Form Copy assigns an M-gap relation between them. Note that the whole v^*P phase is accessible at the phase level operations in the next phase. Therefore, the DP in the RC can enter into copy relation without movement. As the derivation involves a uniform M-gap relation, reconstruction occurs with short RCs. Next, long-distance RCs are derived as follows:



In (20), the head DP must move to the edge of the highest v^*P ; otherwise, it becomes inaccessible when the v^*P phase is formed.³ Then, Form Copy applies to the DP on the edge of v^*P and the DP base-generated outside the RC. As the derivation includes mixed relations, the interpretive systems can trace the highest M-gap relation, but not further.⁴ Hence, the highest clause sensitivity can be deduced from the interpretive rule (15).

Next, I address the issue of the base position of the head DP. I assume in (19) and (20) that the head DP is externally merged in the spell-out position. Japanese requires this option to derive RCs without a gap. Other languages also show that such a derivation is necessary.

- (21) [sakana-ga yakeru] **nioi**
fish-NOM burn smell
'the smell that a fish burns'

- (22) Equi-NP Deletion, I found Brame's arguments against *(it) very convincing.
(Radford 2018: 49)

- (23) Gianni, *(lo) ho visto.
G. him have saw
'Gianni, I saw him.'
(Italian, adapted from Cinque 1990:14)

- (24) Defoe, even I could have scored that goal.
(Radford 2018:42)

In (21), there is no gap in the RC, and the head DP must be introduced by external Merge with the clause. (22) and (23) are examples of topicalization with a resumptive pronoun. Although some researchers argue that resumptive pronouns are made by movement (for example, Boeckx 2002; see also McCloskey 2002 for the argument against it), I assume here that a certain kind of topic is externally merged with the matrix clauses, obviating the island effect in (22). (24) is an English example of topicalization without a gap, which provides a clear example of a DP merged externally with a clause.

They seem to be contrary to Duality of Semantics (9), according to which the discourse-

³ Note that internal Merge to the edge of CP is not sufficient. After the completion of the v^*P phase, the whole CP phase, including its spec, becomes inaccessible.

⁴ If DP with the RC moves in the matrix clause, (15) does not preclude the reconstruction of the head DP into the highest clause of the RC because the internal Merge and copy calculation in the matrix clause target DP with the RC, not DP itself. The head DP can reconstruct into the highest clause according to the M-gap relation, and the head DP with the RC can reconstruct according to its movement relation.

oriented information is given by internal Merge. However, it is a generalization, not an established principle, and if so, the deviation from it is not a severe problem. Duality of Semantics has two parts: external Merge explains the theta-roles, and internal Merge the discourse-related properties. I speculate that the first half can be deduced from (s-)selection and Full Interpretation. Without a theta-role, DP has no contribution to the event that the sentence expresses, and it violates Full Interpretation. When DP merges externally with the predicate, it receives a theta-role and also satisfies Full Interpretation. Thus, external Merge to a theta-position is a way to satisfy Full Interpretation.⁵ The latter half of Duality of Semantics is based on semantics. As semantics requires an operator-variable configuration for *wh* interrogatives or the focus interpretation, internal Merge must be used. This decomposition of Duality of Semantics allows DP to merge externally with a clause, as long as Full Interpretation is satisfied. I assume that the following interpretive rule works:

(25) DP externally merged with a clause is interpreted as a topic. (cf. Murasugi (2020))

According to (25), DP can receive a semantic role *TOPIC* by external Merge with a clause. It behaves like a theta-role in that Form Copy assigns an M-gap relation between DP with *TOPIC* and DP with a theta-role. A semantic role assigned to DP must be *TOPIC*, not *FOCUS* or *INTERROGATIVE*, given that the focus and interrogative interpretations require operator-variable configurations produced by internal Merge.⁶ The assumption assigns DP in (21–24) topic interpretation and exempts them from Duality of Semantics because they can satisfy Full Interpretation. Moreover, the assumption also accounts for the similarity between topics and RCs in Japanese (Kuno 1973). Kuno observes the parallelism between the DP topics and relativizability.

(26) a. Mary-ga John-to benkyoosita.

M.-NOM J.-with study.did

‘Mary studied with John.’

(adapted from Kuno 1973: 245)

b. John-to-wa Mary-ga benkyoosita.

J.-with-TOP M.-NOM study.did

‘With John, Mary studied.’

(adapted from Kuno 1973: 245)

5 Univocality of theta-roles, by which Chomsky (2021) precludes internal Merge to a theta-position, remains to be explained. However, if the derivation does not store the history, as Chomsky argues, the system may not care about the types of Merge; syntax just formulates the structure and the interpretive systems assign interpretation to it according to its representation. This idea can erase the dichotomy of external/internal Merge with the following interpretive rules:

(i) a. If two identical objects have theta-roles (or the corresponding semantic role like *TOPIC*, see the discussion below), the copy relation between them is an M-gap.

b. If either one of the two identical objects has a theta-role, the copy relation is a traditional copy relation.

(i) does not resort to the types of Merge to distinguish the two relations. According to this idea, the interpretive systems can only see the representation of the structure. Therefore, in (ii), the higher inscription of *John* may merge externally or internally. Regardless of the operation, the copy relation is identified as an M-gap according to (ia) at the phase level.

(ii) John tried John to win.

6 Here, I refer to the aboutness topic, not the contrastive topic because the contrastive topic also requires operator-variable configuration and internal Merge.

- c. *John-wa Mary-ga benkyoosita.
J.-TOP M.-NOM study.did
'John, Mary studied (with).'
- (adapted from Kuno 1973: 245)
- d. *Mary-ga benkyoosita **John**
M.-NOM study.did J.
'John, with whom Mary studied'
- (adapted from Kuno 1973: 245)
- (27) a. Mary-ga John-to issyoni benkyoosita.
M.-NOM J.-with together study.did
'Mary studied together with John.'
- (adapted from Kuno 1973: 245)
- b. John-to-wa Mary-ga issyoni benkyoosita.
J.-with-TOP M.-nom together study.did
'With John, Mary studied together.'
- (adapted from Kuno 1973: 245)
- c. John-wa Mary-ga issyoni benkyoosita.
J.-TOP M.-NOM together study.did
'John, Mary studied (with) together.'
- (adapted from Kuno 1973: 245)
- d. Mary-ga issyoni benkyoosita **John**
M.-NOM together study.did J.
'John, (with whom) Mary studied together'
- (adapted from Kuno 1973: 246)

(26b, c) are derived from (26a) by topicalization. Although the PP topic in (26b) is well-formed, the DP topic in (26c) is not.⁷ In this case, the RC in (26d) is also ill-formed. (27a–d) are the same with (26a–d) except for the additional *issyoni* 'together'. In this case, the DP topic in (27c) is well-formed, as well as the PP topic in (27b), and relativization is possible in (27d). This parallelism is captured by the same derivation between DP topicalization and relativization in the proposed framework. In both constructions, DP merges externally with clauses. The only difference is that Form Copy applies in RCs.

Let us consider the following derivation for a long-distance RC again with the assumptions above:

- (28) [DP [RC ...DP[θ] [...~~DP[θ]~~...]] DP[TOP]]

DP base-generated in the RC receives a theta-role from a predicate and moves to the phase edge. Subsequently, another inscription of DP merges externally with the RC, receiving a semantic role TOPIC. Finally, Form Copy assigns the copy relation to them. As both of them have the theta-/semantic-roles assigned by external Merge, the relation is interpreted as an M-gap.

Finally, I touch on other RCs in Japanese. It is well-known that Japanese allows relativization from an island.

- (29) [[sinsi yoofuku kiteiru] yoofuku]-ga yogoreteiru] **sinsi**
gentleman clothes wearing clothes-NOM dirty gentleman
'a gentleman who the clothes that (he) is wearing is dirty'

⁷ Kuno derives (26c) using the deletion of the particle from (26b).

In (29), the head DP *sinsi* ‘gentleman’ is relativized out of the underlined RC. (30) is a long-distance RC of this type.

- (30) Taro-ga [[[sinsi yoofuku kiteiru] yoofuku]-ga yogoreteiru]-to omotteiru]
 T.-NOM gentleman clothes wearing clothes-NOM dirty-C thinking
sinsi
 gentleman
 ‘a gentleman who Taro thinks the clothes that (he) is wearing is dirty’

In the proposed analysis, the head DP in the RC must move to the position visible from the head DP outside the RC. In (29), the head DP must move to the spec of the highest v^*P ; otherwise, it becomes invisible when the v^*P phase is formed. However, such movement is precluded because of the complex NP island. Therefore, I assume that (29) and (30) are derived by *pro*.

- (31) [DP [RC ...[island ...*pro*...]...] DP]

In (31), DP merges with a clause that contains a *pro* referring to the head DP. There is no copy relation here because DP and *pro* are separated by a phase; Form Copy cannot locate DP and *pro* in one phase. Thus, (30) is like the gapless RC (21) in its nature.⁸ (32) shows a summary of the types of RCs and their derivations.

(32)

| | short RC | long-distance RC | RC from island |
|-----------------------|----------|------------------|---------------------------|
| previous analyses | movement | <i>pro</i> | <i>pro</i> |
| the proposed analysis | M-gap | M-gap | complex NP (<i>pro</i>) |

Previous analyses put long-distance RCs and RCs from islands into one group in that they depend on *pro*. In contrast, I propose that short and long-distance RCs are derived the same way and RCs from islands are complex NPs like gapless RCs. In all three types of RCs, the head DP is base-generated outside the RC and merges externally with the RC, receiving the topic interpretation.

4. Concluding Remarks

This paper discusses reconstruction in Japanese RCs. Unlike English RCs, the head of Japanese RCs only reconstruct into the highest clause. This property, called the highest clause sensitivity, leads researchers to assign different derivations to short RCs and long-distance RCs. I account for the property from Chomsky’s (2021) Form Copy and propose a unified analysis of short/long-distance RCs. I argue that Japanese RCs are derived using the M-gap relation, and the different behavior between short and long-distance RCs comes from the interpretive rule that the interpretive systems can only trace the uniform operation. In short RCs, DP in the RC can have the M-gap relation with the base-generated head outside the RC without movement, given that a phase makes the lower phase inaccessible to further operation. In contrast, long-distance RCs involve additional movement of the head DP to escape the inaccessible domain.

⁸ Murasugi (2000) suggests that all types of Japanese RCs may be pure complex NP like (31).

Thus, the operations are mixed, and reconstruction is allowed only to the highest M-gap relation. Finally, I have reconsidered Duality of Semantics and proposed the interpretive rule that external Merge of DP with a clause assigns the DP the topic interpretation. This assumption has derived base-generated topics and gapless RCs.

References

- Boeckx, Cedric. 2002. Resumption and Asymmetric Derivation. In *Asymmetry in Grammar*. Vol. 1, *Syntax and Semantics*, ed. by Anna Maria di Sciullo, 85–98. Amsterdam/Philadelphia: John Benjamins.
- Chomsky, Noam. 1981. *Lectures on Government and Binding*. Dordrecht: Foris.
- Chomsky, Noam. 2000. Minimalist Inquiries: The Framework. In *Step by Step: Essays on Minimalist Syntax in Honor of Howard Lasnik*, ed. by Roger Martin, David Michaels, and Juan Uriagereka, 89–155. Cambridge, MA: MIT Press.
- Chomsky, Noam. 2008. On Phases. In *Foundational Issues in Linguistic Theory*, ed. by Robert Freidin, Carlos P. Otero, and Maria L. Zubizarreta, 133–166. Cambridge, MA: MIT Press.
- Chomsky, Noam. 2015. Problems of Projection: Extensions. In *Structures, Strategies and Beyond: Studies in Honour of Adriana Belletti*, ed. by Domenico, Elisa, Cornelia Hamann, and Simon Matteini, 3–16. Amsterdam/Philadelphia: John Benjamins.
- Chomsky, Noam. 2021. Minimalism: Where Are we Now, and Where Can we Hope to Go. *Gengo Kenkyu* 160: 1–41.
- Cinque, Guglielmo. 1990. *Types of \bar{A} -Dependencies*. Cambridge, MA: MIT Press.
- Ishii, Yasuo. 1991. Operators and Empty Categories in Japanese. Doctoral dissertation, The University of Connecticut.
- Kayne, Richard. 1994. *The Antisymmetry of Syntax*. Cambridge, MA: MIT Press.
- Kizu, Mika. 2005. *Cleft Constructions in Japanese Syntax*. New York: Palgrave Macmillan.
- Kuno, Susumu. 1973. *The Structure of the Japanese Language*. Cambridge, MA: MIT Press.
- McCloskey, James. 2002. Resumption, Successive Cyclicity, and the Locality of Operations. In *Derivation in the Minimalist Program*, ed. by Samuel David Epstein and T. Daniel Seely, 184–226. Oxford: Blackwell.
- Miyamoto, Yoichi. 2017. Relative Clauses. In *Handbook of Japanese Syntax*, ed. by Masayoshi Shibatani, Shigeru Miyagawa, and Hisashi Noda, 611–634. Berlin: Mouton de Gruyter.
- Murasugi, Keiko. 2000. An Antisymmetry Analysis of Japanese Relative Clauses. In *The Syntax of Relative Clauses*, ed. by Artemis Alexiadou, Paul Law, André Meinunger, and Chris Wilder, 231–263. Amsterdam/Philadelphia: John Benjamins.
- Murasugi, Keiko. 2020. Parameterization in Labeling: Evidence from Child Language. *The Linguistic Review* 37: 147–172.
- Radford, Andrew. 2018. *Colloquial English*. Cambridge: Cambridge University Press.
- Saito, Mamoru. 2017. A Note on Transfer Domains. *Nanzan Linguistics* 12: 61–69.
- Schachter, Paul. 1973. Focus and Relativization. *Language* 49: 19–46.
- Vergnaud, Jean-Roger. 1974. French Relative Clauses. Doctoral dissertation, MIT.

The global licensing of Japanese expletive negation*

Shun Ihara

Kobe University

1. Introduction

Expletive Negation (or Evaluative Negation, henceforth “EN”) is the cross-linguistically attested form/meaning mismatch whereby a negation does not contribute the standard (i.e., truth-conditional) negative meaning (See Yoon (2011) and references therein for EN across languages). Although not all languages share all the environments, cross-linguistically EN is known to occur in certain embedded or subordinated contexts that express uncertainty or non-veridicality, for instance, negative priority attitude predicates expressing e.g., ‘apprehension’ or ‘doubt’, positive priority attitude predicates expressing e.g., ‘hope’ or ‘wish’, *before/until/unless*-clauses, or comparative clauses. While varieties of proposals are posited to give an account for these facts, with few exceptions on EN in exclamatives (Portner & Zanuttini 2000, Delfitto & Fiorin 2014), almost all studies on EN have been focused on embedded/subordinated environments as exemplified above.

In this paper, we will focus on EN in the matrix environments, showing previously undiscussed facts that EN in Japanese can appear in certain directive (or command) constructions. In (1), remarkably, the negation *nai* ‘not’ can only be interpreted expletively (i.e., positively) and disallows the standard negation (henceforth “SN”) (i.e., negative) interpretation, as suggested in the translations.

- (1) a. Hayaku aruka **nai** ka!
 quickly walk NEG Q
 ‘Walk quickly!’ [EN-interpretation]/#‘Don’t walk quickly!’ [SN-interpretation]
- b. Osake-o yame **nai** ka!
 alcohol-ACC stop NEG Q
 ‘Stop drinking alcohol!’/#‘Don’t stop drinking alcohol!’

It is worth noting that despite the fact that the sentences in (1) have the question particle *ka*, they cannot be understood as questions and are constrained to have the directive meaning. To the best of my knowledge, EN in directive sentences has not been attested in the literature.¹

As we will observe later in detail, what is more intriguing and puzzling about EN in Japanese is that they cannot be licensed if the particle *ka* does not arise, even though the sentences are still interpreted as directives.

* I would like to thank the audience of GLOW in Asia XIII Online Special for their useful comments, especially Željko Bošković and Hiromune Oda, as well as audiences at the workshop “Aspects of Negation, Polarity, and *Koto*” where the previous version of the paper were presented. This work has been supported by JSPS KAKENHI (Grant Number 21K13000). All remaining errors are entirely my own.

¹One may doubt that such type of *nai* is expletive negation. For reasons of space, we omit the data, but the evidence that such *nai* is expletive includes, for example, the followings: (i) expletive *nai* allows the “literal” interpretation when co-occurs with minimizer NPIs (negative polarity items), (ii) sentences with expletive *nai* licenses PPIs (positive polarity items), and (iii) expletive *nai* cannot receive prosodic marking (cf. Yoon 2013).

- (2) a. Hayaku aruka **nai!**
 quickly walk NEG
 #‘Walk quickly!’/‘Don’t walk quickly!’
- b. Osake-o yame **nai!**
 alcohol-ACC stop NEG
 #‘Stop drinking alcohol!’/‘Don’t stop drinking!’

Given the basic facts, the core research questions in this paper are: (i) what is the distribution of the occurrence of expletive *nai* in matrix contexts? (ii) What is the licensing condition governing the distribution? (iii) What is the semantic/pragmatic contribution of expletive *nai*? In other words, how is the entire directive meaning of sentences with expletive *nai* derived compositionally? The aim of this paper is to give answers to these questions by offering a unified account for the distribution of expletive *nai* in both embedded and matrix contexts. Speech-acts other than directives such as exclamatives and rhetorical questions will also be in the empirical scope of the analysis. Pointing out that widely accepted theories of EN based on uncertainty/non-veridicality fail to predict the distribution, I claim that uncertainty/non-veridicality is not the only licenser of EN, but the notion of triviality in discourse commitments is further needed.

2. The landscape of expletive *nai* in the matrix contexts

Yoon (2011; 2013) observes that in parallel with Korean EN, Japanese EN can occur with positive attitude predicates as well as negative predicates. For Yoon, this is the crucial motivation that distinguishes EN in Korean and Japanese from those in Old/Middle English, French, Polish, Russian, Catalan, etc. The relevant data is shown in (3).

- (3) a. John-wa Mary-ga ko-**nai**-ka (to) **osore**-tei-ru.
 John-TOP Mary-NOM come-NEG-Q COMP fear-PROG-PRS
 ‘John fears that Mary might come.’ [negative predicate]
- b. John-wa Mary-ga ko-**nai**-ka (to) **kitaishi**-tei-ru.
 John-TOP Mary-NOM come-NEG-Q COMP hope-PROG-PRS
 ‘John hopes that Mary might come.’ [positive predicate]

Let us now turn to see the matrix cases. As we have seen in the earlier examples in (1) and (2), whether the particle *ka* occurs sentence-finally is one crucial factor of licensing EN-interpretation. This, however, is not the whole story. *Nai* can have EN-interpretation when the sentence is followed by rising (or questioning) intonation (abbreviated as “?” in examples), even without *ka*. In contrast, if the intonation accompanied is falling (non-rising) intonation (abbreviated as “!” or “.”), EN-interpretation is impossible.²

- (4) a. Hayaku aruka **nai ?**
 quickly walk NEG
 ‘Walk quickly?’ [w/ ?, w/o *ka*]

²Throughout this paper, examples with a question mark “?” are to be read as accompanied by the LH% (questioning rise) tune, examples with an exclamation mark “!” are to be read as accompanied by the H% (insisting rise) tune, and examples with a period “.” are to be read as the absence of intonation label (or the “flat” tune).

- b. Hayaku aruka **nai** !
 quickly walk NEG
 #‘Walk quickly!’/‘Don’t walk quickly!’ [w/o ?, w/o *ka*]

As indicated by the translation in (4a), the sentence with rising intonation sounds much more tentative/suggesty than the one with *ka* and falling intonation in (1a) (and (5b) below), conveying the effect similar to *rising imperatives* in English (Rudin 2018). Intuitively speaking, the speaker in (4a) seems to be instructing the addressee to walk quickly instead of obliging her to do so. One important difference between (4a) and English rising imperatives is that the former must encode the speaker’s preference toward the proposition while the latter can be free from the speaker’s preference. I will return to this issue in Section 4.

As shown in (5), the sentences with *ka* can obtain EN-interpretation regardless of whether rising intonation is followed or not.

- (5) a. Hayaku aruka **nai ka** ?
 quickly walk NEG Q
 ‘Walk quickly?’ [w/ ?, w/ *ka*]
 b. Hayaku aruka **nai ka** !
 quickly walk NEG Q
 ‘Walk quickly!’ [w/o ?, w/ *ka*]

In sum, the observation so far indicates that *nai* can be expletive either (i) when the sentence is accompanied by rising intonation or (ii) when the particle *ka* attaches to the proposition.

Before discussing how the distribution here is theoretically puzzling, one more empirical fact needs to be added. Besides the directive interpretation, a sentence with *ka* without rising intonation can have an assertive-like interpretation, as shown in (6) (cf. (5b)). In this case, even with *ka*, the sentence is not allowed to have EN-interpretation.

- (6) [Context: the speaker steps on an accelerator of a motorcycle whose engine has failed.]
 Yappari hashira **nai ka**.
 after.all run NEG Q
 #‘I knew it (= the motorcycle) would work.’/‘I knew it would **not** work.’ [w/o ?, w/ *ka*, assertive]

The distribution of expletive *nai* in matrix environments is summarized in the Table below.

| | with <i>ka</i> | without <i>ka</i> |
|---------------------------|----------------------|-------------------|
| with rising intonation | ✓ | ✓ |
| without rising intonation | ✓ but # in assertion | # |

Table 1: Licensing of expletive *nai* in matrix contexts

3. Previous approach: EN as a subjunctive mood marker

3.1 Yoon (2011;2013)

Among the many proposals (cf. Mari & Tahar (2020, Sec. 2) and references therein), this section examines Yoon’s (2011; 2013) account, which is the only formal study that addresses Japanese EN.

Departing from the view that EN plays the role of a standard negation (e.g., Abels 2002, Roguska 2007, Delfitto et al. 2019) or of a negative concord item (Zeijlstra 2004, Espinal 2007), Yoon (2011; 2013) proposes that EN in Japanese and Korean is semantically a *subjunctive mood marker*. In the line of Giannakidou (2009), she assumes that (i) the subjunctive mood is licensed by non-veridical/uncertainty predicates and (ii) does not actively contribute to meaning but encodes a certain condition that restricts its distribution to the scope of nonveridical predicates. Specifically, she argues that the contribution of EN is to convey a scalar/evaluative meaning as in (7b). According to her analysis, while EN in Old/Middle English, French, Polish, Russian, Catalan, etc. imposes an ordering on the modal base “**mb**” of embedding predicates w.r.t. a *desirability* scale, EN in Japanese and Korean imposes an ordering on **mb** w.r.t. an *unlikelihood* scale, given the fact that EN in the latter languages can occur with positive predicates (e.g., *hope*).

(7) *Scalar semantics for EN with ‘hope’* (Yoon 2011; 2013):

- a. If **hope**(x,p) is true in a context c , then **mb**(x) \cap p is not \emptyset in c .
- b. The evaluative component of EN(x,p) expresses in c as the following:

$$[\mathbf{mb}(x) - p] \text{ } >_{\text{likely}} \text{ } [\mathbf{mb}(x) \cap p] \text{ in } c$$

The truth condition of *hope* is that ‘ x hopes p ’ simply requires that there is some world w in **mb**(x) that is also a p -world, as given in (7a). Then, as shown in (7b), the evaluative component of EN expresses that the probability of p is low, given what the epistemic subject knows.

3.2 Puzzle

In line with Yoon (2011; 2013), the analysis in this study will maintain the idea that EN can be licensed by non-veridicality, but I will show that some of the assumptions behind her analysis should be abandoned, considering over- and under-generation problems.

First, the analysis that EN is licensed by non-veridical/uncertainty predicates cannot capture the licensing of expletive *nai* in the matrix contexts where no non-veridical predicate arises. To give a unified account for both embedded and matrix cases we should rather assume that it is a non-factive complementizer *ka* that triggers EN-interpretation of *nai* independently, even in embedded cases (See Mizuno (2021) for this line of analysis).³ I will discuss this more precisely in Section 4, but for the sake of discussion, let me assume that elements that exhibit non-veridicality (including *ka*) can be a licenser of expletive *nai* when they scope over *nai*.

Assuming that *ka* plays a role as a licenser of expletive *nai* by itself, it is predicted that *nai* can have expletive interpretation when co-occurs with *ka*, even in matrix contexts. This prediction seems to be borne out in the cases where utterances with *ka* are interpreted as directives or suggestions, as we have observed in the example (5). However, at the same time we also know that this is not always the case, because in the case where utterances with *ka* are interpreted as assertions (cf. (6)), *nai* cannot obtain EN-interpretation.

The non-veridicality-based analysis moreover would predict that *nai* in the matrix can be expletive when uttered with speech-acts that mark non-veridicality. That is, if elements that

³This seems to be correct, given the fact that without *ka*, embedded *nai* cannot be expletive even when embedded by non-veridical predicates. (See also Example (51) in Mizuno (2021).)

(i) John-wa Mary-ga ko-**nai** to **kitaisi**-tei-ru.
 John-TOP Mary-NOM come-NEG COMP hope-PROG-PRS
 ‘John hopes that Mary might **not** come.’ (#‘John hopes that Mary might come.’)

exhibit non-veridicality can trigger the meaning of EN, then speech-acts conveying non-veridicality must also be a licenser of EN. This indeed holds true of *nai* in information-seeking questions that exhibit non-veridicality (by definition). Sudo (2013) observes that *nai* as EN can occur in questions with certain types of positive bias.⁴ In (8), *dokoka* ‘somewhere’ is a PPI and ensures that *nai* is construed as EN, not as SN.

(8) A: (Looking at a guidebook) There are all sorts of restaurants around here.

B: Dokoka nihon-shoku nai?
 somewhere Japanese-food NEG
 ‘Isn’t there some Japanese restaurant?’

(Sudo 2013: (23))

However, the analysis over generates the use of *nai* in directive speech-acts. Kaufmann (2012) among others (e.g., Condoravdi & Lauer 2012) assumes that directive-type speech acts (including command, suggestion, invitation, etc.) mark non-veridicality as the felicity condition, in the sense that a directive utterance ‘*Dir(p)*’ presupposes both *p* and $\neg p$ are possible. This will make a prediction that *nai* in a directive sentence ‘*Dir(nai(p))*’ can have expletive interpretation, contrary to the fact that only *nai* in the sentence with rising intonation or with *ka* can be EN (cf. (4a), (5a,b)), while *nai* in the sentence without both *ka* and rising intonation cannot (cf. (4b)).

To summarize, the analysis based on non-veridicality is suitable to explain the data with *ka* in directives but falls short to capture (i) the data with *ka* in assertion interpretation and (ii) the data which lacks both *ka* and rising intonation. My analysis to be proposed in the next section allows us to explain the data in question, maintaining the idea that *ka* as a non-veridical marker can be a licenser of EN.

4. Proposal

4.1 Ingredients

This study makes use of the dynamic discourse model known as the *Table(-stack) model* initially developed by Farkas & Bruce (2010). In this model, assertions are not considered as contributing direct updates of the Common Ground (CG) but are analyzed as contributing proposals to update this set, in which the speaker takes on a public discourse commitment and projects the future CG. Since not all of the discourse components of this model are useful for the purpose, I just introduce relevant components in a context *K*:

(9) A discourse context $K_n = \langle A_n, DC_n, T_n, CG_n, PS_n \rangle$, where:

- a. *Common Ground (CG)*: The set of all propositions that all discourse participants $a \in A_n$ are mutually committed to.
- b. *Discourse Commitments (DC)*: For all discourse participants $a \in A_n$, there is a set DC_a of propositions that a has committed to. (to be refined)
- c. *The Table (T)*: A stack of *issues* (sets of propositions), the uppermost (i.e., maximal) element of which ($\mathbf{max}(T)$) is currently at issue.
- d. *The Projected Set (PS)*: The set of all CGs that could result by adding an element of $\mathbf{max}(T)$ to the current CG (intuitively, the *future CG*), $PS_n = \{ CG_n + p : p \in \mathbf{max}(T) \}$.

⁴Note that Sudo (2013) refers to such *nai* as “outside” negation, not as “expletive” negation. The bias carried in (8) is e.g., the questioner wants to go to a good restaurant and to a Japanese restaurant respectively.

Formally, an assertion of a sentence denoting a proposition p , $\text{ASSERT}(p)$, is defined as a function from contexts (K) to contexts (K') of the following form.

(10) $[[\text{ASSERT}(p)]] = \lambda p. \lambda K. K'$ such that:

- a. $DC_{K',sp} = DC_{K,sp} + p$
- b. $T_{K'} = T_K + \{p\}$
- c. $PS_{K'} = \{ CG_K + p \}$
- d. In all other respect, $K' = K$.

More intuitively, an assertion returns a context such that (a) the speaker makes discourse commitment to p , (b) the current issue of the discourse is p , and (c) the speaker expects that the addressee will also be committed to p . Crucially, in Farkas & Bruce, all components of the model are modally unified. They are to be interpreted epistemically or doxastically. Specifically, the propositions in the Table are those currently under consideration as potential mutual epistemic/doxastic commitments, and the projected set represents what it would look like if those potential mutual doxastic commitments were made.

Following Rudin (2018), I further assume the extended version of the Table model, which allows us to analyze directive speech-acts. Rudin proposes a programmatic extension of the Table model that bifurcates it into doxastic and teleological halves, identical to each other except in terms of the modal interpretation of their components. The doxastic half of the model is identical to the standard model introduced above. He proposes that directives do exactly the same thing that standard assertions do, except that they interact with what he calls the teleological discourse commitment in (11). Following Condoravdi & Lauer (2012), he assumes that the modality relevant to the teleological commitment is effective preferences. The core idea of the effective preference is that, intuitively, imperatives encode the speaker's preference which is ordered with respect to other preferences. The realism condition in (12) ensures that teleological discourse commitments are required to be both consistent and realistic.⁵

(11) *Discourse Commitments* (bifurcated version):

For all discourse participants $a \in A_n$, $DC_a = \langle DC_{dox,a}, DC_{tel,a} \rangle$, where:

- a. $DC_{dox,a}$ (doxastic commitment) is a set of propositions that a is publicly committed to acting as though she believes, and
- b. $DC_{tel,a}$ (teleological commitment) is a set of propositions that a is publicly committed to acting as though she has an effective preference for. (Rudin 2018: (33))

(12) *Realism condition*:

For any $a \in A_n$, $\forall p: p \in DC_{tel,a} \cdot p \cap \bigcap DC_{dox,a} \neq \text{empty}$. (ibid.: (34))

Directives are then interpreted as having a discourse move in (13). The only difference with assertions is that they interact with teleological half of the discourse commitment.

(13) $[[\text{DIR}(p)]] = \lambda p. \lambda K. K'$ such that:

- a. $DC_{K',tel,sp} = DC_{K,tel,sp} + p$
- b. $T_{K'} = T_K + \{p\}$
- c. $PS_{K'} = \{ CG_K + p \}$
- d. In all other respect, $K' = K$.

⁵Rudin also proposes to bifurcate the common ground, the table, and the projected set in the same way as the discourse commitment, respectively as follows: the teleological common ground CG_{tel} is the set of all propositions that all interlocutors are publicly committed to having an effective preference for, the teleological Table T_{tel} hosts content under consideration for incorporation into CG_{tel} , and the teleological projected set PS_{tel} contains a set of possible future CG_{tel} , one incorporating each element of $\mathbf{max}(T_{tel})$.

Intuitively, a directive updates a context K by (a) adding p to the speaker's DC_{tel} in K , (b) adding an issue $\{p\}$ to the Table, and (c) the speaker expects that the addressee will accept the content expressed by p .

Finally, following Truckenbrodt (2006) and Rudin (2018), rising intonation “ $\uparrow?$ ” applies to a function from contexts to contexts and overrides speaker commitment.

(14) Let \mathbf{C} be an abbreviation for a function from contexts to contexts.

[[$\uparrow?$]] = $\lambda\mathbf{C}.\lambda K.K'$ such that:

- a. $DC_{K',sp} = DC_{K,sp}$ b. In all other respect, $K' = \mathbf{C}(K)$.

Informally speaking, the meaning of (14) is that rising intonation signals that the speaker is making *no* discourse commitments by virtue of their utterance.

4.2 Global licensing of EN

Let me now turn to the proposal in this paper. I propose that Japanese EN can be licensed globally by the speaker's *trivial commitment*, not only by uncertainty/non-veridicality markers semantically and locally. Technically, *nai* can be interpreted as EN when an utterance ‘ $Utt(p)$ ’ in K is marked by certain phonologically non-null elements (e.g., particles, intonation, etc.) that lead to an update which results in an output context K' that contains $DC_{K'}$ which is identical with DC_K . Whether the commitment should be doxastically or teleologically trivial is determined by the associated speech act; in assertions, DC should be DC_{dox} and in directives, the set should be DC_{tel} . Intuitively, when the speaker uttering $Utt(p)$ is not committed to the truth of p or $\neg p$ either doxastically or teleologically by virtue of that utterance, the matrix *nai* can be EN. I define the notion of triviality as in (15) (cf. Malamud & Stephenson 2015).

(15) *Trivial discourse commitment*:

A regular discourse commitment made by an utterance $Utt(p)$ in a context K is *trivial* if and only if the output context K' contains $DC_{K'}$ s.t. $DC_{K'} = DC_K$.

Note that the term “commitment” in (15) refers to “regular” discourse commitments, not *projected commitments* proposed by Malamud & Stephenson (2015), which simply represents the expected next stage of discourse commitments, just like the projected CGs.⁶

Let us derive the distribution of expletive *nai* in matrix environments. First, the proposal captures the contrast between sentences [w/?, w/o *ka*] and sentences [w/o ?, w/o *ka*] as follows. The example (4a) contributes to the discourse move (16), where the issue $\{p\}$ is added to the Table but is not added to the output $DC_{tel,sp}$, thanks to the effect of rising intonation. The commitment is therefore made trivial by the utterance, thus licensing expletive *nai*.

⁶ Note also that Yoon (2011; 2013) also proposes the licensing condition of EN in Japanese and Korean in terms of lack of “commitment.” However, she uses the term “commitment” to mean only epistemic/doxastic commitments, ignoring teleological/deontic commitments.

(16) The discourse move of (4a) = “*Hayaku aruka nai?*” ‘Walk quickly?’

| | Before (4a) | After (4a) |
|-----------------|-------------|------------|
| $DC_{tel,spkr}$ | { } | { } |
| T | { } | {{ p }} |
| CG | { } | { } |
| PS | { } | {{ p }} |

p = ‘the addressee walks quickly’

(4b) is a case where both rising intonation and *ka* do not occur. Here, as shown in (17), since the directive sentence raises the issue { p } and crucially adds p to $DC_{tel,sp}$, the move results in a non-trivial update, unlike the previous case in (16). In (4b), no other elements that can license expletive *nai* arises in the sentence, hence only the SN-interpretation is allowed.

(17) The discourse move of (4b) = “*Hayaku aruka nai!*” ‘Don’t walk quickly!’

| | Before (4b) | After (4b) |
|-----------------|-------------|------------|
| $DC_{tel,spkr}$ | { } | { p } |
| T | { } | {{ p }} |
| CG | { } | { } |
| PS | { } | {{ p }} |

p = ‘the addressee does **not** walk quickly’

Next consider the cases where *ka* occurs sentence-finally. In this paper, we maintain the idea of Yoon (2011; 2013) that *ka* as a non-veridicality/uncertainty marker locally (i.e., semantically) licenses expletive *nai* as a subjunctive mood marker. The idea explains the data in (5) as follows. In the example (5a) where both *ka* and rising intonation occur, there are two possibilities and either way is fine: *nai* can be licensed either by *ka* locally or by triviality of discourse commitment made by rising intonation. As for (5b), although *nai* cannot be licensed globally because of lack of rising intonation, (which leads to a discourse move identical with (4b) in (17b) except for the polarity of p), it can obtain EN-interpretation via local licensing by *ka*. This means that for EN in matrix contexts, global licensing is not the only way to license it, and local licensing remains possible strategy of EN-licensing.

It should be noted that it is not empirically and theoretically tailor-made that for expletive *nai* there can be two ways to license it. First, while local licensing of *nai* (by *ka*) induces an obligatory EN-reading, global licensing (by rising intonation) induces a non-obligatory EN-reading. The data in (18) (= (4a)) indicates that when only rising intonation occurs (i.e., only the global licensing is possible), the sentences allow both SN and EN-interpretation. On the other hand, in (19), the sentences with *ka* are obliged to have EN-interpretation regardless of whether it is embedded (= (19c)) or not (= (19a,b)).

(18) “*Hayaku aruka nai?*” ‘Walk quickly?’ or ‘Don’t you walk quickly?’ [EN: ok / SN: ok]

- (19) a. “*Hayaku aruka nai ka?*” (= (5a)) Only: ‘Walk quickly?’ [EN: ok / SN: #]
 b. “*Hayaku aruka nai ka!*” (= (5b)) Only: ‘Walk quickly!’ [EN: ok / SN: #]
 c. “*John-wa Mary-ga ko-nai ka kitaishi-teiru.*” (= (3a))
 Only: ‘John hopes that Mary might come.’ [EN: ok / SN: #]

The contrast suggests that we should distinguish between the two ways of EN-licensing in terms of their strength of licensing: while *ka* as a local (semantic) licenser is strong in the sense that it contributes to mandatory licensing, trivial commitment as a global (pragmatic) licenser is relatively weak in terms of obligatoriness of EN-licensing.

Theoretically, two types of licensing are not EN-specific and are attested in NPIs. Sedivy (1990) (cf. Sailer 2021) argue that two types of licensing is needed to explain the difference between weak NPIs such as *ever* and minimizer NPI such as *lift a finger*, building on the observation that unlike weak NPIs, minimizer NPIs can occur both in semantically negated sentences and in cases with pragmatic “negative side message”: Type1 licensing for weak NPIs is a regular semantic one which is only with respect to the semantics of the sentence, and Type 2 licensing for minimizer NPIs is with respect to some pragmatic inferred statement (e.g., contrastive focus) in addition to the semantic one. That is, minimizer NPIs can be licensed by both semantic and pragmatic content. A discussion of why elements such as minimizer NPI and certain EN are licensed in two different environments and what universality lies behind them is beyond the scope of this paper, but at least I emphasize that the fact that Japanese *nai*, like minimizer NPI, allows licensing from both semantics and pragmatics is in itself not exceptionally special phenomenon.

Then, why cannot the directive operator (which also employs subjunctive mood like *ka*) license EN semantically? More cross-linguistic investigation is needed to give an answer to this question, but one possibility is that this is because the directive operator is only an abstract speech-act operator which is phonologically unmarked, unlike rising intonation or *ka*. In Japanese, even an imperative morphology (e.g., *e/ro* for positive imperatives and *na* for negative imperatives) does not mark the directivity by itself but encodes only a necessity modal meaning (Ihara 2021). As expected, Japanese negative morphology *na* (which encodes a meaning almost identical with ‘□¬’) cannot obtain EN-interpretation, assuming that in (20) the directive operator scopes higher than *na*, $\text{DIR}(na(p))$.⁷

- (20) Hayaku ik-u **na**.
 quickly go-PRS NEG.IMP
 ‘Don’t you walk quickly!’/#‘Walk quickly!’

In Yoon’s analysis, non-factive complementizers including *ka* as a subjunctive mood marker can be a locus of the evaluative feature [+eval]. Assuming that only a phonologically marked element can be a locus of the feature, the directive operator cannot employ this feature and hence cannot be a semantic licenser of EN regardless of its subjunctive property.

Why is, then, the global approach required? Why can’t we say that, like Yoon, sentences without *ka* and rising intonation are just cases where there is no local EN-licenser? In Section 5, I will show that, as a further empirical motivation of the global licensing proposal, an occurrence of a possible licenser (i.e., *ka* or rising intonation) itself cannot always ensure licensing of expletive *nai*.

4.3 Interpretation

This subsection illustrates how the meanings of the sentences with EN are conveyed compositionally. I will answer to the question “How do sentences with expletive *nai* lead to

⁷Morphologically, *nai* cannot attach to positive imperative morphologies: *ik-e-nai* ‘go-IMP-NEG’ and *shi-ro-nai* ‘do-IMP-NEG’ are both ungrammatical.

the interpretation like rising imperatives or directives, crucially without having imperative forms?”. In doing so, I assume that expletive *nai* is a subjunctive marker (Yoon 2011; 2013) and that it conveys a positive epistemic/doxastic or teleological/bouletic bias toward an uttered proposition (Sudo 2013).⁸

Following Yoon’s (2011; 2013) proposal, I assume that the core contribution of expletive *nai* is to impose a negative evaluative meaning based on epistemic likelihood, namely unlikelihood (See Section 3.2). This, however, is not sufficient for the main data in this paper, because unlikelihood toward the proposition is not conveyed when expletive *nai* is used in directive/suggestive utterances, as shown in (21), where apparently the addressee is likely to go out.

- (21) [Context: The speaker sees the addressee is ready to go out.]
Hayaku ika nai ka! / *Hayaku ika nai?* / *Hayaku ika nai ka?*
 ‘Go quickly!’ / ‘Go quickly?’ / ‘Go quickly?’

Moreover, as observed by Sudo (2013), expletive *nai* in matrix contexts induces doxastic or teleological positive bias toward a proposition with respect to the context uttered.⁹

- (22) A: (Looking at a guidebook) There are all sorts of restaurants around here.
 B: *Dokoka nihon-shoku nai?*
 somewhere Japanese-food NEG
 ‘Isn’t there some Japanese restaurant?’
 ↪ The speaker wants there to be a Japanese food restaurant; or
 ↪ The speaker thinks there would be a Japanese food restaurant.

Given the observations above, I assume that expletive *nai* in the matrix contexts imposes the following conventional effect.^{10, 11}

- (23) The conventional positive bias of *nai*_{EN}(*p*) in matrix environments
 $[DC_{sp} + p] >_{\text{likelihood/desirability}} [DC_{sp} + \neg p]$
 (i.e., updating *DC* with *p* is more likely/desirable than with $\neg p$.)

The assumption above leads to the following analysis of the meaning of sentences with expletive *nai* in directive/suggestive uses. Let me begin with sentences with expletive *nai* in [w/?, w/o *ka*] (e.g., (4a)). Assuming that in Japanese, the directive operator ‘DIR’ can occur in certain non-imperative form sentences if the directive presuppositions are satisfied (Ihara 2021), the sentence in (4a) obtains the following interpretation.

⁸Sudo (2013) refers to such *nai* as “outside”-negation, rather than as expletive negation.

⁹Sudo moreover observes the “evidential” bias of expletive *nai*, which is omitted for the sake of simplicity.

¹⁰We can also incorporate the effect into the Table model as proposed by some authors in the literature by using the *projected* commitment set (Malamud & Stephenson 2015, Jeong 2018).

¹¹What the current discussion indicates is the interesting fact that when expletive *nai* arises in the matrix environment rather than the embedded environment, the bias it conveys flips from negative to positive. Since it is difficult to determine what principles are at work here that are responsible for this phenomenon, giving a unified account for the embedded and matrix EN in Japanese is left as an important issue for the future.

(24) “*Hayaku aruka nai?*” ‘Walk quickly?’ (= (4a))

Simplified structure: $\uparrow?$ [DIR [*nai*_{EN} [*p*: the addressee walks quickly]]]

a. DIR \rightsquigarrow $T_{K'} = T_K + \{p\}$ b. $\uparrow?$ \rightsquigarrow $DC'_{K, tel} = DC_{K, tel}$

c. *nai*_{EN} \rightsquigarrow $[DC_{sp} + p]$ $>_{desirability} [DC_{sp} + \neg p]$

Intuitively, (4a) conveys that (a) $\{p\}$ is the issue to be resolved, (b) the speaker is not teleologically committed to p , and (c) the speaker is teleologically biased toward p . Since the speaker is not committed to p but just biased toward p teleologically, the sentence is relatively weaker than standard directives (just like tag-questions or rising declaratives, cf. Malamud & Stephenson 2015), expressing the suggestive flavor. Note that the bias conveyed by expletive *nai* is crucial to the interpretation in (24); without the bias, (4a) would have the same effect as rising imperatives in English, contrary to the fact that rising imperatives are generally weaker than (4a) in the sense that rising imperatives can be free from the speaker’s preference.

Next consider sentences with *nai* in [w/o?, w/o *ka*] (e.g. (4b)) which only have SN-interpretation. The sentence in (4b) obtains the following interpretation.

(25) “*Hayaku aruka nai!*” ‘Don’t walk quickly!’ (= (4b))

Simplified structure: $\downarrow!$ [DIR [*nai*₋ [*p*: the addressee walks quickly]]]

a. $nai(p) = \neg p$ b. DIR \rightsquigarrow $T_{K'} = T_K + \{\neg p\}$

c. $\downarrow!$ \rightsquigarrow *default update* (i.e., $DC'_{K, tel, sp} = DC_{K, tel, sp} + \neg p$)

As shown in Section 4.2., EN-interpretation is not available in this case, hence $nai(p) = \neg p$. Non-rising intonation “ $\downarrow!$ ” indicates that the update is made default, which leads to the teleological commitment. The entire meaning therefore becomes identical with the ordinary negative directive utterance.

As for the case [w/?, w/*ka*] (e.g., (5a)), the interpretation of the sentence becomes identical with the case [w/?, w/o *ka*] in (4a) (except for the availability of SN-reading because of the occurrence of *ka*, cf. (18), (19a)). Finally, sentences with *nai* in [w/o ?, w/ *ka*] (e.g., (5b)) have the interpretation illustrated in (26).

(26) “*Hayaku aruka nai ka!*” ‘Walk quickly!’ (= (5b))

Simplified structure: $\downarrow!$ [DIR [*ka* [*nai*_{EN} [*p*: the addressee walks quickly]]]]

a. *ka* \rightsquigarrow non-veridicality b. *nai*_{EN} \rightsquigarrow $[DC_{sp} + p]$ $>_{desirability} [DC_{sp} + \neg p]$

c. DIR \rightsquigarrow $T_{K'} = T_K + \{p\}$ d. $\downarrow!$ \rightsquigarrow *default update* (i.e., $DC'_{K, tel, sp} = DC_{K, tel, sp} + p$)

In (26), (a) *ka* as a non-veridicality marker licenses *nai* to be expletive, (b) expletive *nai* vacuously conveys a teleological bias, (c) the directive operator raises $\{p\}$ as an issue, and (d) the update made by the operator is genuine teleological commitment toward p , hence conveying a directive flavor.¹²

¹²One may think that the use of expletive *nai* in (5b) is semantically vacuous because the bias meaning seems not to affect the meaning of the sentence. Here, I assume that an additional “evidential” bias of expletive *nai* (cf. Sudo 2013) comes into play, which makes the use contributive. Although the analysis is left as a future work, there seems to be a crucial difference between (5b) and directives without *nai*. As shown in (i), unless there is circumstantial evidence that the addressee is not performing on the content of the proposition (i.e., the addressee walks quickly), (5b) cannot be used, and indeed it is infelicitous to utter (5b) in out-of-the-blue contexts, (ii).

(i) [Context: the addressee does not start walking even though she is instructed to walk.]

a. *Hayaku aruka nai ka!* ‘Walk quickly!’ (= (5b)) b. *Hayaku aruku!* ‘Walk quickly!’

4.4. Why triviality?

What exactly is the reason why trivial commitments can license expletive *nai*? As I have discussed in the earlier section, expletive *nai* in matrix environments is a subjunctive mood marker that conveys mandatory positive bias toward a proposition p . For instance, in (4a), the speaker utters the sentence expecting that the addressee walks quickly. Crucially, to bring about this bias, the speaker must not be committed to either p or $\neg p$, because if she is committed about either (i.e., if she makes a non-trivial commitment about p), there is no point in bringing about that additional bias. In other words, commitment to p must be avoided when someone makes a bias to the same p . Take (4b), where *nai* cannot be licensed as EN because of the lack of *ka* and rising intonation, for example. Here, the speaker is teleologically committed to p , thus the output context will contain $DC_{sp, tel}$ such that p is added. In this case, the bias imposed by *nai*, namely ‘ $[DC_{sp} + p] >_{desirability} [DC_{sp} + \neg p]$ ’ (i.e., p is more desirable than $\neg p$), cannot affect the meaning of its host sentence, because the bias meaning is semantically weaker than the teleological commitment conveyed by the sentence, namely ‘ $DC_{sp, tel} + p$ ’ (i.e., ‘ p is maximally desirable (and $\neg p$ is undesirable)’). Since expletive *nai* ends up losing its semantic contribution, expletive *nai* is blocked from arising in (4b). To implement this, we can make use of the general principle in Crnič (2011). An occurrence of expletive *nai* in sentences without rising intonation and *ka* will then violate this principle.

(27) *Principle of non-vacuity* (Crnič 2011: 110)

The meaning of a lexical item used in the discourse must affect the meaning of its host sentence (either its truth-conditions or its presuppositions).

If a commitment made by an utterance is trivial, the use of expletive *nai* is motivated. That is, if an utterance does not update a context by adding p to $DC_{sp, tel}$, the bias imposed by expletive *nai* will then affect the meaning of the utterance non-vacuously, which motivates the use of expletive *nai*. This line of analysis is also compatible with Yoon’s (2011; 2013) approach that assumes that the licenser of expletive negation is non-veridicality/uncertainty meaning. The current proposal follows her idea when the associated commitment is doxastic/epistemic one; the use of expletive *nai* is motivated only when the doxastic bias meaning (i.e., $[DC_{sp} + p] >_{likelihood} [DC_{sp} + \neg p]$) conveyed by *nai* contributes to the meaning of the host sentence, i.e., when the commitment conveyed by the sentence is made non-veridical/uncertain.

5. Beyond directives

Before concluding the paper, this section shows some predictions of the present analysis, which cannot be accounted only by the previous account based on non-veridicality. First, as observed among languages (e.g., Italian (Delfitto & Fiorin 2014), German (Roguska 2007, a.o.), Paduan Italian (Zanutini & Portner 2003) and Korean (Yoon 2011)), Japanese also allows exclamatives with expletive *nai*. In (28), *nai* is licensed expletively without *ka* and rising intonation, which will be problematic in the non-veridicality-based account since exclamatives presuppose factivity of p (Abels 2010, a.o.) and moreover no local licenser exists in the sentence.

(ii) [Out-of-the-blue context]

- a. #*Hayaku aruka nai ka!* ‘Walk quickly!’ (= (5b)) b. *Hayaku aruku!* ‘Walk quickly!’

- (28) Are-wa fujisan-ja nai (ka)!
 that-TOP Mt.Fuij-COP.TOP NEG Q
 ‘(Wow,) That’s Mt. Fuji!’

Assuming that exclamatives are speech acts that do not contribute to the regular discourse commitment like assertions or directives, in the sense that exclamatives do not put the uttered proposition to the discourse commitment set directly (cf. Trotzke & Giannakidou 2019, Hirayama 2021), then the discourse move made by exclamatives should always be trivial, thereby licensing expletive *nai* by their own discourse property.¹³

Next, the present analysis predicts that *nai* in information-seeking questions can be expletive whereas in rhetorical questions (RQs) cannot, since while the speaker in the former is not committed to p or $\neg p$, the latter requires the speaker to commit to the truth doxastically, because the commitment in the latter is made non-trivial. This prediction is borne out, as can be seen in (29). In (29), *toiuno* is a marker of RQs (Caponigro & Sprouse 2007, a.o.) and imposes that the speaker is commit to p negatively.

- (29) a. Ame hut-te nai?
 rain fall-PROG NEG
 ‘Isn’t it raining?’ or ‘Is it not raining?’
 b. Ame hut-te nai **toiuno**?
 rain fall-PROG NEG TOIUNO
 ‘[lit.] Is it not raining?’ (#‘Isn’t it raining?’) \rightsquigarrow It is raining.

Crucially, the RQ in (29) is uttered with rising intonation, indicating that rising intonation itself is not a (local or semantic) licenser of EN. Thus, only the global account of EN-licensing based on commitment triviality can capture the contrast in (29).

Finally consider the case of *nai* in assertive utterances that we have observed in Section 2. In (6), where utterances with *ka* are interpreted as assertions, *nai* cannot obtain the expletive interpretation. Both the triviality-based account and the non-veridicality-based account seem to fail to capture this phenomenon, since *nai* should be licensed expletively by *ka* as a non-factive marker. The pivotal fact that we should focus on here is that the sentence is followed by falling intonation rather than rising intonation. According to the literature (e.g., Davis 2011, Yokoyama 2013, Taniguchi 2016) a sentence with *ka* loses its non-factive property when followed by falling intonation. More specifically, when the associated discourse commitment is doxastic one, DC_{dox} , *ka* with falling intonation no longer plays a role of a non-factive marker. Although the implementation would vary depending on the analysis, the explanation here captures the fact in question, which at first glance appeared to be an exception.¹⁴

6. Conclusion

This paper has given an account of why expletive negation in Japanese can be licensed under certain discourse/pragmatic conditions. Focusing on directive speech-acts, I have argued that

¹³This view is motivated by some empirical facts, e.g., exclamatives cannot be used to answer to questions (Rett 2011, a.o.).

¹⁴For instance, Davis (2011) uses the abstract rhetorical morpheme for *ka*, and Taniguchi (2016) proposes that in the current case falling intonation is a reflexivizer that turns an addressee-oriented question into a self-oriented and a self-answered one.

in addition to the non-veridical account, the account based on triviality of the discourse commitment is required.

Further investigation of EN across contexts and languages is of course needed. As reported in Yoon (2011), since EN shows a variety of licensing environments cross-linguistically, the new perspective of EN in this paper, namely the perspective of why and how EN can occur in matrix contexts, will provide a deeper and broader understanding of the typology of EN. (For instance, Paduan Italian and German allow EN in exclamatives but do not in directives (Zanuttini & Portner 2003, Roguska 2007).)

Another important result of this paper is that it supports the view of Yoon (2011; 2013) that EN is not standard negation but is a subspecies of subjunctive mood marker that imposes bias. Departing from Yoon, however, the analysis has suggested that the bias is not constant since the bias employed by EN in Japanese can be both negative (in embedded contexts) and positive (in matrix contexts), which will be a further motivation to push forward the examination of the global account of EN in the future.

References

- Abels, Klaus. 2002. Expletive (?) negation. In *Proceedings of FASL 10*, ed. by Jindra Toman, 1-21. Bloomington, ID: Michigan Slavic Publications.
- Abels, Klaus. 2010. Factivity in exclamatives is a presupposition. In *Studia Linguistica* 64, 141-157. Hoboken: Wiley Blackwell Publishing.
- Caponigro, Ivano and Jon Sprouse. 2019. Rhetorical questions as questions. In *Proceedings of Sinn und Bedeutung* 11, ed. by Estela Puig-Waldmüller, 121-133. Barcelona: Universitat Pompeu Fabra.
- Chatzopoulou, Katerina. 2012. *Negation and nonveridicality in the history of Greek*. Ph.D. thesis, University of Chicago.
- Condoravdi, Cleo and Sven Lauer. 2012. Imperatives: Meaning and illocutionary force. In *Empirical issues in syntax and semantics* 9, ed. by Christopher Piñón, 37-58. Bern: Peter Lang Publishing.
- Crnič, Luka. 2011. *Getting even*. PhD dissertation. Cambridge, MA: MIT.
- Davis, Christopher. 2011. *Constraining interpretation: Sentence final particles in Japanese*. Ph.D. Dissertation, UMass Amherst.
- Delfitto, Denis and Gaetano Fiorin. 2014. Negation in exclamatives. In *Studia Linguistica* 68, 284-327. Hoboken: Wiley Blackwell Publishing.
- Delfitto, Denis, Chiara Melloni, and Maria Vender. 2019. The (en)rich(ed) meaning of expletive negation. In *Evolutionary Linguistic Theory* 1, 57-89. Amsterdam: John Benjamins.
- Espinal, Maria Teresa. 2007. Licensing expletive negation and negative concord in Catalan and Spanish. In *La négation dans les langues romanes*, ed. by Franck Floricic, 47-74. Amsterdam: John Benjamins.
- Farkas, Donka and Kim Bruce. 2010. On reacting to assertions and polar questions. In *Journal of semantics* 27, 81-118. Oxford: Oxford University Press.
- Giannakidou, Anastasia. 2009. The dependency of the subjunctive revisited: temporal semantics and polarity. In *Lingua* 120. 1883-1908. North Holland: Elsevier.
- Hirayama, Hitomi. 2021. Exclamations and their discourse effects in Japanese. In *Proceedings of the Linguistic Society of America*, Vol. 6, ed. by Patrick Farrell, 411-420. Linguistic Society of America.
- Ihara, Shun. 2021. Division of labor between semantics and pragmatics of canonical and non-canonical imperatives. In *Gengo Kenkyu: Journal of the Linguistic Society of Japan* 160, 155-182. Linguistic Society of Japan.
- Jeong, Sunwoo. 2018. Intonation and sentence type conventions: Two types of rising declaratives. In *Journal of Semantics* 35, 305-356. Oxford: Oxford University Press.
- Kaufmann, Magdalena. 2012. *Interpreting imperatives*. New York: Springer.
- Malamud, Sophia and Tamina Stephenson. 2015. Three ways to avoid commitments: Declarative force modifiers in the conversational scoreboard. In *Journal of Semantics* 32, 275-311. Oxford: Oxford University Press.
- Mari, Alda and Chloé Tahar. 2020. Negative priorities: Evidence from prohibitive and expletive negation. In *Proceedings of Sinn und Bedeutung* 24, Vol. 2, ed. by Michael Franke, Nikola Kompa, Mingya Liu, Jutta L. Mueller, and Juliane Schwab, 56-71. Osnabrück University.
- Mizuno, Teruyuki. 2021. Q-particles in embedded declaratives, mood, and clausal complementation. In *Proceedings of SALT* 31, ed. by Nicole Dreier, Chloe Kwon, Thomas

- Darnell, and John Starr, 405-425. Linguistic Society of America.
- Rett, Jessica. 2011. Exclamatives, degrees and speech acts. In *Linguistics and Philosophy* 34, 411-442. New York: Springer.
- Roguska, Magdalena. 2007. *Exklamation und negation*. Doctoral Dissertation, Universität Mainz.
- Rudin, Deniz. 2018. Rising imperatives. In *Proceedings of SALT 28*, ed. by Sireemas Maspong, Brynhildur Stefánsdóttir, Katherine Blake and Forrest Davis, 100-119. Linguistic Society of America.
- Sailer, Manfred. 2021. Minimizer negative polarity items in non-negative contexts. In *Proceedings of the 28th International Conference on HPSG*, ed. by Stefan Müller and Nurit Melnik, 348-368. Frankfurt: the University Library of Goethe-Universität.
- Sedivy, Julie. 1990. Against a unified analysis of negative polarity licensing. In *Cahiers Linguistiques D'Ottawa* 18, 95-105. Ottawa: Presses de l'Université d'Ottawa.
- Sudo, Yasutada. 2013. Biased polar questions in English and Japanese. In *Beyond expressives: Explorations in use-conditional meaning*, ed. by Daniel Gutzmann and Hans-Martin Gärtner, 275-296. Leiden: Brill.
- Taniguchi, Ai. 2016. Sentence-final *-ka-yo* in Japanese: A compositional account. In *Proceedings of FAJL 8*, ed. by Ayaka Sugawara, Shintaro Hayashi, and Satoshi Ito, 165-176. Cambridge, MA: MITWPL.
- Trotzke, Andreas and Anastasia Giannakidou. 2019. Exclamatives as emotive assertions of intensity. ms., University of Konstanz and University of Chicago.
- Truckenbrodt, Hubert. 2006. On the semantic motivation of syntactic verb movement to C in German. In *Theoretical Linguistics* 32, ed. by Hans-Martin Gärtner, 257-306. Berlin: Mouton de Gruyter.
- van der Wurff, Wim. 1998. On expletive negation with adversative predicates in the history of English. In *Negation in the history of English*, ed. by Ingrid Tieken-Boon van Ostade, Gunnel Tottie and Wim van der, 295-327. Berlin: Mouton de Gruyter.
- Yokoyama, Tomohiro. 2013. Re-evaluating the “question” marker *ka* in Japanese. In *Canadian Linguistic Association Annual Conference Proceedings 2013*.
- Yoon, Suwon. 2011. *Not in the mood: The syntax, semantics and pragmatics of evaluative negation*. Ph. D. thesis, University of Chicago.
- Yoon, Suwon. 2013. Parametric variation in subordinate evaluative negation: Korean/Japanese versus others. In *Journal of East Asian Linguistics* 22, ed. by C.T. James Huang, 133-166. New York: Springer.
- Zeijlstra, Hedde. 2004. Sentential negation and negative concord. Ph.D. thesis, University of Amsterdam.
- Zanuttini, Raffaella and Paul Portner. 2003. Exclamative clauses: At the syntax-semantics interface. In *Language* 79, 39-81. Linguistic Society of America.

Aspect in Hindi-Urdu and transition between syntactic domains*

Gurmeet Kaur, Julie Goncharov

University of Göttingen

1. Introduction

In this paper, we present a unified account of two properties of affixal aspect (perfective/habitual) in Hindi-Urdu/HU: (i) truncation, i.e. the ability of a verb with affixal aspect to stand alone without a tensed auxiliary, and (ii) the ban on affixal aspect in imperatives and simple future clauses.

Generally, a (present/past) tensed clause in HU contains a verb which hosts affixal aspect and a be-auxiliary, which hosts tense morphology, as in (1). However, a clause with a verb that hosts aspectual affixes can occur without the tensed auxiliary, as shown in (2). In this case, we say that the clause is truncated and label this property as truncation.

(1) karan kayiiN baar dilli jaa-taa hai
 Karan many times Delhi go-HAB.M.SG be.PRS.3SG
 ‘Karan goes to Delhi many times.’

(2) karan kayiiN baar dilli jaa-taa
 Karan many times Delhi go-HAB.M.SG
 ‘Karan would go to Delhi many times.’

The second property pertains to the distribution of affixal aspect. While affixal aspect is obligatorily required in tensed clauses; see (3), it cannot occur in imperatives and simple future clauses, as shown in examples (4)-(5).

(3) karan dilli jaa-*(taa) hai
 Karan Delhi go-HAB.M.SG be.PRS.3SG
 ‘Karan goes to Delhi.’

(4) dilli jaa-*(taa)-o
 Delhi go-HAB-IMP.2N¹
 ‘Go to Delhi!’

(5) karan dilli jaa-*(taa)-e-gaa
 Karan Delhi go.HAB-SBJV.3SG-FUT.M.SG
 ‘Karan will go to Delhi.’

* This paper has benefited from discussions with Rajesh Bhatt, Hedde Zeijlstra and Neil Banerjee at different stages of this project. We would also like to thank our audience at the Oberseminar English Linguistics, University of Goettingen (June 2022) and at Glow in Asia XIII (August 2022) for their feedback. All errors are our own.

¹ 2N refers to 2nd person neutral, which is distinct from the 2nd person intimate (2INT) and 2nd person honorific (2H) forms.

Assuming a tri-partition of the clause into a V-domain that corresponds to events, a T-domain that corresponds to situations, and a C-domain that corresponds to propositions (e.g. Ramchand & Svenonius 2014), we claim that affixal aspect in HU encodes a transition from an event description to a situation description with an added requirement that the created situation is unique. Our proposal captures truncation as a definite description of a situation. Adding the assumption that future is non-deterministic helps explain the ban on affixal aspect in imperatives and future clauses and the lack of future-readings with truncation.

The paper is organized as follows: in Section 2, we present the two properties of affixal aspect in detail. Section 3 provides our main proposal. In Section 4, we discuss two apparent counterexamples to our proposal. Section 5 concludes the paper.

2. Two properties of affixal aspect in HU

2.1 Property I: Truncation

HU has three grammatical aspect markers of which two are affixal and one is non-affixal: (a) Perfective: affixal (*-aa/-yaa*), (b) Habitual: affixal (*-taa*), and (c) Progressive: stand-alone auxiliary (*rah*). In this paper, we focus on the affixal (perfective and habitual) aspectual morphology since only affixal aspect shows both properties under discussion. In a tensed clause in HU, which can be present or past, affixal aspect (habitual/perfective) is hosted on the verb. As shown in (6), the verb ‘go’ can bear the habitual or perfective affixes. Tense (here, present) is realized on a be-auxiliary.

- (6) a. karan kayiiN baar dilli jaa-taa hai
 Karan many times Delhi go-HAB.M.SG be.PRS.3SG
 ‘Karan goes to Delhi many times.’
 b. karan kayiiN baar dilli ga-yaa hai
 Karan many times Delhi go-PFV.M.SG be.PRS.3SG
 ‘Karan has been to Delhi many times.’

In such tensed clauses, the locus of affixes is fixed - aspectual morphology appears on the verb and tense morphology on the be-auxiliary. For instance, the verb cannot host tense morphology, and the be-auxiliary cannot host aspectual affixes.

- (7) *karan kayiiN baar dilli jaa-taa-ai ho
 Karan many times Delhi go-HAB-PRS be
 Intended: ‘Karan goes to Delhi many times.’
 (8) *karan kayiiN baar Delhi jaa ho-taa-ai
 Karan many times Delhi go be-HAB-PRS
 Intended: ‘Karan goes to Delhi many times.’

Furthermore, what is crucial is that it is obligatory for the verb to occur with aspectual morphology - omission of aspect marking leads to ungrammaticality, as in (9).

- (9) karan kayiiN baar dilli jaa-*(taa) hai
 Karan many times Delhi go-HAB.M.SG be.PRS.3SG
 ‘Karan goes to Delhi many times.’

However, the be-auxiliary hosting tense morphology can be omitted. In other words, clauses where the verb bears affixal (perfective or habitual) aspect in HU can be truncated after the aspect-hosting verb, while still yielding a proposition (Bhatt 1997, Davison 2002, Bhatt & Keine 2017 among others). In (10), we see instances of truncated habitual clauses. The habitual verb can occur without a tensed auxiliary when the sentence contains an adverb of quantification, as in (10a). Similarly, a truncated habitual can also occur in a when-clause, as in (10b) (see Bhatt 1997 for more discussion). A tensed clause with a perfective verb can also be truncated – we show a present perfective tensed clause in (11a) and its truncated counterpart in (11b).

- (10)a. karan kayiiN baar dilli jaa-taa
 Karan many times Delhi go-HAB.M.SG
 ‘Karan would go to Delhi many times.’
- b. jab mira dilli jaa-tii, tab karan bhii
 when Mira.NOM Delhi go-HAB.F.SG then Karan.NOM also
 jaa-taa
 go-HAB.M.SG
 ‘When Mira would go to Delhi, Karan would too.’
- (11)a. karan dilli ga-yaa hai
 Karan Delhi go-PFV.M.SG be.PRS.3SG
 ‘Karan has gone to Delhi.’
- b. karan dilli ga-yaa
 Karan Delhi go-PFV.M.SG
 ‘Karan went to Delhi.’²

There are two characteristics of truncation that are relevant for us: first, truncation can only take place after the verb that hosts affixal aspect. HU is well-known to have compound verbs (CVs), a productive class of verbal structures that consist of a main verb (MV) and a light verb (LV) (see Hook 1973, Butt 2003). The light verb is semantically bleached - it contributes meanings such as inception, completion, benefaction, suddenness, among many others. Consider the following examples. In (12), the verb ‘go’ is used as the main verb. Contrast this with its use as a light verb in (13) – here, it does not contribute to the main action, which is contributed by the main verb ‘come’ instead.

- (12)karan kayiiN baar dilli jaa-taa hai
 Karan many times Delhi go-HAB.M.SG be.PRS.3SG
 ‘Karan goes to Delhi many times.’
- (13)karan kayiiN baar dilli aa jaa-taa hai
 Karan many times Delhi come go-HAB.M.SG be.PRS.3SG
 ‘Karan comes to Delhi many times.’

² We employ the simple past in English to translate truncated perfective clauses in HU, in keeping with standard practice among HU linguists (e.g. Bhatt 1997, Davison 2002). However, we are not committed to a uniform grammatical treatment of the truncated perfective in HU and the simple past in English at this stage.

As shown in (13), in the presence of a light verb, it is this light verb (and not the main verb) that hosts aspectual marking in a tensed clause. Tense, per usual, obtains on the be-auxiliary. Crucially, this clause with a compound verb can only be truncated after the aspect-hosting LV, and not after the uninflected MV, (14).

- (14) karan kayiiN baar dilli aa jaa-taa /*aa
 Karan many times Delhi come go-HAB.M.SG/ come
 ‘Karan would come to Delhi many times.’

Thus, as (14) clearly demonstrates, truncation cannot take place lower than the structural position that hosts affixal aspect.

The second property of truncation corresponds to its temporal interpretation. Not surprisingly, tensed clauses with an overt auxiliary are interpreted as present or past. Truncated clauses lack a be-auxiliary. Regardless, they can only be used to describe a past or present action but not a future action. Consider the truncated habitual in (15a) which is used to describe a past habitual event, as evidenced by the felicitous occurrence of only a past adverbial such as ‘last year’. A truncated habitual clause can also describe a present habitual event, but only in the presence of negation, as in (15b). A truncated perfective clause can have both past and present interpretations, regardless of negation. This is shown in (16), which is compatible with both present and past adverbials.

- (15)a. pichhle saal/#aaj-kal karan har hafte dilli jaa-taa
 last year/nowadays Karan every week delhi go-HAB.M.SG
 ‘Last year/#nowadays, Karan would go to Delhi every week.’
 b. aaj-kal/#pichhle saal karan har hafte dilli nahiiN jaa-taa
 nowadays/last year Karan every week Delhi NEG go-HAB.M.SG
 ‘Nowadays/#last year, Karan does not go to Delhi every week.’
- (16) karan-ne picchle hafte/aaj ek kitaab paRh-ii
 Karan- ERG last week/today one book read- PFV.M.SG
 ‘Karan read a book last week/today.’

Despite the lack of a tensed be-auxiliary, truncated clauses cannot be used to describe a future event. This is shown for a truncated habitual, both with and without negation in (17a) and (17b) – a future adverbial is infelicitous in both sentences. Same facts obtain for a truncated clause with a perfective verb, (18). Note the use of *kal*, which can normally mean either ‘yesterday’ or ‘tomorrow’. In (18), *kal* cannot mean ‘tomorrow’.

- (17) a. #agle saal karan har hafte dilli jaa-taa
 next year Karan every week Delhi go-HAB.M.SG
 Intended: ‘Next year, Karan will go to Delhi every week.’
 b. #agle saal karan har hafte dilli nahiiN jaa-taa
 next year Karan every week Delhi NEG go-HAB.M.SG
 Intended: ‘Next year, Karan will not go to Delhi every week.’
- (18) karan-ne kal ek kitaab paRh-ii
 Karan- ERG yesterday/#tomorrow one book read- PFV.M.SG
 ‘Karan read a book yesterday/#tomorrow.’

In summary, in HU, a verb with affixal aspect can stand alone without a tensed auxiliary. This stand-alone clause must contain affixal aspect, i.e. it cannot be truncated lower. Moreover, despite the lack of a tensed be-auxiliary, truncated clauses can only be interpreted as past or present but never future.

2.2 Property II: Ban in imperatives and simple future clauses

2.2.1 General description of the ban

As already seen, aspectual morphology is obligatory on the verb in tensed (and truncated) clauses. However, imperatives and simple future clauses can never host affixal aspectual morphology. The verb in an imperative must host imperative morphology. Consider (19), where the verb bears the imperative morphology for an honorifically neutral addressee, realized as *-o*. Aspectual morphology is banned on the verb.

(19) dilli jaa-(*taa)-o
 Delhi go-HAB-IMP.2N
 ‘Go to Delhi!’

The same pattern is attested in simple future clauses. Future in HU is marked via subjunctive morphology (*-e/∅*) plus *-gaa*, which has originated from the verb ‘go’, (20). Again, no aspectual morphology is allowed on the verb.

(20) karan dilli jaa-(*taa)-e-gaa
 Karan Delhi go.HAB-SBJV.3SG-FUT.M.SG
 ‘Karan will go to Delhi.’

CVs can also occur in imperatives and future clauses as shown in (21) and (22) respectively. Despite the availability of two verbs, affixal aspect cannot occur in imperatives and simple future clauses with a CV. As shown in (21) and (22), the main verb ‘come’ must remain bare and the light verb ‘go’ must host imperative/future morphology alone.

(21) dilli aa jaa-(*taa)-o
 Delhi come go-HAB-IMP.2N
 ‘Come to Delhi!’

(22) karan dilli aa jaa-(*taa)-e-gaa
 Karan Delhi come go.HAB-SBJV.3SG-FUT.M.SG
 ‘Karan will come to Delhi.’

It is important to note that this ban is neither due to the morpho-phonology of the verb nor due to the lexical meaning of an individual aspectual marker. We discuss both these possibilities below and show that accounts based on either of these options are empirically inadequate.

2.2.2 Against a purely morpho-phonological explanation

According to a possible morpho-phonological account, there is a restriction on how much inflectional material can combine with a verb in HU. An aspectual affix on the future/imperative verb form exceeds the designated limit of affixes on the verb, leading to the

ban.

Typically, HU allows one affix per verb (e.g. *jaa-naa* ‘go-inf’). However, we also have the future form, which contains two affixes (*jaa-e-gaa* ‘go-sbjv-fut’). Based on whether we take the maximum number of affixes per verb stem as one or two, we have two lines of argumentation, both of which fail to explain the ban. We first take the future verb as our template and assume that HU verb can allow up to two affixes. Aspectual marking is correctly ruled out in the future since it adds an extra affix (**jaa-taa-e-gaa* ‘go-hab-sbjv-fut’). However, since imperative morphology uses a single affix, and HU verb can allow up to two affixes, imperatives should allow aspectual affixes. This is not borne out (**jaa-taa-o* ‘go-hab-imp.2n’).

Alternatively, we assume that HU allows only one affix per verb stem and the future morphology is special in that it is grammaticalized as one affix. Under this one affix per verb limit, the ban on aspectual affixes in both future and the imperative for a honorifically neutral addressee is explained since aspect adds an affix to the verb which already has an affix, crossing the designated limit: (**jaa-taa-egaa* ‘go-hab-fut’) and (**jaa-taa-o* ‘go-hab-imp.2n’). However, consider the immediate imperative for an informal/intimate addressee in (23). The imperative ending in (23) is null, which should allow the realization of affixal aspect. This is not borne out.

- (23) dilli jaa-(*taa)-Ø
 Delhi go-HAB-IMP.2INT
 ‘Go to Delhi!’

Thus, the ban on affixal aspect in imperatives and simple future clauses remains unexplained under a purely morpho-phonological approach.

2.2.3 Against a lexical meaning based explanation

Van der Auwera et al. (2009) propose that the meaning (semantics/pragmatics) of individual aspect markers can be a relevant factor determining their incompatibility in imperatives in some languages. For instance, it is well-known that the progressive form of the verb is very rare, if not completely unavailable, in English imperatives.

- (24) * Be eating food!

This restriction on the marker (*be V-ing*) can be made to obtain from its meaning. Taking aspectual morphology to describe the relationship between the salient ‘time under discussion’ (Topic Time), and the ‘time of predication’ (Event Time), the progressive marker indicates that TT is contained within the ET, and not the other way around. Since imperatives typically involve an appeal to the hearer to perform the action as a whole and not merely to be engaged in the activity or part of it, the progressive is generally not allowed in imperatives.

There are at least two issues with extending this approach to the ban on affixal aspect in imperatives and simple future clauses in HU. First, this approach is better-suited to linguistic systems that, in general, allow aspectual morphology in imperatives, but may ban a certain aspectual marker due to its meaning. HU, however, bans all aspectual morphology in imperatives. We have already seen the ban on habitual marker in imperatives, as in (19). This ban extends to the perfective marker, as shown in (25).

- (25) dilli jaa-(*yaa)-o
 Delhi go-PFV-IMP.2N
 ‘Go to Delhi!’

Secondly, the empirical domain of this approach is restricted to imperatives and does not necessarily generalize to other types of sentences. For instance, while the distribution of the progressive is restricted in English imperatives, it occurs freely in the future, (26). However, the ban on aspectual morphology on the verb in HU extends across imperatives and future clauses.

- (26) John will be eating food later.

Thus, given the ban on all aspectual morphology across not only imperatives but also future clauses in HU, this approach based on the semantic/pragmatic incompatibility of individual aspect markers and imperatives does not suffice for the language.

In summary, affixal aspect in HU shows two properties: (i) a clause in HU can be truncated after the aspect-hosting verb, and (ii) affixal aspect in HU cannot occur in imperatives and simple future clauses - this ban is neither due to morpho-phonology nor due to the meaning of individual aspect markers.

3. Proposal

3.1 Generalization

Given the two properties as discussed in the last section, a clear generalization emerges: affixal aspect in HU is incompatible with a future reading.

See Table 1 - tensed clauses have both aspectual morphology and a be-auxiliary, and cannot be future-oriented. Imperatives and future clauses lack both aspectual morphology and a be-auxiliary, and are future-oriented. Despite lacking a be-auxiliary, truncated clauses pattern with tensed clauses, and cannot be future-oriented.

| | | V-asp | be-tense | Future | Non-future |
|---|-----------------------|-------|----------|--------|------------|
| 1 | Tensed clauses | ✓ | ✓ | × | ✓ |
| 2 | Imperatives | × | × | ✓ | × |
| 3 | Simple future clauses | × | × | ✓ | × |
| 4 | Truncated clauses | ✓ | × | × | ✓ |

Table 1: Form and temporal readings across distinct sentence types

Since both tensed and truncated clauses host aspect, while both imperatives and future clauses lack aspect, we claim that it is affixal aspect in HU, which is incompatible with future readings. This generalization allows us to derive (i) the ban on affixal aspect in imperatives and simple future clauses, both of which are future-oriented structures, and (ii) the lack of future readings with truncated structures (once we explain why truncation can only take place at the projection that hosts affixal aspect).

3.2 Preliminaries: event descriptions, situation descriptions, propositions

To derive the incompatibility of affixal aspect with future in HU, we assume a system similar

to that in Ramchand and Svenonius (2014). Following Hinzen (2006), Ramchand & Svenonius (2014) say that the role of syntax is to build complex semantic meanings that represent basic (interpretable) concepts. We will be interested in three such concepts: events, situations, and propositions.

Events are represented by atemporal event descriptions which include information about relations between sub-events (causation, resultativity), thematic role manipulations (passives, applicatives), and aktionsart specifications (static, dynamic). Event descriptions correspond to syntactic objects in the VP-zone.

$$(27) \quad [[\text{VP...verb...}]] = \lambda e. \text{Verb}(e) \wedge \dots$$

Situations are partial descriptions of the state of affairs (e.g., Barwise and Perry 1983). They are represented by situation descriptions which are elaborations of event descriptions in the sense that they presuppose the existence of eventuality (technically, the eventuality is \exists -closed in a situation description). Unlike events, situations have a time and a world parameter. Thus, a situation is the smallest object that can, in principle, be related to the utterance. Situation descriptions correspond to syntactic objects in the TP-zone which in English hosts auxiliaries and root modals.

$$(28) \quad [[\text{TP...aux...}]] = \lambda_{s_{t,w}}. \text{Aux}(s_{t,w}) \wedge \dots$$

In this system, the transition from event descriptions to situation descriptions is achieved by Asp^* (heads marked with an asterisk are transition heads). Everything below Asp^* is an event description of different complexity, i.e., $\lambda e.P(e)$. Asp^* takes an event description as its complement and builds a situation description which encloses that event description and also provides a time and a world parameter. We can think of the situation built by Asp^* as a reference situation (on a par with Reichenbach's 'point of reference').

$$(29) \quad \text{Asp}^* \rightsquigarrow \lambda Q \lambda_{s_{t,w}} \exists e [Q(e) \wedge \text{Asp}(s_{t,w}, e)]$$

Asp has a particular meaning depending on the meaning of the aspectual morpheme that is used for transition. Asp can also bring additional requirements on the situation. For instance, for Ramchand & Svenonius (2014), English perfect is realis, so it brings in an additional requirement that the world parameter of the reference situation is set to the actual world w^c .

Propositions are enriched situations that include a relationship to the utterance situation s^c , which, in turn, establishes relations to contextual information (including speaker, hearer, time of utterance, etc.). Propositions presuppose a situation (technically, via existential closure). The transition from situations to propositions is made possible by Fin^* , which, in English, can host information about tense (anchoring the t-parameter of the embedded situation) or epistemic/evidential modality by the realis/irrealis distinction (anchoring the w-parameter), which is reminiscent of Iatridou (2000).

$$(30) \quad \text{Fin}^*_{\text{pres}} \rightsquigarrow \lambda R \lambda p [p = \text{Assert}(\exists s [R(s) \wedge s_t = s^c_t])]]$$

$$(31) \quad \text{Fin}^*_{\text{irrealis}} \rightsquigarrow \lambda R \lambda p [p = \text{Assert}(\exists s [R(s) \wedge s_w \neq s^c_w])]]$$

A simple abstract structure will look as in (32). In this structure, we see that different semantic objects correspond to different syntactic projections. Going bottom up, we see that a VP corresponding to an event description combines with Asp*. Asp* creates a situation description which encloses the event description. Thus, Asp*P corresponds to a new semantic object - a situation description. The material at the level of TP enriches the situation description. Then, TP combines with Fin*, which creates a proposition out of the situation description. Thus, Fin*P corresponds to a new semantic object – a proposition. (It should be noted here that propositions in Ramchand & Svenonious (2014) are not classical sets of possible worlds, see Ramchand (2018) for more details. This deviation will not affect our proposal.)

(32)

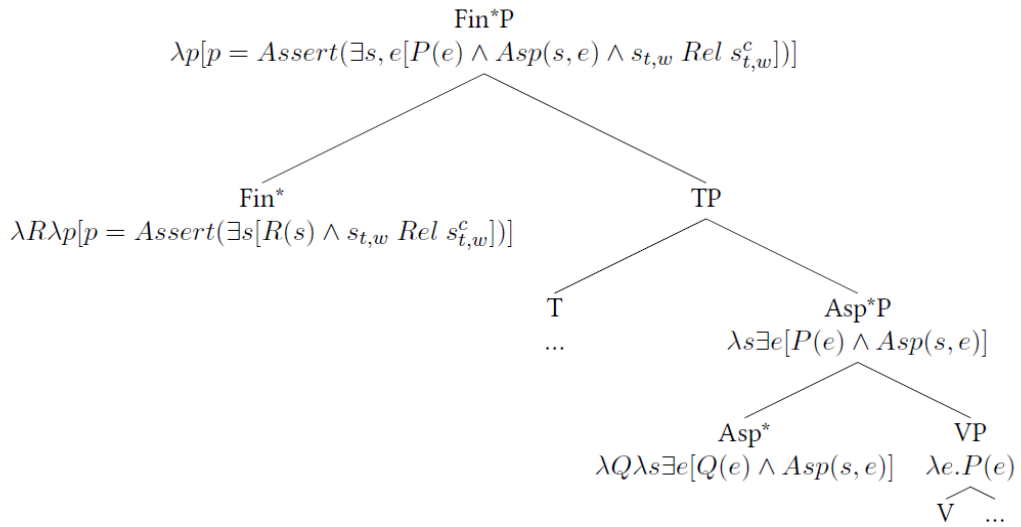

3.3 Aspect in HU

Building on the idea of transition heads, we propose that affixal aspect in HU spells out Asp*. That is to say, in addition to their aspectual meanings, affixal aspect in HU performs the transition from event descriptions to situation descriptions. We also propose that in addition to the transition, Asp* in HU encodes a uniqueness presupposition - it is defined only if the situation it creates is a unique situation, see (33). Here and below, we use Asp*_{hu} as shorthand for Pfv*_{hu} and Hab*_{hu}. Asp, as before, provides a specific aspectual meaning for perfective or habitual in HU.

(33) Asp*_{hu} \rightsquigarrow $\lambda Q\lambda s_{t,w}\exists e [Q(e) \wedge \text{Asp}(s_{t,w}, e)]$
 undefined unless s is a unique situation

With these preliminaries in place, we are ready to derive truncation and the ban on affixal aspect in future-oriented structures in HU. Let us begin with truncation. Our proposal here is that the status of Asp*_{hu} as a transition head and the uniqueness presupposition derive truncation as a definite description of a situation. Being a transition head is a necessary condition for affixal aspect in HU to participate in truncation since situation descriptions introduce t- and w-parameters and thus, are the smallest object that can be related to contextual information. The uniqueness requirement on Asp*_{hu} is another necessary condition for truncation. Let us suppose that \exists -closure is a mechanism that is always available as a last resort. By \exists -closing a situation description with the uniqueness presupposition, we get a definite

description of the situation. It is plausible to propose that like definite descriptions of individuals can refer, definite descriptions of situations can have their truth determined contextually.

$$(34) \quad \exists!s\exists e [Q(e) \wedge \text{Asp}(s, e)]$$

We propose that the above mechanism is what is behind ‘truncation’ and it is made possible in HU by two factors: (i) affixal aspect in HU encodes the transition from events to situations, and (ii) there is a uniqueness requirement on the created situation. At this point we remain agnostic whether proposition formation is indeed necessary (as for Ramchand & Svenonius 2014), how propositions are formed in case of truncation if they are needed, where the assertive illocutionary force comes from, and many other important questions.

Let us now turn to explaining the ban on aspectual affixes in imperatives and simple future clauses. To explain the ban, we need to make one more assumption. We need to assume that future is non-deterministic. The idea that future is non-deterministic is well studied in tense logic since Prior’s and Thomason’s works in late 60s and 70s. The idea is based on the intuition that we need to allow for choices among possible futures. This is captured by assuming that time is linearly ordered only with respect to the present and the past. With respect to the future, time ‘grows’ into a treelike structure, as in (35).

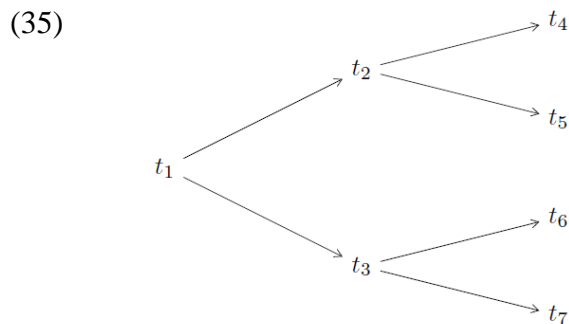

Now, we argue that the uniqueness requirement on Asp^*_{hu} is what is responsible for the ban on affixal aspectual morphology in constructions that describe future-oriented eventualities. To see this, let us begin with noticing that a reference situation s can stand in (at least) six relations to the utterance situation s^c , as shown in Table 2. These six relations correspond to different settings of the t - and w -parameters. In Rel_1 , Rel_2 , and Rel_3 , the world index of the reference situation s is the same as the world index of the utterance situation s^c . So, we say that the world parameter is not shifted here. The time index in Rel_1 is also not shifted, in the sense that the time of the reference situation s overlaps with the time of the utterance situation s^c . The time index in Rel_2 and Rel_3 is backward-shifted and forward-shifted respectively. Rel_4 , Rel_5 , Rel_6 differ from Rel_1 , Rel_2 , Rel_3 in having the world index of the reference situation s correspond to any (relevant) world index, which is not necessarily (but not excluding) the world index of the utterance situation s^c . In this case, we say that the world parameter is shifted (which should be read as ‘possibly shifted’ or ‘shiftable’ as these relations do not necessarily require the reference situation s to be incompatible with the utterance situation s^c).

| | w | t | | |
|------------------|-------------|------------------|-------------|---------------------|
| Rel ₁ | non-shifted | overlap | one-to-one | Present, actual |
| Rel ₂ | non-shifted | backward-shifted | one-to-one | Past, actual |
| Rel ₃ | non-shifted | forward-shifted | one-to-many | Future, actual |
| Rel ₄ | shifted | overlap | one-to-one | Present, non-actual |
| Rel ₅ | shifted | backward-shifted | one-to-one | Past, non-actual |
| Rel ₆ | shifted | forward-shifted | one-to-many | Future, non-actual |

Table 2: Possible Rel(s, s^c)

Given our assumption about how time is structured, only four out of six relations in Table 2 are one-to-one relations with respect to the time-parameter, and thus can satisfy the uniqueness presupposition of Asp*_{hu}. These four relations are encoded by (i) present in the actual world (Rel₁), (ii) past in the actual world (Rel₂), (iii) present epistemic *gaa*-constructions (Rel₄), and (iv) past epistemic *gaa*-constructions (Rel₅), see (36) - (39). Affixal aspectual morphology is acceptable in all (i) - (iv), as shown for habitual aspect in (40).

(36) $\text{Pres}_{\text{hu}} \rightsquigarrow \lambda Q \lambda p [p = \text{Assert}(\exists s [Q(s) \wedge \text{Rel}_1(s, s^c)])]$
 where $\text{Rel}_1(s, s^c) = 1$ iff t of s overlaps with t of s^c \wedge w of s = w of s^c

(37) $\text{Past}_{\text{hu}} \rightsquigarrow \lambda Q \lambda p [p = \text{Assert}(\exists s [Q(s) \wedge \text{Rel}_2(s, s^c)])]$
 where $\text{Rel}_2(s, s^c) = 1$ iff t of s precedes t of s^c \wedge w of s = w of s^c

(38) $\text{Epist}_{\text{hu}} \rightsquigarrow \lambda Q \lambda p [p = \text{Assert}(\forall s [\text{Acc}(s, s^c) \rightarrow Q(s) \wedge \text{Rel}_4(s, s^c)])]$
 where $\text{Rel}_4(s, s^c) = 1$ iff t of s is a counterpart of *now*^c and w of s is shifted wrt w of s^c

(39) $\text{Epist}_{\text{hu}} \rightsquigarrow \lambda Q \lambda p [p = \text{Assert}(\forall s [\text{Acc}(s, s^c) \rightarrow Q(s) \wedge \text{Rel}_5(s, s^c)])]$
 where $\text{Rel}_5(s, s^c) = 1$ iff t of s is a counterpart of *past*^c and w of s is shifted wrt w of s^c

- (40)a. aaj-kal karan roz kasrat kar-taa hai
 nowadays Karan daily exercise do-HAB.M.SG be.PRS.3SG
 ‘Karan exercises daily these days.’
- b. pichhle saal karan roz kasrat kar-taa thaa
 last year Karan daily exercise do- HAB.M.SG be.PST.M.SG
 ‘Karan exercised daily last year.’
- c. aaj-kal/ pichhle saal karan roz kasrat kar-taa
 nowadays/last year Karan daily exercise do- HAB.M.SG
 ho-Ø-gaa
 be-SBJV.3SG-MOD.M.SG³
 ‘Karan must (epistemic) exercise daily nowadays/ last year.’

With the future-*gaa* (whether we analyze it as modal or not), affixal aspectual morphology is

³ HU employs the same *-gaa* morphology in both simple future and epistemic sentences. For ease of exposition, we gloss the *-gaa* in simple future sentences as FUT and the *-gaa* in epistemic constructions as MOD.

unacceptable because the uniqueness presupposition of Asp^*_{hu} cannot be satisfied. (41) and (42) spell out how non-modal (Fut^1) and modal (Fut^2) simple future can be represented in our system.

$$(41) \quad \text{Fut}^1_{\text{hu}} \rightsquigarrow \lambda Q \lambda p [p = \text{Assert}(\exists s[Q(s) \wedge \text{Rel}_3(s, s^c)])]$$

where $\text{Rel}_3(s, s^c) = 1$ iff t of s succeeds t of $s^c \wedge w$ of $s = w$ of s^c

$$(42) \quad \text{Fut}^2_{\text{hu}} \rightsquigarrow \lambda Q \lambda p [p = \text{Assert}(\forall s[\text{Acc}(s, s^c) \rightarrow Q(s) \wedge \text{Rel}_6(s, s^c)])]$$

where $\text{Rel}_6(s, s^c) = 1$ iff t of s is a counterpart of *future*^c and w of s is shifted wrt w of s^c

Similarly, for imperatives treated as future-oriented structures, aspectual morphology is out for the same reason. To make a parallel case for imperatives, let us say that the imperative expresses an order to the addressee to bring about the situation developed from the event description in the complement of the imperative operator. This meaning is not fully satisfactory, but it captures the important (for us) characteristic of imperatives, namely, that they are future-oriented, see (43).

$$(43) \quad \text{Imp}_{\text{hu}} \rightsquigarrow \lambda Q \lambda p [p = \text{Bring} - \text{about}(\exists s[Q(s) \wedge \text{Rel}_3(s, s^c)])]$$

where $\text{Rel}_3(s, s^c) = 1$ iff t of s succeeds t of $s^c \wedge w$ of $s = w$ of s^c

Our system says that affixal aspectual morphology is unavailable with imperatives for the same reason it is unavailable with simple future, namely because the future situation is never unique, and hence the uniqueness presupposition on Asp^*_{hu} can be never satisfied.

3.4 Shifting

We propose that propositions about future and imperatives are constructed by combining the event description with a shifting operator, standardly taken to be a last-resort solution, see (44). Two things are worth mentioning about (44). First, Sh performs the transition from event descriptions to situation descriptions like Asp^*_{hu} but unlike Asp^*_{hu} it does not have a uniqueness presupposition which permits Sh to be used in future constructions and imperatives. Second, the Asp^- relation between the event and the situation that encloses it is (most probably) bleached as compared to the perfective and habitual morphology (which we indicate by the superscript $-$). However, the exact contribution of Asp^- is something that should be further looked at.

(44) Shifting

$$\text{For any event description } Q, \text{Sh}(Q) = \lambda s \exists e [Q(e) \wedge \text{Asp}^-(s, e)]$$

To sum up, affixal aspect in HU is realised on Asp^*_{hu} , which has two properties: (i) it is a transition head which marks a transition from event descriptions to situation descriptions, and (ii) it has a uniqueness requirement – the situation it creates must be unique. These two properties of Asp^*_{hu} derive truncation as a definite description of a situation. Furthermore, the uniqueness requirement on Asp^*_{hu} explains the ban on affixal aspect in constructions that describe future-oriented eventualities, where future is treated as non-deterministic.

4. Apparent counterexamples

The ban on aspectual morphology with future-oriented readings in HU has two (to our knowledge) counterexamples. The first counterexample concerns the use of epistemic *gaa*-constructions with completive compound verbs/CCVs.

With the simple perfective, epistemic *gaa*-constructions only have the past reading. Note the use of *kal* which can normally mean either ‘tomorrow’ or ‘yesterday’. In (45), *kal* can be interpreted only as ‘yesterday’ but not ‘tomorrow’. By contrast, when CCVs are used, epistemic *gaa*-constructions can receive either the past or future interpretation. *Kal* in (46) can be interpreted as ‘yesterday’ or ‘tomorrow’.

- (45) karan-ne kal khat likh-aa ho-Ø-gaa
 Karan-ERG yesterday/#tomorrow letter write-PFV.M.SG be-SBJV.3SG-MOD.M.SG
 ‘Karan must have written the letter by yesterday.’
 (Not: ‘Karan will have written the letter by tomorrow.’)

- (46) karan-ne kal khat likh li-yaa ho-Ø-gaa
 Karan-ERG yesterday/tomorrow letter write take-PFV.M.SG be-SBJV.3SG-MOD.M.SG
 ‘Karan must have written the letter by yesterday.’ Or: ‘Karan will have written the letter by tomorrow.’

The example in (46) is problematic for us because the uniqueness presupposition that comes with the perfective morphology on the light verb will not be satisfied in our system. Thus, our system predicts (46) to be ungrammatical, contrary to fact. At the moment, we do not have full understanding of why (46) is grammatical, but we believe this is due to the presence of the CCV structure. This conjecture is supported by the fact that simple epistemic *gaa*-constructions as in (45) cannot have a future reading as predicted by our system.

The second counterexample is a future-oriented reading of both simple perfective verbs and CCVs in truncated antecedents of indicative conditionals. In HU, either simple future, full past, or full present clauses can be used in the antecedent of an indicative conditional.

- (47)a. agar karan kal davaa khaa-e-gaa
 if Karan tomorrow medicine eat-SBJV.3SG-FUT.M.SG
 toh vo thiik ho jaa-ye-gaa
 thenhe alright be go-SBJV.3SG-FUT.M.SG
 ‘If Karan eats the medicine tomorrow, then he will be alright.’ (Future)
- c. agar karan-ne (sone se pehle) davaa khaa-yii
 if Karan-ERG sleep-INF from before medicine eat-PFV.F.SG
 thii toh vo thiik ho jaa-ye-gaa
 be.PST.F.SG then he alright be go-SBJV.3SG-FUT.M.SG
 ‘If Karan had eaten the medicine before sleeping, then he will be alright.’ (Past)
- c. agar karan-ne davaa khaa-yii hai toh
 if Karan-ERG medicine eat-PFV.F.SG be.PRS.3SG then
 vo theek ho jaa-ye-gaa
 he alright be go-SBJV.3SG-FUT.M.SG
 ‘If Karan has eaten the medicine, then he will be alright.’ (Present)

- d. agar karan-ne davaa khaa l-ii hai
 if Karan-ERG medicine eat take- PFV.F.SG be.PRS.3SG
 toh vo theek ho jaa-ye-gaa
 then he alright be go-SBJV.3SG-FUT.M.SG
 ‘If Karan has eaten the medicine, then he will be alright.’ (CCV-Present)

These examples are not problematic for our system as the events marked with perfective morphology in the if-clause are either present or past. When the event in the if-clause is in the future, as in (47a), no affixal aspectual morphology is used.

What is puzzling is that truncated (simple and compound) perfectives in if-clauses receive only the future-oriented interpretation (Bhatt 1997, Sharma 2010). This is illustrated in (48a) for a simple truncated perfective and in (48b) for a truncated CCV. Again note the use of *kal*, which can only mean ‘tomorrow’ in (48).

- (48)a. agar karan-ne kal davaa khaa-yii
 if Karan-ERG tomorrow/#yesterday medicine eat- PFV.F.SG
 toh vo theek ho jaa-ye-gaa
 then he alright be go-SBJV.3SG-FUT.M.SG
 ‘If Karan eats the medicine tomorrow, then he will be alright.’
- b. agar karan-ne kal davaa khaa lii
 if Karan-ERG tomorrow/#yesterday medicine eat take.PFV.F.SG
 toh vo theek ho jaa-ye-gaa
 then he alright be go-SBJV.3SG-FUT.M.SG
 ‘If Karan eats the medicine tomorrow, then he will be alright.’

Above, we presented truncation as a kind of contextual specification of a definite description of a situation. However, the examples in (48) show us that truncated structures do not have to be anchored to the world of utterance provided by the context. They can be anchored to other possible worlds and then receive a future-oriented reading.

To address the second counterexample, we need to understand truncation better. In particular, we need to understand the relationship between t- and w-parameters in case of truncation. There are two immediate possibilities: (i) they are independent of each other and (ii) possible worlds are different paths on the time tree (or different histories). In the second case, for each world (each history), future is deterministic and our second counterexample is no longer problematic.

At this point, we are not ready to provide a full account of what truncation is and what is the relationship between t- and w-parameters in the system. Further research is needed, including thorough empirical investigation. But if our observation that truncated structures are generally incompatible with the future-oriented interpretation is on the right track, accommodating if-clauses as above should not pose an insurmountable theoretical difficulty.

5. Conclusion

We made two observations about the distribution of affixal aspect in HU: (i) after affixal aspectual morphology, sentences in HU can be truncated, and (ii) affixal aspectual morphology in HU cannot appear in imperatives and simple future constructions.

Adopting a system where semantic meaning is built incrementally, we proposed that

affixal aspect in HU encodes a transition from an event description to a situation description with an additional requirement that the created situation is unique. These two conditions helped us to capture truncation as a definite description of a situation. Adding the assumption that future is non-deterministic (i.e., time is forward branching) helped us to explain why future-oriented constructions (imperatives and simple future) cannot host affixal morphology. This is because there is no unique future situation, thus the uniqueness requirement hard-wired into the meaning of affixal aspect can never be satisfied in imperative and simple future clauses.

References

- Barwise, Jon, and John Perry. 1983. *Situations and Attitudes*. Cambridge, MA: MIT Press.
- Bhatt, Rajesh. 1997. *Counterfactual morphology in modern Indo-Aryan languages: Semantics and typological issues*. Ms., University of Pennsylvania.
- Bhatt, Rajesh, and Stefan Keine. 2017. Tense and the Realization of the Feminine Plural in Hindi-Urdu. In *Perspectives on the Architecture and Acquisition of Syntax: Essays in Honor of R. Amritavalli*, ed. by Gautam Sengupta, Shruti Sircar, Madhavi Gayathri Raman and Rahul Balusu, 49–76. Singapore: Springer.
- Butt, Miriam. 2003. The light verb jungle. In: *Harvard Working Papers in Linguistics* 9, 1–49.
- Davison, Alice. 2002. Perfective aspect as underspecified past tense. Paper presented at the South Asian Languages Analysis Roundtable.
- Hinzen, Wolfram. 2006. *Mind Design and Minimal Syntax*. Oxford: Oxford University Press.
- Homer, Vincent, and Rajesh Bhatt. 2019. Licensing of PPI indefinites: Movement or pseudoscope? *Natural Language Semantics* 27(4): 279–321.
- Hook, Hook. 1973. The compound verb in Hindi. Doctoral Dissertation, University of Pennsylvania.
- Iatridou, Sabine. 2000. The grammatical ingredients of counterfactuality. *Linguistic Inquiry* 31:231–270.
- Ramchand, Gillian, and Peter Svenonius. 2014. Deriving the functional hierarchy. *Language sciences* 46:152–174.
- Ramchand, Gillian. 2018. *Situations and Syntactic Structures: Rethinking Auxiliaries and Order in English*. Cambridge, MA: MIT Press.
- Sharma, Ghanshyam. 2010. On Hindi conditionals. In *Annual Review of South Asian Languages and Linguistics*, ed. by Rajendra Singh, 107–136. Berlin, New York: De Gruyter Mouton.
- Van Der Auwera, Johan, Andrej Malchukov, and Ewa Schalley. 2009. Thoughts on (im)perfective imperatives. In *Form and function in language research: Papers in honour of Christian Lehmann*, ed. by Johannes Helmbrecht, Yoko Nishina, Yong-Min Shin, Stavros Skopeteas and Elisabeth Verhoeven, 93–106. Berlin, New York: De Gruyter Mouton

Asymmetry in Possessor-Agreement in Maithili

Preeti Kumari, Pritha Chandra
Indian Institute of Technology Delhi

Abstract

This paper presents novel data from external possession construction in Maithili, an Eastern Indo-Aryan language. Maithili external possession is different from those reported in the literature as it allows only 2nd person and 3rd person honorific possessors to trigger agreement. Additionally, possessum agreement shows a subject-object asymmetry such that only possessums inside subjects trigger agreement, whereas possessums in objects fail to do so. This paper shows that these asymmetries in possessor and possessum agreement result from the need to value the [Addressee] and the [Honorific] features on the 2nd and 3rd person DPs, respectively.

Keywords: External Possession, Internal Possession, Honorificity, Addressee, Maithili

1. Introduction

Cross-linguistically, possessive constructions are of two types- ‘Internal’ and ‘External’. Internal possession is where the possessor gets a genitive DP. There is no case/agreement dependency between the possessor and the verb. See (1) from Japanese, where the possessor is assigned genitive case inside the DP. The possessum noun on the other hand is valued nominative by the T head.

- (1) [*Mary-no kami-ga naga-i*
 Mary-GEN hair-NOM long-be
 ‘Mary’s hair is long’ (Japanese, Ura 1996:100b)

External possession is where the possessor and the predicate form a case/agreement dependency. Both the possessum and the possessor nouns in (2) get nominative case. Additionally, the possessor noun gets an additional theta role of *affectee*, which it does not have in (1).

- (2) [*Mary-ga kami-ga naga-i*
 Mary-NOM hair-NOM long-be
 ‘Mary’s hair is long’ (Japanese, Ura 1996:100a)

External possession may also show up in agreement, as illustrated in the Nez Perce sentence in (3). In addition to the possessor getting the object case, the number (plural) feature of the possessor noun is also encoded on the verb. In contrast to Japanese, the possessor noun in Nez Perce does not get an additional theta role despite being external possession.

- (3) *Haama-pim hi-nees-wewkuny-e’ny-Φ-e* [*ha-haacwal-na lawtiwaa*
 man-ERG 3SUBJ-**OBJ.PL**-meet-μ-p-rem.PST **PL-boy-obj** friend.NOM
 ‘The man met the boys’ friend.’ (Nez Perce, Deal 2013: 2)

Thus, what is common to Japanese and Nez Perce is that in external possession, the possessor is case valued by the v/T head, and subsequently, agrees with it. In this paper, we present an instance of obligatory external possession from Maithili where the possessor gets a DP-internal genitive case, and yet it triggers verbal agreement, along with the possessum noun (4).

- (4) [*hun-kār beta*] *sut-əl* *chh-əl-əinh*
 He.H-GEN son.NH sleep-PRF be-pst-3.H+3.NH
 ‘His son had slept’

Maithili therefore behaves like an internal possession language with respect to subject case assignment, and like an external possession language for verbal agreement. A second distinct property is that only 2nd person and honorific 3rd person possessors trigger verbal agreement in Maithili. 1st person and non-honorific 3rd person possessors fail to trigger verbal agreement in the language. A final property is that it shows subject-object asymmetry in these constructions. To elaborate, when the possessive DP is in the subject position of an intransitive or a transitive verb, both the possessor (2nd and honorific 3rd person only) and the possessum nouns trigger verbal agreement. Whereas, when the possessive DP is in the object position of a transitive verb, only the possessor triggers verbal agreement, along with the subject. The possessum fails to control verbal agreement. The subject-object asymmetry is schematized in (5).

- (5) a. On intransitive verbs (external possession):
 [[_{subj} **2nd person/3rd person H-Possessor**_i **Possessum**_j] **Verb**_{i+j}]
 b. On transitive verbs with possessive subjects (external possession):
 [[_{subj} **2nd person/3rd person H-Possessor**_i **Possessum**_j] [_{obj} DP]_k **Verb**_{i+j}]
 c. On transitive verbs with possessive objects (external possession):
 [[_{subj} DP]_i [_{obj} **2nd person/3rd person H-Possessor**_j **Possessum**_k] **Verb**_{i+j}]

Based on these unique and interesting patterns of internal and external possession in Maithili, we ask the following questions in this paper:

- (6) a. If the possessor DP is already case-marked genitive within the DP, how does it obviate the ‘Activity Condition’ (Chomsky 2000, 2001) and trigger agreement with the auxiliary?
 b. What is the role of the person and honorificity features on the 2nd and 3rd person possessors, which makes agreement with them obligatory?
 c. What explains the subject-object asymmetry in possessum agreement?

We propose that the 2nd and 3rd person honorific possessors are active in syntax due to their [Addressee] and [Honorific] features. The 2nd person possessors move from their base-generated position to Spec TP/vP, so that their [Addressee] feature can be valued by the addressee in the left-periphery of the clause (following Baker 2008). Similarly, the 3rd person possessors move to Spec, TP/vP so that their [Honorific] feature can be valued by the speaker in the left-periphery of the clause (following Portner, Pak and Zanuttini 2019 and Alok 2020, 2021). As for the subject-object asymmetry in possessum agreement, we claim that due to the possessors moving outside of their base-generated position, the probes on the T head, which is the locus of possessor agreement, never encounter the object possessum. Subject possessum, on the other hand, is always closer to the T head and thus, always triggers agreement with it.

The organisation of the paper is as follows. In section 2, we present the basic agreement facts of Maithili. In section 3, we present the possessor agreement paradigm of Maithili. Section 4 is our analysis of Maithili possessor agreement. Section 5 concludes the paper.

2. Maithili: Basic Facts

Maithili is an Eastern Indo-Aryan language. The 2nd and 3rd person pronouns in Maithili encode various layers of honorificity, as shown in Table 1, whereas the 1st person pronoun does not encode honorificity. The 2nd person pronouns are classified as non-honorific (NH), mid-honorific (MH), honorific (H), high-honorific (HH) and honorific-distant (HD).¹ The 3rd person pronouns are classified into two categories- non-honorific and honorific.²

Table 1. Maithili Pronouns

| | |
|-------|-------------|
| 1P | <i>həm</i> |
| 2P NH | <i>tõ</i> |
| 2P MH | <i>tõ</i> |
| 2P H | <i>əhã</i> |
| 2P HH | <i>əpne</i> |
| 2P HD | <i>i</i> |
| 3P NH | <i>o</i> |
| 3P H | <i>o</i> |

We now present the subject and object agreement patterns, as triggered by these pronouns, in sections 2.1 and 2.2, respectively.

2.1. Maithili Subject Agreement

The 1st person pronouns in Maithili only trigger person agreement as there is no honorificity distinction in the 1st person.

- (7) *həm sut-əl chh-əl-iãi.*
 I sleep-PRF be-PST-1
 ‘I had slept.’

The 2nd person pronouns trigger both person and honorificity agreement, as shown in (8).

- (8) a. *tõ sut-əl chh-əl-æ.*
 you.NH sleep-PRF be-PST-2.NH
 b. *tõ sut-əl chh-əl-əh.*
 you.MH sleep-PRF be-PST-2.MH

¹ The 2nd person non-honorific pronoun is used for an addressee who is socially subordinate to the speaker such as a younger sibling; the mid-honorific pronoun is used for someone who is subordinate in terms of age or position, but holds respect in the society otherwise such as grown-up sibling/nephew/niece; the honorific pronoun is used for a superior addressee in an informal set-up such as parents; the high-honorific pronoun is used for a superior addressee in a formal set-up such as teachers; the honorific-distant pronoun is a special pronoun which is used only for in-laws.

² Just like the 2nd person non-honorific, the 3rd person non-honorific pronoun is also used for someone who is socially subordinate, and the honorific pronoun is used for someone who is socially superior. Unlike the 2nd person, the 3rd person does not encode a vast range of honorificity/formality distinction.

| | | | |
|----|------------------|---------------|---------------------|
| c. | <i>əhã</i> | <i>sut-əl</i> | <i>chh-əl-əũh.</i> |
| | you.H | sleep-PRF | be-PST-2.H |
| d. | <i>əpne</i> | <i>sut-əl</i> | <i>chh- əl-əũh.</i> |
| | you.HH | sleep-PRF | be-PST-2.HH |
| e. | <i>i</i> | <i>sut-əl</i> | <i>chh- əl-əth.</i> |
| | you.HD | sleep-PRF | be-PST-2.HD |
| | ‘You had slept.’ | | |

The 3rd person pronouns also trigger person and honorificity agreement on the verb. The non-honorific 3rd person agreement is shown in (9), and the honorific 3rd person agreement is shown in (10).

| | | | |
|-----|---------------|---------------|-------------------|
| (9) | <i>o</i> | <i>sut-əl</i> | <i>chh-əl-əi.</i> |
| | s/he.NH | sleep-PRF | be-PST-3.NH |
| | ‘S/he slept.’ | | |

| | | | |
|------|---------------|---------------|----------------------|
| (10) | <i>o</i> | <i>sut-əl</i> | <i>chh-əl-khinh.</i> |
| | s/he.H | sleep-PRF | be-PST-3.H |
| | ‘S/he slept.’ | | |

2.2. Multiple Agreement in Maithili

Maithili is a multiple agreement language where objects also trigger verbal agreement. However, object agreement is restricted to 2nd person (all values) and honorific 3rd person DPs. For illustration, consider the examples presented in (11a-b), where the subjects are 2nd person non-honorific and mid-honorific pronouns, respectively. The object in these sentences is 1st person. Interestingly, the verbal morphology is that of an intransitive verb with a 2nd person non/mid-honorific noun (compare with 8a-b). 1st person object in (11) clearly fails to trigger verbal agreement.

| | | | | | |
|------|----|---------------|---------------|----------------|-------------------|
| (11) | a. | <i>tõ</i> | <i>hum-ra</i> | <i>dekh-ne</i> | <i>chh-əl-ə.</i> |
| | | you.NH | I-ACC | see-PRF | be-PST-2.NH |
| | b. | <i>tõ</i> | <i>hum-ra</i> | <i>dekh-ne</i> | <i>chh-əl-əh.</i> |
| | | you.MH | I-ACC | see-PRF | be-PST-2.MH |
| | | ‘You saw me.’ | | | |

By contrast, 2nd person objects trigger person and honorificity agreement. This is illustrated through distinct verbal morphology in sentences in (12) where the subject is 1st person, and the objects are 2nd person non-honorific and mid-honorific pronouns, respectively.

| | | | | | |
|------|----|------------|---------------|----------------|-------------------|
| (12) | a. | <i>həm</i> | <i>to-ra</i> | <i>dekh-ne</i> | <i>chh-əl-iəu</i> |
| | | I | you.NH-ACC | see-PRF | be-PST-1+2.NH |
| | b. | <i>həm</i> | <i>to-ra</i> | <i>dekh-ne</i> | <i>chh-əl-iəh</i> |
| | | I | you.MH-ACC | see-PRF | be-PST-1+2.MH |
| | c. | <i>həm</i> | <i>ahã-ke</i> | <i>dekh-ne</i> | <i>chh-əl-əũh</i> |
| | | I | you.H-ACC | see-PRF | be-PST-1+ 2.H |

- d. *həm apne-ke dekh-ne chh-əl-əũh*
 I you.HH-ACC see-PRF be-PST-1+ 2.HH
- e. *həm hin-ka dekh-ne chh-əl-iəinh*
 I you.HD-ACC see-PRF be-PST-1+2.HD
 ‘I had seen you.’

Moving on, while 3rd person non-honorific objects fail to trigger verbal agreement, 3rd person honorific objects do. Consider (13), which shows that a transitive verb with a 3rd person non-honorific object and a 1st person subject has the same verbal morphology as an intransitive verb with a 1st person subject (compare 13 with 7).

- (13) *həm ok-ra dekh-ne chh-əl-iəi.*
 I s/he.NH-ACC see-PRF be-PST-1+3.NH
 ‘I had seen her/him.’

On the other hand, a verb with a 3rd person honorific object has distinct verbal morphology also encoding the person and honorificity agreement of the object (14).

- (14) *həm hun-ka dekh-ne chh-əl-iəinh.*
 I he.H-ACC see-PRF be-PST-1+3.H
 ‘I saw him.’

The subject and object agreement paradigm of Maithili is summarised in Table 2.

Table 2: Maithili Agreement Patterns

| | Subject | Object |
|--------------------------------|--------------------------------------|--------------------------------------|
| 1st person | Yes- person agreement | No agreement |
| 2nd person (NH, MH, H, HH, HD) | Yes- person + honorificity agreement | Yes- person + honorificity agreement |
| 3rd person NH | Yes- person + honorificity agreement | No agreement |
| 3rd person H | Yes- person + honorificity agreement | Yes- person + honorificity agreement |

3. Possession in Maithili: Structure and Agreement

Having presented the inflectional paradigm of Maithili, we now introduce the agreement observed in Maithili possessive constructions. The possessor in Maithili is genitive marked, showing traits of internal possession, as the genitive case can only be assigned DP internally (Abney 1987).

- (15) *hun-kər bəcca*
 s/he(H)-GEN child(NH).NOM
 ‘His/her child’

However, the 2nd and 3rd person possessors trigger obligatory verbal agreement, as shown in (16-17), thus behaving like an external possession language.

(16) [*toh-ər* *beta*] *sut-əl* *chh-əl-əu*
 you.NH-gen son.NH sleep-PRF be-pst-2.NH+Default
 ‘Your son had slept.’

(17) [*hun-kər* *beta*] *sut-əl* *chh-əl-əinh*
 you.NH-gen son.NH sleep-PRF be-pst-3.NH+Default
 ‘Your son had slept.’

We present further details of external possession in the following sub-sections.

3.1. External Possession in Intransitive Constructions

Maithili allows the 2nd person (all values) and 3rd person honorific possessors to trigger person and honorificity agreement. As opposed to the 2nd and honorific 3rd person, the 1st person possessors fail to trigger verbal agreement (18). Compare the agreement morphology in (18) with that of (10).

(18) [*həmm-ər* *baba*] *sut-əl* *chh-əl-khinh*.
 I-GEN grandfather.H sleep-PRF be-pst-3.H
 ‘My grandfather had slept.’

2nd person possessors trigger agreement in addition to the possessum noun, as shown in (19).

(19) a. [*toh-ər* *beta*] *sut-əl* *chh-əl-əu*.
 you.NH-GEN son.NH sleep-PRF be-pst-2.NH+3.NH
 ‘Your son had slept.’
 b. [*ahā-ke* *beta*] *sut-əl* *chh-əl-ah*.
 you.H-GEN son.NH sleep-PRF be-pst-2.H+3.NH
 ‘Your son had slept.’

Similarly, the 3rd person honorific possessors also trigger verbal agreement (20).

(20) [*hun-kər/master-sahab-ke* *beta*] *sut-əl* *chh-əl-əinh*.
 he.H-gen/teacher-sir-GEN son.NH sleep-PRF be-PST-3.H+3.NH
 ‘His son had slept/the teacher’s son had slept.’

3rd person non-honorific possessors, on the other hand, fail to trigger verbal agreement.

(21) [*ok-ər* *beta*] *sut-əl* *chh-əl-ai*.
 s/he.NH-GEN son.NH sleep-PRF be-PST-3.NH
 ‘Her/his son had slept.’

It is important to note that the possessum noun always triggers agreement along with possessor nouns (22).

- (22)a. [*ahā-ke baba*] *sut-əl* *chh-əl-əinh.*
 you.H-GEN grandfather.H sleep-PRF be-PST-2.H+3.H
 ‘Your grandfather had slept’
- b. [*ahā-ke master-saab*] *sut-əl* *chh-əl-əinh.*
 you.H-GEN teacher-sir.H sleep-PRF be-PST-2.H+3.H
 ‘Your grandfather had slept.’

Thus, to summarise, only the 2nd and 3rd person honorific possessors trigger verbal agreement, just like the objects. Possessums also trigger agreement.

3.2. External Possession in Transitive Constructions

In this section, we show how the possessive construction show asymmetry in possessum agreement depending on their syntactic position.

3.2.1. Subject Possessive DPs

So far, we have looked at possessive constructions only with intransitive verbs. We now look at the possessive constructions with transitive verbs where there can be three agreement controllers- the possessor and the possessum and the object. Let us first look at possessive DPs in the subject position of a transitive verb. Just like the intransitive constructions, the possessor triggers agreement when it is 2nd person or 3rd person honorific, as shown in (23-24). In both cases, the possessum noun also triggers simultaneous verbal agreement.

- (23) [*toh-ər beta*] [*ok-ra*] *dekh-ne chh-əl-əu.*
 you.NH-GEN son.NH s/he.NH-ACC see-PRF be-PST-2.NH+3.NH
 ‘Your son had seen him/her.’
- (24) [*hun-kar bəta*] [*ok-ra*] *dekh-ne chh-əl-əinh.*
 s/he.H-GEN son.NH s/he.NH-ACC be-PRF be-PST-3.NH+3.NH
 ‘His/her son had seen him/her.’

The examples show that possessor agreement wins over object agreement when the former is 2nd person or 3rd person honorific. If we switch the person and honorificity values of the possessor and the object, we see that it is the object that wins over possessor agreement. For instance, when the possessor is 1st person or 3rd person non-honorific and the object is 2nd person or 3rd person honorific, then we see object agreement.

- (25)a. [*həmm-ər baba*] *to-ra* *dekh-ne chh-əl-khunh.*
 I-GEN grandfather.H you.NH-ACC see-PRF be-PST-3.H+2.NH
 ‘My grandfather had seen you.’
- b. [*ok-kar baba*] *to-ra* *dekh-ne chh-əl-khunh.*
 I-GEN grandfather.H you.NH-ACC see-PRF be-PST-3.H+2.NH
 ‘My grandfather had seen you.’
- (26) [*ok-kar baba*] *ahā-ke* *dekh-ne chh-əl-əinh.*
 I-GEN grandfather.H you.H-ACC see-PRF be-PST-3.H+2.H
 ‘My grandfather had seen you’

When the possessor does not trigger verbal agreement, the agreement is just controlled by the subject. See (31), where only the 1st person subject triggers agreement.

- (31) *hum* [ok-kar baba-ke] *dekh-ne* *chh-al-iai*
 I s/he.NH-GEN grandfather.H-ACC see-PRF be-PST-1
 ‘I had seen his/her grandfather.’

Therefore, the possessor DP in the object position always triggers agreement if it is 2nd person and 3rd person honorific. The possessum in the object position never controls agreement.

To summarise section 3, we have described three crucial properties of Maithili possessive constructions: i) Maithili has internal possession inside the DP as the possessors get a genitive case; verbal agreement, however, behaves like external possession as the 2nd and 3rd person honorific possessors trigger agreement. ii) In the subject position, external possession is coupled with possessum agreement. iii) In the object position, the possessum never controls verbal agreement.

4. Analysis

This distribution of external possession in Maithili raises the following questions:

- (32)
- i. If the possessor DP is already case-marked genitive within the DP (internal possession), how does it obviate the ‘Activity Condition’ (Chomsky 2000, 2001) and trigger agreement with the auxiliary (external possession)?
 - ii. What is the role of the person and honorificity features on the 2nd and 3rd person possessors, which makes agreement with them obligatory?
 - iii. What explains the subject-object asymmetry in possessum agreement?

In this section, we answer these questions.

4.1. The Activity Condition

We have seen that Maithili possessors are marked with the genitive case, which is assigned by the D head in the DP structure, as shown in (33).

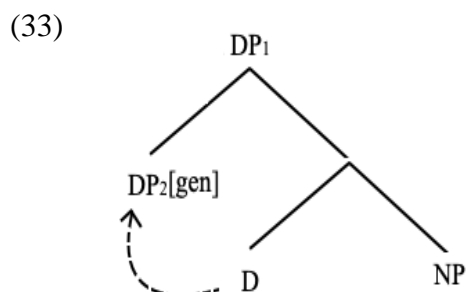

Possessor agreement in Maithili, on the other hand, happens with the T head, as visible from the agreement morphology, which appears on the auxiliary. This means that Maithili possessors get case from one functional head, D, but agree with another functional head, T. The disjunction

of case and agreement in Maithili external possession is a violation of the Activity Condition (AC), which is defined as follows:

(34) *Activity Condition (Chomsky, 2001, 6):*

“Probe and goal must both be active for Agree to apply . . . For the Case-agreement systems, the uninterpretable features are φ -features of the probe and structural Case of the goal N. φ -features of N are interpretable; hence, N is active only when it has structural Case. Once the Case value is determined, N no longer enters into agreement relations and is frozen in place.”

As per (34), possessors should be inactive after case-valuation by d. We claim that they are not and instead are re-activated due to extra features such as [Addressee] or [Honorific]. This means that 2nd person DPs and 3rd person DPs remain active due to the [Addressee] and [Honorific] features, respectively.³ The question now arises, what is it about the [Addressee] and the [Honorific] features that keeps the possessors carrying them active for verbal agreement, despite them getting a genitive case inside the DP? We explain below.

4.1.1. On the [Addressee] feature and 2nd Person Possessor Agreement

We follow Baker (2008) in assuming that all 2nd person DPs must be bound by the speech addressee, present in the left periphery of the clause, in Spec, SAP. However, possessors are not part of the main clause, as shown in (33). This means that for a 2nd person possessor to be bound by the addressee in Spec, SAP, it must come to a position from where it is visible to it. For instance, if the possessive DP is in the subject position, then a 2nd person possessor DP must move to Spec, TP because of the [Addressee] feature it encodes. The [Addressee] needs to be bound by the addressee in Spec, SAP.

Following Deal (2017), we present two pieces of evidence favouring the 2nd person possessor raising to a higher position. The first piece of evidence shows that the possessor can be displaced, breaking the DP constituency (35).

- (35) *toh-ar* *sut-al* *chh-al-au* *beta.*
 you.NH-GEN sleep-PRF be-pst-2.NH+3.NH son.NH
 ‘Your son had slept.’

The second piece of evidence in favour of possessor raising is its obligatoriness. Note that languages like Japanese have optional external possession. It has been noted that when Japanese shows external possession, the possessor receives an additional theta role of ‘affectee’. Thus, the possessor moves only when the ‘affectedness’ of the possessor has to be expressed. When the possessor remains unaffected by the event, there is no need for possessor movement and hence, the result is internal possession (Vergnaud and Zubizarreta 1992, Koenig 1999, Nakamoto 2010, Kempchinsky 1992, Sanchez López 2007). In contrast, possessor raising in obligatory external possession languages like Nez Perce does not involve an additional theta

³ It has been reported in the literature that the Activity Condition (AC) must be diluted and viewed as a macro-parameter (Baker 2008) or a micro-parameter (Oxford 2017), instead of a universal principle. In fact, Halpert (2019) goes as far as to claim that the AC must be eliminated from syntax. Since Maithili allows very few pronouns to remain active after case assignment, namely 2nd person and 3rd person honorific, we cannot, at this moment, take a position on eliminating AC from the grammar. We leave this question to future enquiry.

role. The possessor moves to a non-theta position in Nez Perce due to case requirements, and as a result, external possession is the only way in the language.

Just like Nez Perce, external possession is obligatory in Maithili when the possessor is 2nd person, as shown in (36). This means that the possessors move outside of their base-generated position, irrespective of their affectedness.

- (36) **[toh-ar beta] sut-al chh-al-ai.*
 you.NH-GEN son.NH sleep-PRF be-pst-3.NH
 ('Your son had slept.')

Based on these two pieces of evidence – constituency and obligatory external possession – we claim that the 2nd person possessors in Maithili move out of the possessive DP due to the [Addressee] features.

Now that we have a motivation for possessor movement, we elaborate on the agreement mechanism. Once the 2nd person possessor moves to Spec, TP, it gets probed by the T head resulting in external possession. However, it is to be noted that Maithili also has simultaneous possessum agreement. To accommodate the possessor + possessum agreement, we adopt the multiple agreement system developed by Georgi (2012, 2013), which proposes that languages with multiple agreement have two probes on the T head, which agree with two goals in the clause. Therefore, our derivation for external possession in Maithili with a 2nd person possessor, along with possessum agreement, involves the following steps: i) the possessor moves out of its base generated position to Spec, TP. ii) The probes p1 and p2 on the T head agree with the subject possessum and the moved possessor, respectively. This agreement mechanism is presented in (37).

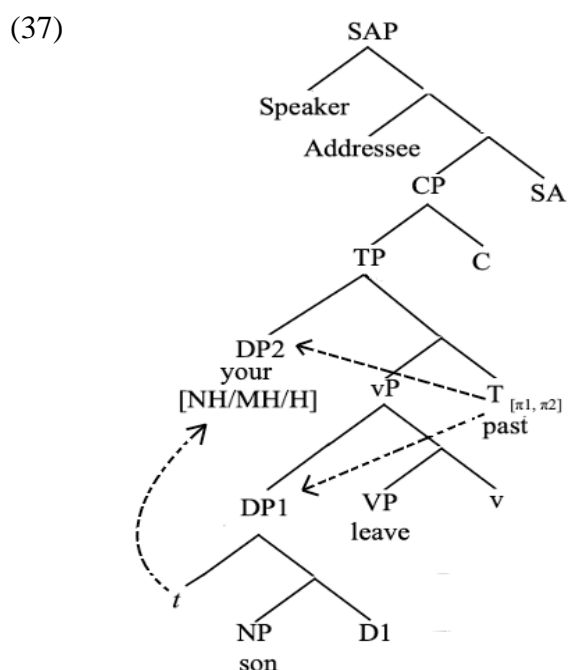

4.1.2. On the [Honorific] feature and 3rd Person Honorific Possessor Agreement

In this section, we show that just like the [Addressee] feature on the 2nd person possessors that forces them to move out of their base-generated position, the [Honorific] feature on the 3rd person possessor also results in possessor movement.

It has been reported in the literature that the honorificity feature is relational, meaning its values are always decided in relation to the speaker (Portner, Pak and Zanuttini 2019 and Alok 2020, Chandra, Kumari and Pak 2021, Kumari 2021). For this valuation to happen, DPs with the honorificity feature must be bound by the speaker in the left periphery. For the DPs that are present in the main clause, this binding can be achieved easily. For possessor DPs on the other hand, binding by the speaker would require them to move out of their base-generated positions. Since the 1st person DPs do not encode the honorificity feature, they never move out, and as a result, we do not see 1st person possessor agreement. The 2nd person DPs, as shown in section 4.1.1, move out of their base-generated position due to their [Addressee] feature. The 3rd person honorific DP, similarly, moves out because of their [Honorific] feature, so that it can be bound by the speaker in the left periphery.

In Portner et al.'s work, both the non-honorific and the honorific features are on a DP are a result of binding by the speaker. In Maithili, however, we see that only the [Honorific] feature requires this binding as only the 3rd person honorific possessors move out of their base-generated position to trigger verbal agreement. We show this agreement mechanism in (38).

(38)

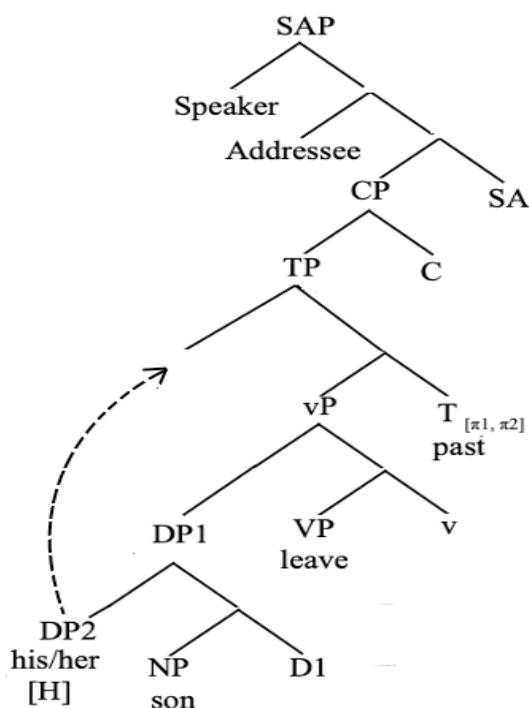

We present the two pieces of evidence that support the raising of the 3rd person honorific possessor. The first evidence is that the constituency of the possessive DP does not hold, as illustrated in (39).

- (39) *hun-kar sut-əl chh-əl-əinh beta.*
 s/he.H-GEN sleep-PRF be-pst-3.H+3.NH son.NH
 ‘His/her son had slept.’

The second piece of evidence in support of the 3rd person possessor raising is its obligatoriness, shown in (40).

- (40) **[hun-kar beta] sut-əl chh-əl-əi.*
 s/he.H-GEN son.NH sleep-PRF be-PST-3.NH
 ('His/her son had slept.')

As for the agreement mechanism, it remains the same as 2nd person possessor agreement. Once the 3rd person honorific DP is in Spec, TP, it gets probed by the T head. In addition to the possessor, the possessum noun also gets probed by T as it has two probes (see 37 again).

Just like what we have shown for subject possessor agreement, we suggest that the object possessors also move to Spec, TP for [Addressee] or [Honorific] feature valuation and result in verbal agreement. One piece of the puzzle that remains unsolved at the moment is the optional possessor agreement, shown in (28). When the possessor is 3rd person honorific, and the object is 2nd person, either of them may trigger verbal agreement. We do not have a definite answer for this optionality, and therefore tentatively add that additional factors, such as the speaker's intent to acknowledge the addressee's social status, may have a role to play in this optionality. We base our suggestion on the ground that Maithili is an allocutive agreement language. However, allocutivity is encoded optionally in Maithili, depending on the speaker's intent to address the addressee's presence. In cases like (28), if the speaker intends to acknowledge the addressee, the object must trigger agreement. However, if the speaker intends not to do it, the 3rd person honorific possessor triggers agreement. Further inquiry in this issue is needed.

4.2. Subject-Object Asymmetry

So far, we have shown that the 2nd and 3rd person honorific possessors must move out of their base-generated position. When the possessive DP is in the subject position, this movement happens to the Spec, TP. When the possessive DP is in the object position, this movement happens to Spec, vP. Movement outside of the object position to Spec, vP makes the possessor DP closer to the T head than the object. The subject is, anyway, the closest argument. As a result, we see that in object possessive constructions, verbal agreement is controlled by the subject and the possessor and not the possessum (41).

(41)

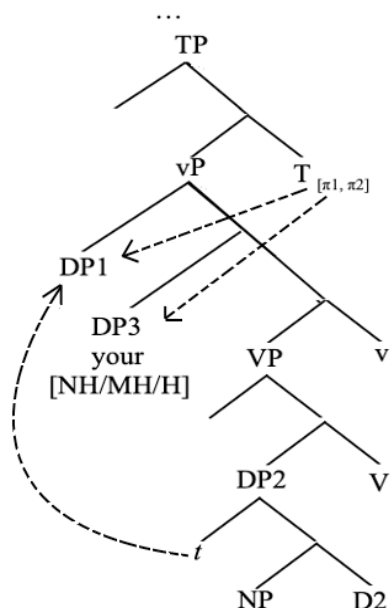

Based on the structure in (41), we predict that if the possessive DP is the direct object of a ditransitive verb, its possessor should not raise, as the indirect object will intervene. As such, we do not expect the constituency to break. This prediction is borne out, as the constituency of a possessive DP in the DO position, shown in (42), cannot be broken due to the presence of the indirect object, shown in (43).

(42) *hum raam-ke sita-k bacha-ke de-l-iəi*
 I Raam-DAT Sita-GEN child-ACC give-PRF-1
 ‘I gave Sita’s child to Raam’

(43) **hum sita-k raam-ke bacha-ke de-l-iəi*
 I Sita-GEN Raam-DAT child-ACC give-PRF-1

The crucial question, however, is that even when the object possessor does not control verbal agreement, i.e., when the possessors fail to move outside the possessive DPs, the object possessum does not control agreement. We claim that since the object possessum is in the complement to V position, it is outside the probing domain of the T head.

6. Conclusion

This paper has shown that just like external possession is driven by semantic reasons of affectedness in Japanese and case in Nez Perce, it is driven by the [Addressee] and the [Honorific] features in Maithili. The need to license these features forces the 2nd person and 3rd person honorific possessors to move out of their base-generated position to Spec, TP/vP, from where they can be easily probed by the T head.

References

- Abney, Steven Paul. 1987. *The English Noun Phrase in Its Sentential Aspect*, Doctoral dissertation, MIT.
- Alok, Deepak. 2020. *Speaker and Addressee in Natural Language: Honorificity, Indexicality and their Interaction in Magahi*. PhD Dissertation, Rutgers University.
- Baker, Mark. 2008. *The Syntax of Agreement and Concord*. Cambridge: Cambridge University Press.
- Chandra, Pritha, Preeti Kumari & Miok Pak (2021). 3rd Person is Person too: Evidence from Honorific Constructions. In Tae Sik Kim & Suyoung Bae (eds.), *Proceedings of SICOOG* 23, 12–15.
- Chomsky, Noam. 2000. Minimalist inquiries: the framework. In *Step by step: Essays on minimalism in honor of Howard Lasnik*, ed. Roger Martin, David Michaels, and Juan Uriagereka. Cambridge, Mass.: MIT Press.
- Chomsky, N. 2001. Derivation by phase. In *Ken Hale: A life in language*, ed. M. Kenstowicz, 1–52. Cambridge, MA: MIT Press.
- Deal, Amy Rose. 2013. Possessor Raising. *Linguistic Inquiry*, 37: 391–432.
- Deal, A. R. 2017. External possession and possessor raising. In *The Wiley Blackwell Companion to Syntax*, Wiley-Blackwell.
- Georgi, D. 2012. A relativized probing approach to person encoding in local scenarios. *Linguistic Variation*.
- Georgi, D. 2013. Deriving the Distribution of Person Portmanteaux by Relativized Probing. In *Proceedings of NELS 42*, ed. S. Keine & S. Sloggett, 155–168. Amherst, MA: GLSA.
- Halpert, Claire. 2019. Raising unphased. *Natural Language and Linguistic Theory* 37:123–165.
- Kempchinsky, Paula. 1992. The Spanish Possessive Dative Construction: θ -Role Assignment and Proper Government. In *Romance Languages and Modern Linguistic Theory*, edited by Paul Hirschbühler and E. F. K. Koerner, 135–149. Amsterdam: John Benjamins.
- Koenig, Jean-Pierre. 1999. French Body-Parts and the Semantics of Binding. *Natural Language and Linguistic Theory*, 17: 219–265.
- Kumari, Preeti. 2022. Portmanteau Honorificity Agreement in Maithili. In *the Proceedings of the 11th Formal Approaches to South Asian Languages (FASAL)*, (eds.) Samir Alam, Yash Sinha, Sadhwi Srinivas.
- Nakamoto, Takeshi. 2010. In alienable possession constructions in French. *Lingua* 120:74–102.
- Oxford, Will. 2017. The Activity Condition as a microparameter. *Linguistic Inquiry* 48:711–722.
- Portner, Paul, Miok Pak & Raffaella Zanuttini. 2019. The speaker-addressee relation at the syntax-semantics interface. *Language* 95(1), 1-36.
- López, C. S. 2007. The possessive dative and the syntax of affected arguments. *Cuadernos de lingüística del IUI Ortega y Gasset*, 14, 153-173.
- Ura, Hiroyuki. 1996. *Multiple Feature-Checking: A Theory of Grammatical Function Splitting*. PhD diss., MIT.
- Vergnaud, Jean-Roger and Maria Luisa Zubizarreta. 1992. The Definite Determiner and the Inalienable Constructions in French and in English. *Linguistic Inquiry*, 23: 595–652.

Processing of Honorific Agreement in Korean

So Young Lee, Myung Hye Yoo

Miami University, National University of Singapore

1. Introduction

A unique property of human language is its ability to combine contingent lexical elements into hierarchically organized sentence structures, where those dependent elements can appear linearly adjacent or far away from each other. One case example is subject-verb agreement as in (1). In many languages including English, in order to formulate a grammatical sentence, a subject and a verb need to agree with each other in one or more of morphosyntactic features such as numbers, genders, and person features.

- (1) a. The *key* *was* rusty.
b. The *key* to the cabinets in the copy room *was* rusty.

For the successful comprehension, a parser must accurately identify the verb *was* and its licit subject *key* to link them, regardless of the distance between the verb and the subject. A central focus of research on dependencies, therefore, has been on how a parser resolves the dependency during real-time processing and how the different levels of linguistic information affect that resolution. In recent studies on subject-verb agreements, discussions have been developed based on the assumption that when a parser encounters a verb, it retrieves the structure already processed, in order to access a proper subject. However, since most of the previous studies have been on a typologically limited set of languages (i.e. Indo-European languages including English), it is hard to say that subject-verb agreements are universally based on retrieval processing. The current study, therefore, examines the processing of a dependency of subject-verb honorific agreement in Korean, which is a typologically different language from those previously studied to investigate crosslinguistic generality of retrieval processes by focusing on the attraction effect.

This paper is structured as follows. In section 2, we will briefly sketch the Korean honorific agreement system, the attraction effect, and the parsing strategies. Section 3 presents the details of the experiments. In section 4, we provide the experimental results and brief discussion based on the results. Section 5 offers concluding remarks.

2. Background

2.1 Honorific agreement

In Korean, honorifics (e.g. *-nim* ‘honorable’ on the nouns and *-si* ‘honorific marker’ on the verb) are used to express respect to a referent or an addressee. The honorifics are a quite morphosyntactically and pragmatically productive device signaling social status of the sentential subject relative of that of a speaker in Korean. Even though Korean does not have a strong subject-verb agreement system shown in Indo-European languages, honorifics on a subject and a verb can form systematic dependency relations (Brown 2015, Sohn 1999). For instance, the honorific suffix cannot be compatible with a subject of low social status, such as *ai* ‘kid’ (2a) so the existence of the affix *-si* on the verb induces ungrammaticality. In other

words, the affix *-si* requires an honorable subject that can be associated. For instance, the honorific affix *-si* attaches to a verbal stem and agrees with an honorable subject, such as *sensayng-nim* ‘teacher’ as shown in (2b). Note that the honorific affix *-si* on the verb is used optionally. Since it is not required for the grammaticality, depending on the social contexts, the affix *-si* is often omitted.

- (2) a. ai-ka hakkyo-ey ka-ss-ta / *ka-si-ess-ta
 kid_{NOM} school_{LOC} GO-PAST-DEC / GO-HON-PAST-DEC
 ‘The kid went to school.’
- b. sensayng-nim-i hakkyo-ey ka-ss-ta / ka-si-ess-ta
 teacher_{HON-NOM} School_{LOC} GO-PAST-DEC / GO-HON-PAST-DEC
 ‘The teacher went to school.’

Even though the Korean honorific system is different from that of the subject-verb number agreement in English in that it is not grammatically motivated, it still involves a kind of subject-verb agreement in that the subject must have an honorific feature in the presence of the affix *-si* on the verb. So far, very few studies have investigated the processing of Korean honorific agreements. Thus, this study examines Korean speaker’s processing of honorific agreements by focusing on the attraction phenomenon.

2.2 Attraction effect

Numerous previous psycholinguistics studies including Lago et al. 2015, Pearlmutter et al. 1999 and Wagers et al. 2009 reported the attraction effect on long-distance dependencies including subject-verb agreement. Attraction effects occur when potential items instead of a target item are erroneously activated in the retrieval processes. For example, in the processing of subject-verb agreement, Pearlmutter et al. (1999) found that even though the intervening attractor (such as *the cabinets* in (3d)) is grammatically irrelevant for the subject-verb agreement, it does reduce processing difficulty (as shown in comparison to 3c)).

- (3) a. The key to the cabinet was rusty after many years of disuse.
 b. The key to the cabinets was rusty after many years of disuse.
 c. *The key to the cabinet were rusty after many years of disuse.
 d. *The key to the cabinets were rusty after many years of disuse.

Consequently, English speakers spent less time reading (3d) than reading (3c), although both are ungrammatical, indicating that their computation of the subject-predicate agreement was affected by the intervening attractor. This attraction effect has drawn a lot of attention to psycholinguists, since it provides important insights into human language processing mechanisms.

2.3 Retrieval processing vs. Active Filler processing

For the dependency resolutions, there are two main parsing strategies that have been proposed. One is the retrieval processing and the other is the active filler processing. The main difference between these two is the directionality. The retrieval processing has been assumed in the dependency resolutions such as morphosyntactic agreements. As in the configuration (4) where two items are dependent for the number agreement, when the dependent element (e.g., was)

that linearly appears later in the sentence is encountered, a parser starts to search the other lexical item (e.g., the key) that is already processed.

(4) The key_{subject} ... was ...



If this parsing strategy is applied to Korean honorific agreements, we expect that the retrieval happens when the parser encounters the honorific affix on the verb as in (5).

(5) Subject-honorific ... Verb-honorific

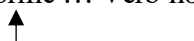

An alternative parsing strategy is the active filler strategy. The active filler processing (Frazier & Clifton 1989) has been developed based on the filler-gap dependencies. As soon as a filler is identified, a parser initiates a search for a gap. This active filler strategy has been understood as a descriptive generalization that should ultimately be explained in terms of more general parsing mechanisms.

(6) a. ... who _____ ...



b. ... who V-Q ...



Even in the study on Japanese *wh*-question scope (Aoshima et al. 2004) where there is no gap position, they found the evidence on the active filler parsing strategy. In Japanese, the *wh*-phrase should be associated with the question particle for its scope as in (b). According to Aoshima et al. (2004), when a declarative marker appeared instead of a question marker on the verb that the parser first met, the slower reading times were observed. It shows that the parser actively predicts Q particles as a sentence unfolds, rather than waiting to identify a Q particle.

(7) Subject-honorific ... Verb-honorific



If Korean honorific agreements use the active search parsing strategy¹, as soon as the honorifics are identified, the parser actively would predict the honorifics on the verb. It is expected that the slow-reading time will be observed when no honorific affix appears on the verb.

3. Experiment

Even though the Korean honorific agreement is not mandatory, Kwon & Sturt (2016) reported that the attraction effect was found in grammatical conditions, as well as ungrammatical

¹ Since sentences for Japanese *wh*-scope do not contain fillers and gaps, the term “active-filler” does not sound inclusive enough. Hence, we use the term “active search” instead of “active-filler.”

conditions. The simplified configuration for the illusion condition in (Kwon & Sturt 2016) is in (8). They observed that the processing difficulty of mismatching features in the subject-verb honorific agreement in the embedded clause was reduced when there was a structurally illicit, but feature matching main subject. This finding was accounted for by the active search parsing. Even though they conclude that during the dependency resolution of honorific markers, any potential target item in memory would be activated if it has a feature that matches the retrieval cue, there is still a possibility that the attraction effect on grammatical conditions may be caused by the different processing strategies. For example, Korean honorific agreements may involve different processing strategies such as “active search” strategy.

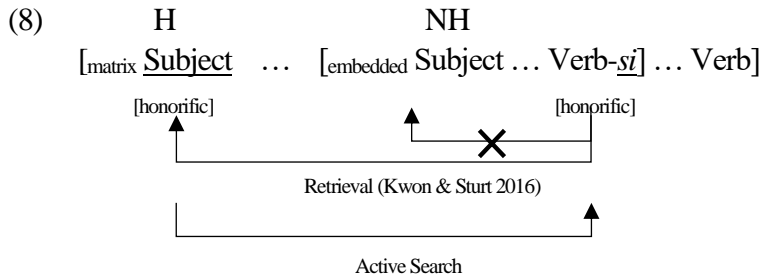

As soon as the honorable noun (the matrix subject in (8)) is encountered, the parser would actively seek the honorific affix *-si*, the partial feature matching (honorific feature match, but syntactic feature mismatch) might have led to the reduced processing difficulty. In order to test this hypothesis, we conducted a self-paced reading experiment.

3.1 Stimuli

Our stimuli consisted of a main clause and an embedded adjunct clause as in (8). In our experiment, the main clause subject and the embedded clause subject varied in their honorific features (H: Honorific, N: Not-honorific). Across all conditions, the embedded verb did not include the honorific affix *-si*, but the matrix verb did. Since the honorific affix *-si* appears on the matrix verb, the non-honorific matrix subject conditions (9c) and (9d) are ungrammatical.

| | | | | | | | |
|-----|------------------------------------|---|-----------------------------|--|---------------------------------|---|---|
| (9) | H | / | N | | H | / | N |
| | <i>{cwuim-nim-i / Cayhwuni-ka}</i> | | <i>ppalli</i> | | <i>[{paksa-nim-i /Minho-ka}</i> | | |
| | chief-HON-NOM / Cayhwuni-NOM | | quickly | | doctor-HON-NOM /Minho-NOM | | |
| | <i>sanghwangul</i> | | <i>phaakha-key]</i> | | <i>motun</i> | | |
| | situation-ACC | | Figure out-C | | all | | |
| | <i>pokose-lul</i> | | <i>nemkyecwu-si-ess-ta.</i> | | | | |
| | document-ACC | | Hand over-HON-PAST-DEC | | | | |

- a. HH: ‘The chief handed over all documents to him so that the doctor could figure out the situation quickly.’
- b. HN: ‘The chief handed over all documents to him so that Minhø could figure out the situation quickly.’
- c. NH: ‘Cayhwun handed over all documents to him so that the doctor could figure out the situation quickly.’
- d. NN: ‘Cayhwun handed over all documents to him so that Minhø could figure out the situation quickly.’

Sixteen sets of experimental sentences (64 sentences = 16 sets x 4 conditions) were created. They were distributed with fillers across 4 groups in a Latin Square design.

3.2 Participant

Fifty native speakers of Korean participated in the experiment. They were naive about the purpose of the experiment. Participants received \$5 for participation in the experiment. The experiment took 20-30 minutes.

3.3 Procedure

We conducted a self-paced reading experiment on the web-based platform PCIBex Farm. Stimulus presentation was word by word, self-paced, and non-cumulative. In order to make participants familiar with the self-paced moving window, we included the practice session. After the practice session, when participants were ready for the experiment, they pressed a button, and the experiment sentences were presented on the screen. The sentences were masked with dashes and the participants pressed the button (Space Bar) to see the next words. In the experiment, the presentation of each sentence was followed by a comprehension task. Comprehension questions asked about the content of the target sentences. For example, for the sentences in (9), “Who handed over all documents to Minho /the doctor?” was asked. For half of the sets, comprehension questions asked about the content of the main clause. For the other half of the sets, the content of the embedded clause was asked.

3.4 Prediction

In Korean, honorific feature matching happens within the same clause boundary. Since personal names (e.g., Cayhwun) are not paired with honorifics in Korean, the presence of an honorific marker *-si-* on the main verb induces ungrammaticality. The critical word positions are the embedded verb (region 5), which was always marked with the absence of the honorific marker *-si-*. The matrix verb (region 8), on the other hand was always marked with the presence of the honorific marker *-si-*.

Table 1. Predictions

| | Predictions (> : faster) |
|-----------------------------|---------------------------------------------|
| a. Retrieval Processing | NH > NN on region 8 (matrix verb) |
| b. Active Search Processing | NN > HH, NH, HN on region 5 (embedded verb) |

Analogous to the active-search strategy, if a parser actively seeks the honorific marker *-si-* for the dependency resolution after encountering honorific noun phrases (as in conditions), we expect the significant slow-down in the reading times of the embedded verbs. On the other hand, if Korean honorific agreement is one example of retrieval processing, the attraction effect would be observed (Kwon & Sturt 2016); the reading time of the condition (NH) on region 8 would be faster compared to the condition (NN) due to the erroneous temporal resolution of honorific dependencies (the honorific feature on the embedded subject- the honorific feature on the matrix verb).

4. Results & Discussion

4.1 Results

First, comprehension accuracy is given in Figure 1 (N = 50). Figure 1 shows that the overall accuracy is over 90%.

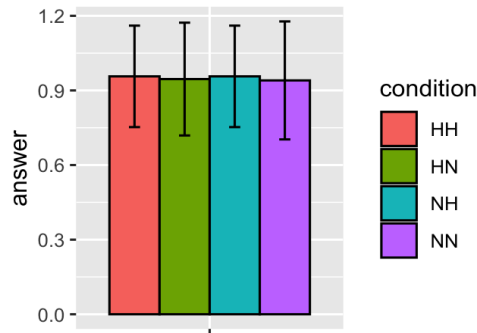

Figure 1. Overall accuracy by condition

The average word-by-word reading times for sentences are in Figure 2 and Table 2. The results in Figure 2 show that at the region 5 (the critical embedded verb position), there was a main effect of the embedded subject with the H-main conditions (HH:594 ms, NH: 582 ms) eliciting longer reading times than its N-main counterpart (HN: 538 ms, NN: 528 ms) (linear mixed effect model $p < .05$ in the following comparisons: HH-HN, HH-NN, NH-HN, NH-NN).

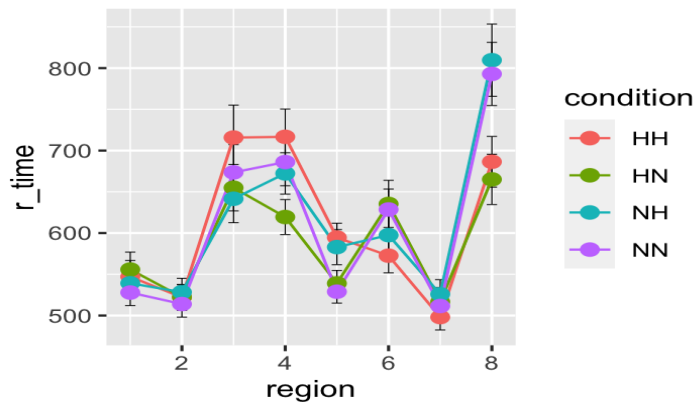

Figure 2. Word-by-word average reading times by conditions

Table 2 Average reading times on the region 5

| Matrix-Subject | Embedded-Subject | R5: Embedded Verb |
|----------------|------------------|-------------------|
| H | H | 594 ms |
| N | H | 582 ms |
| H | N | 538 ms |
| N | N | 528 ms |

Linear mixed model:
 $p < .05$

4.2 Discussion

Since the embedded verbs do not carry honorific features, there is no item that triggers the retrieval process for the honorific agreement. Thus, the slowdown of H-main conditions at region 5 cannot be accounted for by the retrieval processing strategy. Instead, the results suggest that Korean honorific agreements may involve different processing strategies, such as “active search” strategy similar to other long-distance dependencies in Korean (i.e. wh-Q dependency). It seems that Korean speakers tend to strongly predict an honorific marker for the honorific dependency resolution in the upcoming sentence after encountering an honorific noun, even though Korean honorific agreements are not obligatory. It seems that Korean honorific agreement resolution robustly obeys the syntactic constraint (clause-mate condition); in HN condition, the honorific noun did not affect the reading time on region 5. Considering the reading times on region 8, it also confirms the possibility that Korean speakers use the active filler strategy for the honorific dependency resolution. In region 8, the matrix verbs always included the honorific marker *-si-*, so the conditions of the not-honorific main subjects were ungrammatical. If the honorific marker *-si-* on the main verb is assumed to trigger retrieval processes, there should be the attraction effect.

Table 3 Average reading times on the region 8

| Matrix-Subject | Embedded-Subject | R8: Matrix Verb with <i>-si</i> |
|----------------|------------------|---------------------------------|
| N | H | 809 ms |
| N | H | 792 ms |

} Linear mixed model:
 $p > .05$

However, we could not find a significant reading time difference between NH (potential illusion) and NN (ungrammatical) condition.

5. Conclusion

This study investigated the processing of subject-verb honorific agreements in Korean. Contrary to Kwon & Sturt (2016), the attraction effect was not found. The overall results suggest that Korean subject-verb honorific agreements may involve the processing strategy similar to the “active filler” model.

References

- Aoshima, Sachiko, Colin Phillips, and Amy Weinberg. 2004. Processing filler-gap dependencies in a head-final language. *Journal of memory and language* 51(1), 23-54.
- Brown, Lucien. 2015. Honorifics and Politeness. In *The handbook of Korean linguistics*, ed. By L. Brown & J. Yeon, 303-319. Oxford: Wiley.
- Frazier, Lyn, and Charles Clifton Jr.. 1989. Successive cyclicity in the grammar and the parser. *Language and Cognitive Processes*, 4, 93-126.
- Kwon, Nayoung, and Patrick Sturt. 2016. Attraction effects in honorific agreement in Korean. *Frontiers in Psychology* 7, 1302–1316.
- Lago, Sol, Diego E. Shalom, Mariano Sigman, Ellen F. Lau, and Colin Phillips. 2015. Agreement attraction in Spanish comprehension. *Journal of Memory and Language* 82, 133–149.
- Pearlmutter, Neal J., Susan M. Garnsey, and Kathryn Bock. 1999. Agreement processes in sentence comprehension. *Journal of Memory and Language* 41(3), 427–456.
- Sohn, Ho-Min. 1999. *The Korean language*. Cambridge University Press.
- Wagers, Matthew W., Ellen F. Lau, and Colin Phillips. 2009. Agreement attraction in comprehension: Representations and processes. *Journal of Memory and Language* 61(2), 206–237.

Argument Ellipsis as Topic-Marking and A'-movement in Japanese*

Masako Maeda

Kyushu University

1. Introduction

This paper explores the ban on Argument Ellipsis (AE) of *wh*-phrases and focus phrases in Japanese (Sugisaki 2012, Ikawa 2013, Oku 2016, Saito 2017a). For instance, Sugisaki (2012) observes that when preceded by (1a), (1b) can only be interpreted as a Yes/No question, and does not permit an interpretation as a *wh*-question. This indicates that *wh*-phrases cannot be elided by AE. The example (2) shows that an element that is attached by the focus particle *sika* ‘only’ cannot undergo AE.

- (1) a. Speaker A. John-wa nani-o tabeta no?
 John-TOP what-ACC ate Q
 ‘What did John eat?’
 Speaker B. Ringo.
 apple
 ‘An apple.’
- b. Speaker A. Dewa, Mary-wa Δ tabeta no? (Yes/No question/**wh*-question)
 then Mary-TOP ate Q
 ‘Then, did Mary eat something/that?’
 *‘Then, what did Mary eat?’ (Sugisaki 2012: 64)

- (2) *John-wa zibun-no hon-sika kari-na-katta ga, Mary-wa Δ kawa-na-katta.
 John-TOP self-GEN book-SIKA borrow-NEG-PAST but Mary-TOP buy-NEG-PAST
 ‘*(Intended) John borrowed only his book, but Mary bought only her book.’
 (* Δ = *zibun-no hon-sika*) (Ikawa 2013)

In this paper, I follow Johnson (2001) in assuming that an elided argument is endowed with a topic feature and undergoes topicalization. I also assume that an element cannot satisfy contradictory criteria at the same time. These assumptions account for the ban on AE of *wh*-phrases and focus phrases, as the elided element cannot satisfy Topic Criterion and Wh/Focus criterion at the same time. It is also expected that an elided element can undergo QR, as QR does not satisfy any criterion at the landing site. Furthermore, it is expected that a topicalized

* The earlier version of this paper was presented at the seminar of the JSPS Core-to-Core Program, A. Advanced Research Networks “International Research Network for the Human Language Faculty” (#JPJSCCAJ221702004) (June 25, 2022). I am grateful to the audience at the seminar and at GLOW in Asia XIII, especially to Daeho Chung, Yuan Jian, Shigeru Miyagawa, Yoichi Miyamoto, Teruyuki Mizuno, Masao Ochi, Hiromune Oda, Shuki Otani and Satoshi Tomioka for their insightful comments and questions. Needless to say, all remaining errors are my own. This research is supported by JSPS KAKENHI Grant Numbers 18K12412, 21K00586 (PI: Nobuaki Nishioka) given to Masako Maeda, 18K00574 given to Yoichi Miyamoto, and the JSPS Core-to-Core Program, A. Advanced Research Networks “International Research Network for the Human Language Faculty” (#JPJSCCAJ221702004) given to Yoichi Miyamoto.

element may undergo AE, as topic criteria do not contradict with each other. The paper is organized as follows. Section 2 summarizes Saito’s (2017) and Oku’s (2016) analyses on the ban on AE of *wh*-phrases. Section 3 offers the proposal that AE is conducted by way of topicalization. Section 4 summarizes the analysis.

2. The Ban on Argument Ellipsis of *Wh*-phrases (Saito 2017a, Oku 2016, 2021)

2.1. Saito (2017a)

Building on the LF-copy analysis (Oku 1998), Saito (2017a) argues that when an element undergoes A'-movement and creates an operator-variable chain, neither the operator nor the variable can be successfully copied into the elided part. This leads to the ban on AE of a *wh*-phrase, as shown in (3).

- (3) A. [CP [TP Dare-ga Haiderabaad-e itta] ka] sitte imasu ka.
 who-NOM Hyderabad-to went Q know Q
 ‘Do you know who went to Hyderabad?’
- B. Iie. *Demo [CP [TP Δ Siena-e itta] ka] nara sitte imasu. (* Δ = who)
 no but Siena-to went Q if know
 ‘(Intended) No. But I know the answer if the question is who went to Siena.’
- (Saito 2017a: 723)

Saito assumes that *wh*-phrases in Japanese are operators and undergo covert movement to CP, where a *wh*-phrase is interpreted at two positions: an operator position and a variable position, as shown in (4). Saito then assumes that LF-copying can insert phrases only in argument positions. Given these, Saito argues that LF-copying of either an operator or a variable results in ungrammaticality. On the one hand, an operator, which is supposed to bind a variable in an argument position, cannot be copied to an argument position, as shown in (5a). On the other hand, the variable *x* cannot be copied into the argument position, because the configuration lacks the operator that binds the variable, as shown in (5b). Thus, LF-copying fails to produce a legitimate structure when the antecedent of ellipsis creates an operator-variable chain.

- (4) [for which *x*: *x* a person] *x* went to Hyderabad (Saito 2017a: 728)

- (5) a. *[for which *x*: *x* a person] went to Hyderabad
 b. **x* went to Hyderabad (Saito 2017a: 728)

Oku (2016, 2021), however, observes that a quantifier that undergoes Quantifier Raising (QR), which creates an operator-variable chain, can be elided by AE (see also Takahashi 2008). Therefore, Oku argues that the ban on AE cannot simply be attributed to the presence of an operator-variable chain, and offers an analysis based on the incompatibility between ellipsis and focus.

2.2. Oku (2016, 2021)

Oku (2008) observes that although Japanese is a “scope-rigid” language, there are cases where inverse scope interpretations are not only easily obtainable, but rather strongly favored. In sentences like (6), the surface scope is pragmatically odd and inverse scope is pragmatically

natural. In such cases, the inverse scope reading by QR is strongly preferred (see also Goro 2007).

- (6) TA-ga hitori dono CALL kyoositu-ni-mo taiki-simasu.
 TA-NOM one every CALL room-at-also wait.and.watch
 'A TA waits and watches in every CALL room.' (#one>every, every>one)
 (Oku 2016: 66)

Oku further observes that an element that undergoes QR can be elided, as shown in (7b).

- (7) a. Gozentyuu-wa TA-ga hitori dono CALL kyoositu-ni-mo taiki-simasu.
 morning-TOP TA-NOM one every CALL room-at-also wait.and.watch
 'In the morning, a TA waits and watches in every CALL room.'
 b. Gogo-wa RA-ga hitori Δ taiki-simasu. (Δ = every CALL room)
 afternoon-TOP RA-NOM one wait.and.watch
 '(Lit.) In the afternoon, an RA waits and watches Δ.' (#one>every, every>one)
 (Oku 2016: 66)

Oku argues that although a chain cannot be copied into an elided part (Saito 2017a), there is another possible derivational path; namely, an antecedent is copied before the operator-variable chain formation, as illustrated in (8b). Then, QR applies in a parallel fashion in both clauses as shown in (8c, d).

- (8) antecedent clause ellipsis clause
 a. [VP QP V] V
 b. [VP QP V] [VP QP V]
 ———— LF copy ————— ↑
 c. NP_{subj} [VP QP V] NP_{subj} [VP QP V]
 d. QP [NP_{subj} [VP t_{QP} V]] QP [NP_{subj} [VP t_{QP} V]]
 ↑ QR ↑ QR
- (Oku 2016: 67)

Regarding the ungrammaticality of AE of a *wh*-/focus phrase, Oku (2016) argues that as ellipsis presupposes de-focalization, an intrinsically focused element such as a *wh*-phrase and a focus phrase cannot undergo AE.

However, not all focus elements resist AE. Let us consider the example (9), where the object attached by DP-internal *dake* 'only' shows scope ambiguity with respect to the potential suffix, while the object with DP-external *dake* always takes a wide scope (Shoji 1986, Futagi 2004, Funakoshi 2011). Funakoshi (2011) argues that when *dake* precedes Case/postposition, focus movement is optional, leading to scope ambiguity, while when *dake* follows Case/postposition, focus movement is obligatory, yielding the obligatory wide scope of the object with respect to the potential suffix.

- (9) a. John-wa Mary-dake-to asob-e-ru. (only>can, can>only)
 John-TOP Mary-only-with play-POT-PRES
 ‘John can play with only Mary.’
 (i) *only>can*: the only person who John can play with is Mary (he cannot play with others)
 (ii) *can>only*: John can play with Mary alone (without playing with others)
 b. John-wa Mary-to-dake asob-e-ru. (only>can, *can>only)
 John-TOP Mary-with-only play-POT-PRES (Futagi 2004: 44-45)

Furthermore, Futagi (2004) and Funakoshi (2011) observe that an element with the focus particle *dake* can be elided when the focus particle precedes the Case marker, as shown in (10). In contrast, an element with DP-external *dake*, which undergoes obligatory focus movement, cannot undergo AE, as shown in (11). The contrasts in (10)-(11) indicate that AE can be applied to focus elements, but AE is not applicable to elements that undergo obligatory focus movement.

- (10) a. John-wa Mary-dake-to asob-e-ru.
 John-TOP Mary-only-with play-CAN-PRES
 ‘John can play only with Mary.’
 b. Bill-mo Δ asob-e-ru.
 Bill-also play-CAN-PRES
 ‘Bill also can play only with Mary.’ (Futagi 2004: 44-45)

- (11) a. John-wa Mary -to-dake asob-e-ru.
 John-TOP Mary-with-only play-CAN-PRES
 ‘John can play only with Mary.’
 b. *Bill-mo Δ asob-e-ru.
 Bill-also play-CAN-PRES
 ‘Bill also can play only with Mary.’ (Futagi 2004: 44-45)

The assumption that a *wh*-phrase is intrinsically focused also needs a close scrutiny. The Hichiku dialect of Japanese (including the Nagasaki dialect of Japanese: NJ and the Kumamoto dialect of Japanese: KJ) allows *ga/no* alternation on the subject, as illustrated in (12a). It is also observed that *-no* cannot follow a topic/focus phrase, as shown in (12b) (the anti-topic/focus property) (Kato 2007, Nishioka 2018, 2019). Still, *-no* can follow a *wh*-phrase, as shown in (13)-(14). This may contradict the assumption that a *wh*-phrase is intrinsically focused.

- (12) a. Hon-ba Maki-ga/no yon-da. (NJ)
 book-ACC Maki-NOM/NOM read-PAST
 ‘Maki read the book.’
 b. *Taroo-no iintyoo (desu) tai. (*exhaustive listing focus) (KJ)
 Taroo-NOM chair COP PART
 ‘Taroo is the chair.’ (Nishioka 2019: 31)

- (13) a. ... yonaka-ni natte nan-no detekuru ka siren. (NJ)
 midnight-at fall what-NOM come Q know.not
 ‘We don’t know what will come out when the night falls.’
 (Inoue Mitsuharu (1982), *Ashita*)
- b. Dai-ga/no ki-ta to?
 who-NOM/NOM come-PAST PART
 ‘Who came?’
- c. Hon-ba dai-ga/no yon-da to? (NJ)
 book-ACC who-NOM/NOM read-PAST PART
 ‘Who read the book?’
- (14) Kono hon-ba dai-no yomi-mo se-n-yatta. (NJ)
 this book-ACC who-NOM read-also do-NEG-PAST
 ‘Nobody read this book.’

These data support Saito’s (2017) analysis that it is only after covert *wh*-movement that *wh*-indefinite phrases specify their quantificational force; a *wh*-phrase in the *vP*-internal argument position, which is yet to have its *A'*-properties, can be marked with *no*-nominative Case without violating the anti-topic/focus condition.¹

Therefore, I assume that it is *wh*/focus-movement *per se* that is incompatible with AE. I propose a topicalization analysis for ellipsis (Johnson 2001, Maeda 2018, Fujiwara 2020, 2022, Mizuno 2021a, b, 2022), and argue that an elided element that undergoes topicalization cannot satisfy contradictory criteria at the landing site.

3. Proposal

Based on the fact that syntactic constituents which undergo VP topicalization are parallel to those which undergo VP-Ellipsis, Johnson (2001) argues that VP first undergoes syntactic topicalization in order to undergo ellipsis (see also Aelbrecht and Haegeman (2012) and Funakoshi (2012)).

- (15) a. Mary claims that [eat vegetables]_i, Holly won’t *t_i*.
 b. *Mary claims that [won’t eat vegetables]_i, Holly *t_i*.
 c. Fred won’t eat vegetables, and Holly won’t [~~eat vegetables~~].
 d. *Fred won’t eat vegetables, and Holly [~~won’t eat vegetables~~]. (Johnson 2001)

- (16) Deletion as topicalization (Johnson 2001)
 For an element to elide, it must first topicalize.

A close relationship between ellipsis and topicalization is ensured by the fact that elided elements are discourse-given or presupposed (Johnson 2001), which is assumed to be a core property of a topic (Erteschik-Shir 2007).

Fujiwara (2020, 2022) extends the movement and deletion analysis to AE in Japanese. Fujiwara argues that AE occurs in a way that elided elements must move to the matrix Spec, CP (see also Mizuno (2021a, b, 2022)). Fujiwara observes several pieces of evidence that show

¹ I assume that *wh*-movement can strand the Case particle (Oku 2021), so that the *wh*-phrase at the landing site may satisfy Wh Criterion without violating the anti-topic/focus property of *no*-nominative Case.

the parallelism between movement and ellipsis. For instance, he observes that the inner subject of the multiple subject construction (17) cannot move across the first subject, as shown in (18). He further shows that the inner subject cannot undergo AE, as shown in (19).

(17) *multiple subject construction*

John_i-wa okusan_j-ga zibun_{i/j}-no heya-de nemutte iru.
 John-TOP wife-NOM self-GEN room-in sleep be
 ‘As for John_i, his wife_j is sleeping in self_{i/j}’s room.’ (Fujiwara 2020)

(18) *the inner subject cannot move across the first subject*

*Okusan_j-ga/wa, Mary-wa [John_i-ga *t* zibun_{i/j}-no heya-de
 wife-NOM/TOP Mary-TOP John-NOM self-GEN room-in
 nemutte iru to] omotta.
 sleep be C thought
 ‘(Lit.) His wife, Mary thought [that as for John, *t* is sleeping in self’s room].’
 (Fujiwara 2020)

(19) *the inner subject cannot undergo AE*

- a. John_i-wa zibun_i-no okusan-ga heya-de nemutte iru.
 John-TOP self-GEN wife-NOM room-in sleep be
 ‘As for John_i, his_i wife is sleeping in her room.’
- b. Billi-wa Δ heya-de nemutte i-nai. (*sloppy reading)
 Bill-TOP room-in sleep be-NEG
 ‘Bill is not sleeping in his room.’
- *‘As for Bill_j, his_j wife is not sleeping in her room.’ (Fujiwara 2020)

Following the topicalization analysis for ellipsis, I propose that an elided element that undergoes topicalization cannot satisfy a criterion that conflicts with a topic feature. That is, the elided argument cannot undergo wh/focus movement and satisfies Wh/Focus Criterion, as the topic feature of the elided argument and a wh/focus feature contradicts.

(20) *Proposal*

- a. An elided element is licensed by undergoing topicalization to CP.
 b. An element cannot satisfy contradictory criteria at the same time.

The assumption behind (20b) is that an element can satisfy two criteria only if these criteria do not contradict. For instance, (21) shows that an element can satisfy Wh Criterion and Focus Criterion at the same time.

(21) *A wh-phrase in an embedded question can be contrastively focused*

Mi domandavo quale RAGAZZA avessero scieto, non quale ragazzo.
 I wondered which GIRL they had chosen not which boy
 (Rizzi 2006: 113)

Given (20), it is expected that an element that undergoes topicalization for ellipsis cannot satisfy Wh/Focus Criterion, as a topic feature and a wh/focus feature contradict. It is also expected that an elided element can undergo QR, as QR does not satisfy any criterion at the

landing site. Furthermore, it is expected that a topicalized element may undergo AE, as topic criteria do not contradict with each other. In the following subsections, I examine these expectations.

3.1. *wh*-indefinite phrases

Saito (2017b) argues that *wh*-indefinite phrases are operators that need to specify their quantificational force by (covertly) moving to the specifier position of the question particle -*ka* or the focus particle -*mo*.

- (22) a. Taroo-wa [<dare-ga> [dare-ga sore-o tabeta] ka] sitteiru.
 Taroo-TOP who-NOM it-ACC ate Q know
 ‘Taroo knows who ate it.’
 b. [<dare-ga> [dare-ga kaita] hon]-mo omosiroi.
 who-NOM wrote book-also interesting
 ‘For every *x*, *x* a person, the book that *x* wrote is interesting.’

(Saito 2017a: 1, slightly modified)

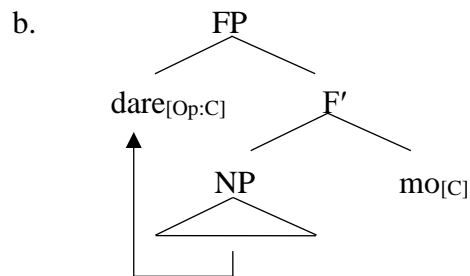
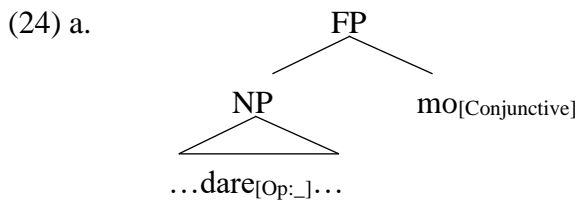
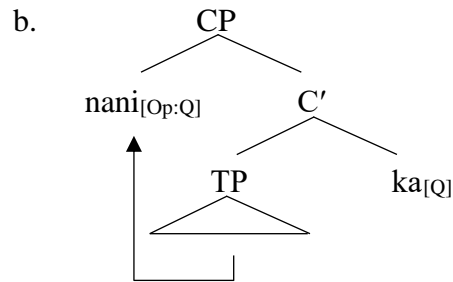
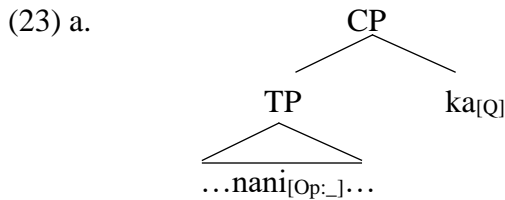

Under the covert *wh*-movement analysis, it is expected that an element that undergoes topicalization for ellipsis cannot satisfy Wh Criterion at the same time, as a topic feature and a *wh*-/focus feature contradict.

- (1) a. Speaker A. John-wa nani-o tabeta no?
 John-TOP what-ACC ate Q
 ‘What did John eat?’
 Speaker B. Ringo.
 apple
 ‘An apple.’
 b. Speaker A. Dewa, Mary-wa Δ tabeta no? (Yes/No question/**wh*-question)
 then Mary-TOP ate Q
 ‘Then, did Mary eat something/that?’
 *‘Then, what did Mary eat?’

(Sugisaki 2012: 64)

(25) *a wh-indeterminate phrase that is associated with -mo cannot be elided*

- a. John-wa [_{CP} Mary-ga nani-o homete-mo] yorokoba-na-katta.
 John-TOP Mary-NOM what-ACC praise-also happy-NEG-PAST
 ‘John was not happy no matter what Mary praised.’
- b. *Bill-wa [_{CP} Lucy-ga Δ homete-mo] yorokoba-na-katta. (* Δ = nani-o)
 Bill-TOP Lucy-NOM praise-also happy-NEG-PAST
 ‘*(Intended) Bill was not happy no matter what Lucy praised.’ (Ikawa 2013)

Saito (2021) further observes that there are *wh*-indeterminate phrases that are not associated with *ka/mo*, as shown in (26). Saito argues that such “bare” *wh*-phrases undergo focus movement to FocP in the CP periphery.

- (26) Hanako-wa [doko-ni iku to](-wa) itta ga, [itu iku to](-wa) iwa-na-katta.
 Hanako-TOP where-to go C-TOP said but when go C-TOP say-NEG-PAST
 ‘(Lit.) Hanako said where she is going, but she didn’t say when she is going there.’
 (Saito 2021)

In this regard, it is important to note that *wh*-indeterminate phrases with focus interpretation cannot undergo AE (Yoichi Miyamoto, p.c.).

- (27) a. *Maki-wa [dono hon-o kinoo yonda to]-wa itta ga,
 Maki-TOP which book-ACC yesterday read C-TOP said but
 [Δ kyoo yomu to]-wa iwa-na-katta. (* Δ = *dono hon-o* ‘which book’)
 today read C-TOP say-NEG-PAST
 ‘(Intended.) Maki said which book she read yesterday, but she didn’t say which book she would read today.’
- b. *Maki-wa [nani-o tabeta to]-wa itta ga,
 Maki-TOP what-ACC ate C-TOP said but
 [Δ nonda to]-wa iwa-na-katta. (* Δ = *nani-o* ‘what’)
 drank C-TOP say-NEG-PAST
 ‘(Intended.) Maki said what she ate, but she didn’t say what she drank.’

3.2. Focus phrases

In section 3.1, I show that *wh*-indeterminate phrases that undergo focus movement resist AE, as exemplified in (1), (25) and (27). In this section, I deal with other types of focus phrases: *dake* ‘only’ and *sika* ‘only’.

As observed in section 1, an element with the focus particle *dake* can be elided when the focus particle precedes the Case marker. In contrast, when the focus particle follows the Case marker, the element undergoes obligatory focus movement. The contrasts in (10)-(11) indicate that AE can be applied to focus elements, but AE is not applicable to elements that undergo obligatory focus movement. This is because an element that undergoes topicalization for ellipsis cannot satisfy Focus Criterion, as a topic feature and a focus feature contradict.

- (10) a. John-wa Mary-dake-to asob-e-ru.
 John-TOP Mary-only-with play-CAN-PRES
 ‘John can play only with Mary.’

- b. Bill-mo Δ asob-e-ru.
 Bill-also play-CAN-PRES
 ‘Bill also can play only with Mary.’ (Futagi 2004: 44-45)

- (11) a. John-wa Mary -to-dake asob-e-ru.
 John-TOP Mary-with-only play-CAN-PRES
 ‘John can play only with Mary.’

- b. *Bill-mo Δ asob-e-ru.
 Bill-also play-CAN-PRES
 ‘Bill also can play only with Mary.’ (Futagi 2004: 44-45)

Miyagawa *et al.* (2016) argue that an argument XP-*sika* ‘XP-only’ overtly moves to the focus position of the negative clause. As focus and topic contradict, XP-*sika* phrases cannot undergo AE, as shown in (28) and (29).

- (28) a. Yukito-wa Mika-ga ringo-sika tabe-na-katta to itta.
 Yukito-TOP Mika-NOM apple-SIKA eat-NEG-PAST C said
 ‘Yukito said that Mika ate only apple.’

- b. Haruki-wa Kaori-ga Δ tabe-na-katta to itta.
 Haruki-TOP Kaori-NOM eat-NEG-PAST C said
 (Lit.) ‘Haruki said Kaori didn’t eat.’ (* Δ = *ringo-sika*)

- (29) *John-wa zibun-no hon-sika kari-na-katta ga, Mary-wa Δ kawa-na-katta.
 John-TOP self-GEN book-SIKA borrow-NEG-PAST but Mary-TOP buy-NEG-PAST
 ‘*(Intended) John borrowed only his book, but Mary bought only her book.’
 (* Δ = *zibun-no hon-sika*) (Ikawa 2013)

3.3. QR

The present proposal accounts for Oku’s observation that an element that undergoes QR may be elided. AE in (8) and (30) is possible, as QR does not satisfy any criterion at the landing site and hence it does not induce any conflict with Topic Criterion.

- (8) a. Gozentyuu-wa TA-ga hitori dono CALL kyoositu-ni-mo taiki-simasu.
 morning-TOP TA-NOM one every CALL room-at-also wait.and.watch
 ‘In the morning, a TA waits and watches in every CALL room.’

- b. Gogo-wa RA-ga hitori Δ taiki-simasu.
 afternoon-TOP RA-NOM one wait.and.watch
 ‘(Lit.) In the afternoon, an RA waits and watches Δ .’ (#one>every, every>one)
 (Oku 2016: 66)

- (30) a. Taitei-no sensei-o zyosi-no dareka-ga sonkeisiteiru.
 most-GEN teacher-ACC girl-GEN someone-NOM respect
 ‘(Lit.) Most teachers, some girl respects.’

- b. Dansi-no dareka-mo Δ sonkeisiteiru. (some>most, most>some)
 boy-GEN someone-also respect
 ‘(Lit.) Some boy respects, too.’ (Takahashi 2008: 312)

3.4. Topic phrases

Although Kuno (1973) and Saito (1985) argue that in sentences like (31a), a topic-marked element is base-generated in the sentence-initial position, Ishii (2017) argues that the topic phrase is first merged with the nominative-marked element to constitute a small clause α , where the topic phrase acts as a predicate and the nominative-marked phrase acts as a subject, as shown in (31b). Then, the topic phrase undergoes topicalization to the sentence-initial position, as shown in (31c).

- (31) a. Sakana-wa tai-ga oisii.
 fish-TOP red.snapper-NOM delicious
 ‘As for fish, red snapper is delicious.’
 b. [α [_{nP1} sakana] [_{nP2} tai]] oisii
 c. [_{nP1} sakana]-wa [α t_{nP1} [_{nP2} tai]]-ga oisii (Ishii 2017: 127, 130)

Ishii’s proposal is supported, for example, by the fact that the topic phrase can be associated with the nominative phrase within the embedded clause, as shown in (32a), but it cannot be related with the one within the complex NP island, as shown in (32b).

- (32) a. Sakana-wa_i John-ga [[t_i tai-ga] oisii to] omotteiru.
 fish-TOP John-NOM red.snapper-NOM delicious C think
 ‘(Lit.) Speaking of fish, John thinks that red snapper is delicious.’
 b. ?*Sakana-wa_i John-ga [_{CNP} [[t_i tai-ga] oisii] mise]-o sitteiru.
 fish-TOP John-NOM red.snapper-NOM delicious restaurant-ACC know
 ‘(Lit.) Speaking of fish, John knows a restaurant where red snapper is delicious.’
 (Ishii 2017: 132-133)

Now, let us consider AE of a topic phrase. Taking (33a) as an antecedent sentence, (33b) is felicitous with the intended topic reading. This is because topicalization of an elided argument is permissible, as a topic feature for ellipsis does not conflict with another kind of a topic feature. Note that in (33c), the overt pronoun *it* does not have the topic meaning that (33a) and (33b) yield. The pronoun *it* in (33c) refers to the whole preceding sentence, yielding the meaning “if you are talking about the fish, and not as for fish”.

- (33) a. Sashimia-wa_i [t_i tai-ga] oisii.
 sashimi-TOP red.snapper-NOM delicious
 ‘(Lit.) Speaking of sashimi, red snapper is delicious.’
 b. Iya, Δ [t_i maguro-ga] oisii yo. (Δ = *sashimia-wa*)
 no, tuna-NOM delicious PART
 ‘(Lit.) No, speaking of sashimi, tuna is delicious.’
 c. #Iya, sore-wa maguro-ga oisii yo.
 no, it-TOP tuna-NOM delicious PART
 ‘(Lit.) No, speaking of it (= which sashimi is delicious), tuna is delicious.’
- (34) a. Hana-wa_i [t_i sakura-ga] ii.
 flower-TOP cherry.blossom-NOM good
 ‘(Lit.) Speaking of flowers, cherry blossom is good.’

- b. Un, Δ [t_i ume-mo] ii yo. (Δ = *hana-wa*)
 yes, plum.tree-also good PART
 ‘(Lit.) Yes, speaking of flowers, plum tree is also good.’
- c. #Un, sore-wa ume-mo ii yo.
 yes, it-TOP plum.tree-also good PART
 ‘(Lit.) Yes, speaking of it (= which tree is good), plum tree is also good.’

4. Conclusion and Implications

This paper proposes that an elided element undergoes topicalization and it may satisfy another kind of A'-feature only if the criterion in the moved position does not contradict the topic feature. Under the present analysis, an elided argument may undergo topicalization or QR, which does not contradict a topic feature, while the elided argument cannot undergo focus/wh-movement, as Wh/Focus Criterion is incompatible with a topic feature.

Although the present paper argues that (covert) A'-movement may contradict the requirement for AE, one might assume that it is (A'-) agreement *per se* that is incompatible with AE. In fact, Sugisaki (2012) and Ikawa (2013) propose the anti-agreement analysis for the ban on AE of *wh*-phrases.

- (1) a. Speaker A. John-wa nani-o tabeta no?
 John-TOP what-ACC ate Q
 ‘What did John eat?’
- Speaker B. Ringo.
 apple
 ‘An apple.’
- b. Speaker A. Dewa, Mary-wa Δ tabeta no? (Yes/No question/**wh*-question)
 then Mary-TOP ate Q
 ‘Then, did Mary eat something/that?’
 *‘Then, what did Mary eat?’ (Sugisaki 2012: 64)

Building on the LF-copy analysis (Oku 1998, Saito 2007), Sugisaki (2012) argues that an element that undergoes agreement is not eligible for ellipsis. For instance, when a *wh*-phrase that undergoes agreement with the interrogative C in the antecedent clause is copied to the ellipsis site, the copied element lacks an uninterpretable feature [uWh] that renders the element active for agreement in the elliptical clause. The derivation crashes due to the remaining uninterpretable feature [uQ] of the complementizer.

- (35) a. Overt Syntax of (1a, A)
 John-wa [DP nani-o_{iQ, uWh}] tabeta no_{uQ}?
 ↑ Agree ↓
- b. LF of (1a, A)
 John-wa [DP nani-o_{iQ, #Wh}] tabeta no_{#Q}?
 Copy ↓
- c. Overt Syntax of (1b)
 John-wa [DP nani-o_{iQ, #Wh}] tabeta no_{uQ}?
 ↑ *Agree ↓ (Sugisaki 2012: 70)

The present analysis and the anti-agreement analysis offer the same prediction with regard to the ban on AE of *wh*/focus phrases, as it may undergo A'-movement/in-situ agreement according to the analyses. However, these two lines of analyses present different predictions regarding in-situ agreement that do not require A'-movement; the movement analysis predicts that AE of an in-situ Agree element is possible, while the anti-agreement analysis predicts that it is not possible. Let us consider object honorification (OH) in Japanese, which requires in-situ Agree between the object and *v* (Harada 1976, Boeckx and Niinuma 2004, Boeckx 2006, Ikawa 2021, Ikawa and Yamada 2022, a.o.). It has been observed that OH targets either the direct object or the indirect object, but OH cannot target the direct object, skipping over the indirect object, as shown in (36).

- (36) a. Taroo-ga Tanaka-sensei-o o-tasuke-sita.
 Taroo-NOM Tanaka-teacher-ACC HON-help-did
 ‘Hanako helped Prof.Tanaka.’
- b. Hanako-ga Tanaka-sensei-ni Mary-o go-syookai-sita.
 Hanako-NOM Tanaka-teacher-DAT Mary-ACC HON-introduce-did
 ‘Hanako introduced Mary to Prof. Tanaka.’
- c. *Hanako-ga Mary-ni Tanaka-sensei-o go-syookai-sita.
 Hanako-NOM Mary-DAT Tanaka-teacher-ACC HON-introduce-did
 ‘Hanako introduced Prof.Tanaka to Mary.’ (Boeckx and Niinuma 2004: 456-457)

Boeckx and Niinuma (2004) argue that OH results from Agree between the object and *v*, and that the indirect object asymmetrically c-commands DO and hence IO shows the intervention effect between *v* and DO. In this light, it is important to note that the object that undergoes OH can be elided by AE. (37b), preceded by (37a), may yield the quantificational reading that is absent in (37c) with the overt pronoun. This indicates that (37b) can be derived from AE. The fact that AE of the element that undergoes in-situ Agree is possible supports the movement analysis.

- (37) a. Ken-wa san'nin-no sensei-o o-tasuke-sita.
 Ken-TOP three-GEN teacher-ACC HON-help-did
 ‘Ken helped three teachers.’
- b. Maki-mo Δ o-tasuke-sita. (E-type reading/quantificational reading)
 Maki-also HON-help-did
 ‘Maki also helped Δ.’ (Δ = the three teachers/three teachers).’
- c. Maki-mo karera-o o-tasuke-sita. (E-type reading/*quantificational reading)
 Maki-also them-ACC HON-help-did
 ‘Maki also helped them.’ (them = the three teachers/*three teachers).’

References

- Aelbrecht, Lobke and Liliane Haegeman. 2012. VP-ellipsis is not licensed by VP-topicalization. *Linguistic Inquiry* 43: 591-614.
- Boeckx, Cedric. 2006. Honorification as agreement. *Natural Language and Linguistic Theory* 24: 385-398.
- Boeckx, Cedric and Fumikazu Niinuma. 2004. Conditions on agreement in Japanese. *Natural Language and Linguistic Theory* 22: 453-480.
- Erteschik-Shir, Nomi. 2007. *Information Structure: The Syntax-Discourse Interface*, Oxford: Oxford University Press.
- Fujiwara, Yoshiki. 2020. Argument ellipsis involves movement. Ms., University of Connecticut.
- Fujiwara, Yoshiki. 2022. Movement approach to ellipsis, Ph.D. dissertation, University of Connecticut.
- Funakoshi, Kenshi. 2011. Object drop in Japanese: Evidence for the VP-ellipsis analysis. *The Project on Language and Culture 2010: Theoretical Approaches to Natural Language*: 61-70.
- Futagi, Yoko. 2004. Japanese focus particles at the syntax-semantics interface. Doctoral dissertation, The State University of New Jersey.
- Goro, Takuya. 2007. Language-specific constraints on scope interpretation in first language acquisition, Ph.D. dissertation, University of Maryland.
- Harada, Shin-Ichi. 1976. Honorifics. In *Syntax and Semantics 5*, ed. by Masayoshi Shibatani, 499-561, Academic Press, New York. [Republished 2000, *Syntax and Meaning: S.I. Harada Collected Works in Linguistics*, ed. by Naoki Fukui, 265-338, Taishukan, Tokyo.]
- Ikawa, Hajime. 2013. What the ineligibility of wh-phrases for argument ellipsis tells us: On the inertness of phonetically null elements,” *Online Proceedings of GLOW in Asia 2012*.
- Ikawa, Shiori. 2021. Interpreting agreement: Evidence from Japanese object honorifics. *Proceedings of Linguistic Society of America* 6 (1): 228-242.
- Ikawa, Shiori and Akitaka Yamada. 2022. A hybrid approach to honorific agreement. Ms. for the *Proceedings of Chicago Linguistic Society (CLS)* 56.
- Ishii, Toru. 2017. A movement analysis of Japanese “gapless” topicalization. *Proceedings of the 12th Workshop on Altaic Formal Linguistics (MITWPL 83)*, 127-138.
- Johnson, Kyle. 2001. What VP-ellipsis can do, and what it can’t, but not why. In *The Handbook of Contemporary Syntactic Theory*, ed. by Mark Baltin and Chris Collins, 439-479. Oxford: Blackwell.
- Kato, Sachiko. 2007. Scrambling and the EPP in Japanese: From the viewpoint of the Kumamoto Dialect in Japanese. *MIT Working Papers in Linguistics* 55, 113-124.
- Kuno, Susumu. 1973. *The structure of the Japanese language*. Cambridge, MA: MIT Press.
- Maeda, Masako. 2018. Ellipsis as topicalization in derivational cartographic structures, *English Linguistics* 34 (2): 331-347.
- Mizuno, Teruyuki. 2021a. Argument ellipsis and topicalization: A view from their interaction with wh-dependencies,” Paper presented at PLC 45.
- Mizuno, Teruyuki. 2021b. Argument ellipsis, topicality, and a theory of null anaphora. Paper presented at CLS 57.
- Mizuno, Teruyuki. 2022. Argument ellipsis as topic deletion, Ms., University of Connecticut (available at <https://lingbuzz.net/lingbuzz/006711>).
- Miyagawa, Shigeru, Nobuaki Nishioka and Hedde Zijlstra . 2016. Negative sensitive items and

- the discourse-configurational nature of Japanese. *Glossa* 1 (1): 33: 1-28.
- Nishioka, Nobuaki .2018. On the positions of nominative subject in Japanese: Evidence from Kumamoto Dialect,” *MIT Working Papers in Linguistics* 87, 165-177.
- Nishioka, Nobuaki. 2019. Discourse-configurationality and the scope of negation. *Nanzan Linguistics* 14: 25-55.
- Oku, Satoshi. 1998. *A theory of selection and reconstruction in the Minimalist Perspective*. Ph.D. dissertation, University of Connecticut.
- Oku, Satoshi. 2008. “Toogo, Zyoohoo Koozoo, Ippan Nintiryoku [Syntax, Information Structure, General Cognition].” In *Toogoron-no Sintenkai to Nihongo Kenkyuu: Meidai-o Koete* [A New Development of Syntax and Studies of the Japanese Language: Beyond Propositions], ed. by Nobuko Hasegawa, 227-267. Tokyo: Kaitakusha.
- Oku, Satoshi. 2016. A note on ellipsis-resistant constituents. *Nanzan Linguistics* 11: 57-70.
- Oku, Satoshi. 2021. Merge, selection, and ellipsis-resistant constituents. Paper presented at the 93rd Annual General Meeting of The English Literary Society of Japan, online.
- Rizzi, Luigi. 2006. On the form of chains: Criterial positions and ECP effects. In *Wh-movement: Moving on*, ed. by Lisa Cheng and Norbert Corver, 97-133. Cambridge, MA: MIT Press.
- Saito, Mamoru. 1985. Some asymmetries in Japanese and their theoretical consequences, Ph.D. dissertation, MIT.
- Saito, Mamoru..2004. “Ellipsis and Pronominal Reference in Japanese Clefts,” *Nanzan Linguistics* 1, 21-50.
- Saito, Mamoru. 2007. “Notes on East Asian Argument Ellipsis,” *Language Research* 43, 203-227.
- Saito, Mamoru..2017a. “Ellipsis,” *Handbook of Japanese Syntax*, ed. by Shigeru Miyagawa and Masayoshi Shibatani, 701-750. Berlin: Mouton de Gruyter.
- Saito, Mamoru. 2017b. Japanese wh-phrases as operators with unspecified quantificational force. *Language and Linguistics* 18: 1-25.
- Saito, Mamoru. 2021. Wh-phrases without quantificational particles. Talk at the seminar of JSPS Core-to-Core Program (A) International Research Network for the Human Language Faculty.
- Shoji, Atsuko. 1986. ‘Dake’ and ‘Sika’ in Japanese: Syntax, Semantics and Pragmatics, Ph.D. dissertation, Cornell University.
- Sugisaki, Koji. 2012. A constraint on argument ellipsis in child Japanese. *Nanzan Linguistics* 7: 63-76.
- Takahashi, Daiko. 2008. Quantificational null objects and argument ellipsis, *Linguistic Inquiry* 39: 307-326.

Deriving the clitic string by Sequence Formation

Maria Rita Manzini^{1,3}, Diego Pescarini^{2,3}

¹Università di Firenze, ²CNRS, ³Université Côte d'Azur

1. Introduction

Previous generative accounts of pronominal clitics take the explanandum to be the clitic unit X and focus on how to model the relationship between X and its alleged argument position via movement (Kayne 1991, Roberts 2010) or via Agree with an empty category *pro* (Sportiche 1996). In our approach, conversely, the explanandum is not the single clitic X and its link to an argument position, but the *clitic string* ...X..., a sequence of syntactic heads which displays at least the following properties:

- *incorporation*, i.e. clitics cannot undergo any derivation independently of the others in the string (and eventually of the verbal head);
- rigid internal order, yet *at variance with the dominance* order displayed by phrasal constituents, see Section 2;
- constrained distribution: the clitic string occurs only in certain specific positions that roughly correspond to *phase heads*.

To model clitic strings we contend that they cannot be built via Set Merge. Unlike XP arguments, clitic sequences are not sensitive to well-known dominance effects that are typical of Set Merged elements (see Section 2). We will show that the lack of dominance effects can be hardly accounted for within current movement or Agree analyses. Instead, in Sections 3-4 we argue for a novel approach resting upon the hypothesis that clitics are Pair Merged to a Link, forming a Sequence without internal hierarchical structure.

2. No dominance

The linearization of clitic pronouns is mostly independent from the structural and linear order of the corresponding XPs. For instance, French and Italian have opposite orders of third person clitics: Accusative > Dative in French, Dative > Accusative in Italian, see (1). However, accusative and dative XPs c-command one another in both French and Italian, see (2) and (3) respectively – in other words there is no difference between Italian and French phrasal syntax.

- (1) a. Jean **le lui** a rendu DO>IO Fr.
 Jean **it=to.him**=has given.back
 ‘Gianni gave it back to him’
- b. Gianni **glielo** ha reso IO>DO It.
 Gianni **to.him=it**=has given.back
 ‘Gianni gave it back to him’
- (2) a. La maîtresse a rendu [DP **son** cartable] [PP à **chaque** élève]
 the teacher has given-back **his** schoolbag to **each** pupil
 ‘The teacher gave each pupil his schoolbag back’
- b. La maîtresse a rendu [DP **chaque** cartable] [PP à **son** propriétaire]
 the teacher has given-back **each** schoolbag to **its** owner
 ‘The teacher gave each schoolbag back to its owner’ French (Boneh and Nash 2012)

- (3) a. La maestra rende la **sua** cartella a **ciascun** alunno
the teacher gives-back the his schoolbag to each student
‘The teacher gives each pupil his schoolbag back’
b. La maestra rende **ciascuna** cartella al **suo** proprietario
the teacher gives-back each schoolbag to its owner
‘The teacher gives each schoolbag back to its owner’
Italian (cf. also Giorgi and Longobardi 1991: 42-43)

The order of clitics remains unchanged if, instead of a selected dative (an Indirect Object), the clitic pronominalizes an unselected dative (a benefactive), as in (4), although we know that unselected dative PPs (‘high’ Appls) c-command selected dative PPs (‘low’ Appls), see (5) (see Folli and Harley 2006 for Italian; Italian data are not reported here because of space limitations):

- (4) a. Marie **le lui** a peint Fr.
Marie **it=to.him** has painted
‘Marie painted it for him.’
b. Gianni **gliela** dipinge It.
Gianni **to.him=it** paints
‘Gianni paints it for him.’

- (5) a. Marie a peint [DP **sa** maison] [PP à **chaque** locataire]
Mary has painted **his** house to **every** tenant
‘Mary painted his house for each tenant.’
b. *Marie a peint [DP **chaque** maison] [PP à **son** locataire]
Mary painted each house to its tenant
‘Mary painted each house to its tenant.’ (Boneh and Nash 2012)

How can we account for the lack of correspondence between the make-up of clitic sequences and the syntax of XP arguments? In the following subsections, we try to answer this question in the light of two well-established analyses of clitic dependencies.

2.1. Movement analysis

According to movement analyses (Kayne 1991), clitics are first merged in argument position and necessarily undergo a movement derivation, at the end of which they are read as heads on the functional spine of the sentence, as in (6) (cf. Chomsky 1995:28 for min/max categories).

- (6) a. Marie le voit Fr.
Marie him=sees
b. [IP D [IP I [VP V D^{min/max} clitic movement
 ↑_____]

Under (6), we expect clitics either to preserve the order of their base-generation positions (to avoid nesting dependencies) or to mirror the order of their base-generation positions (assuming traditional head movement/incorporation, or “snowball movement”). Neither prediction is borne out, witness the Italian and French examples above. This has led scholars to postulate

post-syntactic reordering within a DM(-type) morphological component. However, why would the morphological component work to opacize the underlying syntax (Manzini & Savoia 2007, Collins and Kayne 2020)? Elsewhere, the morphological externalization interface works to optimize legibility of the syntax, cf. Selkirk’s (1974) conclusion that phonosyntactic processes follow and highlight major constituents contours, D’Alessandro and Scheer (2015) for phasal Spell-Out.

Setting then aside morphological reordering, the fact remains that structural properties of phrasal syntax are not preserved in the clitic string (or mirrored by it). The latter is structurally constrained in ways that equivalent phrasal constituents are not and movement analyses cannot provide an adequate solution to this asymmetry.

2.2. *pro* analysis

A second stream of generative analyses (traditionally dubbed “base generation approaches”) assume that clitics are first merged as functional heads, namely as Voice (AccVoice etc.) according to Sportiche (1996), systematically agreeing with *pro*’s in argument position.

(7) ... [_{VP} V [_{AccVoice} D [_{VP} V [_{DP} *pro*]]]] clitic-*pro*

|_____|

In current minimalism, however, *pro* is controversial. If the EPP is eliminated at least for null subject languages (Chomsky 2015), *pro* is a pure means for the satisfaction of the Uniformity of Theta Assignment Hypothesis (UTAH) of Baker (1988) – itself a special case of Uniformity, namely the principle that “the same meaning always maps onto the same syntactic structure” (Culicover and Jackendoff 2005). In a nutshell, *pro* ensures that the clitic in (8b) is interpretively equivalent to some phrasal unit XP such as *Jean/lui* in (8a), by being first merged in the same theta configuration.

- (8) a. Marie voit Jean/lui Fr.
 Mary sees John/HIM
 b. Marie le voit
 Marie him=sees
 ‘Marie sees him

However, clitics can form idioms that have no full pronominal counterpart:

- (9) Gianni **ce l’** ha fatta (idiom) It.
 Gianni there=it has made
 ‘Gianni made it/succeeded’

A [_V *pro*] structure, whose idiomatic reading involves no theta relation between V and *pro*, denies the basic reason why *pro* would be merged (i.e. the UTAH). At least in idiomatic configurations, the Acc clitic can discharge its formal properties without any need for a *pro*, which therefore has no reason to be merged.

3. Our proposal

Our analysis aims to keep cliticization within core syntax (i.e. no recourse to morphological

readjustment), by rejecting Uniformity, namely the assumption that clitics have the same core syntax as phrasal arguments, hence a Set Merge syntax.

The implementation of our hypothesis depends on currently available theoretical tools including:

- a) a syntactic Merge mechanism different from Set Merge – namely Pair Merge (Chomsky 2004)
- b) the modelling of head syntax by Pair Merge (Epstein, Kitahara and Seely 2016, cf. Chomsky 2015)
- c) the notion of Pair Merge Sequence (Chomsky 2020) or of Form Sequence (Chomsky 2021a, To appear) to model clitic clusters.

Building on (a-c), we propose that the clitic cluster ...X... is a Pair Merge Sequence (Chomsky 2020), where each member of the sequence $\langle X, L \rangle$ is formed by a clitic head X and a Link L, L a phase head. Take for instance the example in (10a), from a northern Italo-Romance dialect. We suggest that the (en)clitic sequence *-gg-u* ‘it to him’ can be represented as in (10b), following Chomsky’s (2004) notation for Pair Merge and Chomsky’s (2020) notation for Pair Merge Sequences – assuming the phase head ν to be the Link.

- (10)a. al da **-gg** **-u**
 he gives=**to.him=it**
 ‘He give it to him’
- b. $[_{VP} \langle \langle gg, \nu \rangle, \langle u, \nu \rangle, \langle V, \nu \rangle \rangle] [_{VP} V]$

The simplified notations in (11) can be used instead of (10b). (11a) and (11b) show the general output of Sequence Formation (SF; Chomsky 2021a, b). Conventionally, the rightmost label is that of the Link.

- (11)a. $[\langle gg, u, V, \nu \rangle] [_{VP} V \dots]]$
 b. $[\langle Cl_2, Cl_1, V, \nu \rangle] [_{VP} V \dots]]$

Sequences such as (10b), (11) are derived through the following steps: first, the Link ν is Set Merged in the general tree as shown in (12a), cf. Chomsky (2004); then the Pair Merge couple $\langle V, \nu \rangle$ in (12b) models ν -V inheritance (like $\langle C, I \rangle$ inheritance for Chomsky 2020). The position of the Pair Merge unit in the Set Merge tree is understood to be the position of ν . In (12c) we proceed with the generation of the clitic sequence. Adjunction of the clitic Cl_1 , like other adjunctions, is modelled by external Pair Merge, yielding the Pair Merge couple $\langle Cl_1, \nu \rangle$. The merger of two elements, here Cl_1 and V to the same Link is assumed to generate a Pair Merge Sequence. Other clitics can be Pair Merged to the Link and added to the sequence as illustrated in (12d).

- (12)a. $[\nu [_{VP} V \dots]]$
 b. $[\langle V, \nu \rangle [_{VP} V \dots]]$
 c. $[\langle \langle Cl_1 \nu \rangle, \langle V, \nu \rangle \rangle [_{VP} V \dots]]$
 d. $[\langle \langle Cl_2, \nu \rangle, \langle Cl_1, \nu \rangle, \langle V, \nu \rangle \rangle] [_{VP} V \dots]]$

However, to pursue a Pair Merge/Sequence account of clitics, we must discard Uniformity. In

Manzini (2022), Manzini & Pescarini (in press), we argue that models pursuing convergence at SEM, instead of uniformity, fit better the data. Thus non-uniform syntactic structures (i.e. Set Merged hierarchies of XPs and Pair Merged Sequences of X^0) are mapped onto a single logical form that is expressed in neo-Davidsonian terms as a coordination of arguments (Parsons 1995, cf. Larson 2014), e.g. (13b) for English (13a):

- (13) a. He gives it to him
 b. $\exists e$ [*give*(*e*) & Agent(*e*, *he*) & Theme(*e*, *it*) & Goal(*e*, *him*)]

Since the ordinary interpretation of a Pair Merge Sequence is Conjunction (Chomsky 2020, 2021a, To appear), then Pair Merged clitic arguments in (14a) (= (10b) above) can have an analogous interpretation, as in (14b), that converges with the interpretation of Set Merged arguments in (13b).

- (14)a. [_{VP} <<*gg*, *v*>, <*u*, *v*>, <*da*, *v*>> [_{VP} *da*
 b. $\exists e$ [*da*(*e*) & Agent(*e*, *al*) & Theme(*e*, *u*) & Goal(*e*, *gg*)

Importantly, Pair Merge of clitics with a Link to form a Sequence, e.g. (14b), obeys Duality of Semantics (Chomsky 2021a, b), since External Merge (EM) is involved – though not Set Merge.

4. Some consequences

In this section, we argue that the contrast between phrasal and clitic behaviors is not to be imputed to core syntax vs. externalization (morphology) but to Set Merge (phrasal syntax) vs. Pair Merge (of heads). In particular, we argue that Pair Merge accounts by construction for basic properties of clitic sequences such as:

- Incorporation, see subsection 4.1;
- Internal ordering of sequences, see subsection 4.2;
- Placement of the string in the clause, see subsection 4.3.

4.1. Incorporation

Only the entire sequence of clitics as is a syntactic object accessible to movement. For instance, in (15) the clitic string in brackets is moved above the question C-particle *li* (Bošković 2004); no clitic can remain stranded below *li*.

- (15) [Ne si mu gi dal]_i li t_i parite? (Macedonian)
 NEG= are= him.DAT= them.ACC given PART money-the
 ‘Haven’t you given him the money?’

A displacement of this kind is at odds with Set Merge syntax; specifically, recall that for Sportiche (1996), Clitic Voices are individually Set Merged. The only option open is to postulate incorporation of the clitics to each other via extra-syntactic operations such as merger (Matushansky 2006) – or to revert to movement. Movement approaches are better equipped to deal with incorporation (via canonical head adjunction), but it remains unclear why multiple clitic heads end up being adjoined to the same head (though see Roberts 2010). In Kaynian systems where head movement does not need (featural) justification, incorporation is constrained: for Kayne (1994) at most two clitics can be adjoined to one another.

Pair Merge Sequences, on the contrary, account for *incorporation* by construction. We do not need any ad hoc mechanism to map structures generated via Set Merge into sequences. At the same time, consider that Pair Merge is not introduced to account for clitics alone, but it is a tool that has been introduced in the theory for independent reasons – i.e. to model adjunction and unbounded coordination. We therefore believe that, by extending Pair Merge/Sequences to the analysis of clitics, we achieve a descriptive gain at no extra theoretical cost.

4.2. Order

As previously mentioned, the order of clitic pronouns cannot be predicted from the order of XP arguments. Whereas dominance is the main criterion for the linearization of XPs, languages seem to follow other criteria in linearizing pronominal clitics. For instance, in Pashto (Tegey 1975) pronominal clitics are linearized according to person. Singular pronouns follow the order $1 > 2 > 3$ *regardless* of their role (subject, object, possessor).

- (16)a. topak **me de** raworə. (Pashto; Tegey 1975)
 gun 1SG 2SG brought
 ‘I brought your gun / You brought my gun.’
- b. topak **me y** raworə.
 gun 1SG 3SG brought
 ‘I brought his gun / He brought my gun.’
- c. topak **de y** raworə.
 gun 2SG 3SG brought
 ‘You brought his gun / He brought your gun.’

In Tagalog, monosyllabic pronouns (*ko* ‘me’, *ka* ‘you.S’, *mo* ‘you.O’) precede disyllabic pronouns, regardless of person or case (Schachter & Otanes 1972: 185 quoted by Billings & Konopasky 2020):

- (17)a. Nakita **ko siya**. (Tagalog; Billings & Konopasky 2020)
 be.seen 1SG.O 3SG.S
 ‘I saw him/her.’
- b. Nakita **mo ako**.
 be.seen 2SG.O 1SG.S
 ‘You (Sg.) saw me.’

The Romance languages follow a mixed system in which Person and Case seem to play a role in sequencing clitics, and the output diverges across languages, as shown in Section 2.

Given the evidence in Section 2 and in exx. (16)-(17), we conclude that the better theory of clitic is the one that makes no strong prediction on the linearization of clitics based on the order of the corresponding phrasal arguments. This does not amount to saying that the linearization of clitics is free or unconstrained. In fact, clitic pronouns are normally rigidly ordered, but, crucially, they are ordered (on a language-specific basis) independently of phrasal arguments (e.g. by the Person hierarchy in Pashto (16), but also in French, where *le lui* ‘it to him’ in (1) contrasts with *me le* ‘to me it’, i.e. $1/2P > 3$). Consequently, if the aim of the analysis is to keep cliticization within core syntax, the analysis should have no expectation regarding

the ordering of clitic elements based on phrasal syntax. In particular, it should not predict that the internal order of the clitic sequence reproduces/mirrors the (dominance) order of the phrasal arguments.

4.3. Placement

With the term *placement* we refer to the order of the clitic string in the sentence. In Italian and in French, clitics are externalized in the C-I phase (adjoined to I(P), Kayne 1991). In other languages however they are externalized in the ν phase, notably in certain Italo-Romance varieties like the one exemplified in (10) and in Bantu (Riedel 2009).

In our account, this property again follows by construction, provided we identify the possible Links of Pair Merge Sequences with phase heads ν , C, or I (via inheritance from C). If we turn our attention to less well-known languages, even within the Romance family, clear evidence for clitic placement in ν , C, I can be found in contexts of *interpolation*, i.e. in languages in which the verb and the clitic string can be separated, as shown in (18):

- (18)a. O livro que **lhe** ainda não entreguei (Portuguese dialect)
 The book that to.him= yet not handle
 ‘The book that I did not give him yet’
- b. Un **mi** cchù parra (Cosentino, South Italy)
 not me= any.more speaks
 ‘He does not speak to me any more.’

By focusing on languages allowing interpolation, we can better pinpoint the exact position where clitic strings are (Pair) merged – since we can gauge their position independently of the position of the verbal head. As predicted by our model, clitic sequences are found in association with all phasal heads: with C (old Spanish, old Portuguese, western Ibero-Romance dialects (18a); see Martins 1994ff.); with I (Italo-Romance varieties such as Cosentino (18b) and Triestino; see Ledgeway & Lombardi 2005); with ν (Eastern Piedmontese (10), see Tortora 2015) – see also Pescarini (2021) for an overview.

Furthermore, having multiple potential Links for clitic sequences, we can fine-tune clitic placement, which is not uniform across clausal environments. Languages with clitics and no interpolation still display partial independence of the verb and of the clitic string, which can either linearly recede or follow the Link, yielding, respectively, proclisis (clitic string ν) or enclisis (ν clitic string). In Romance, enclisis is triggered by several factors including polarity, tense, mood, finiteness, information structure, as illustrated in (19) for Italian.

- (19)a. **Me/ce lo** porta. Declarative, proclisis (It.)
 to.me/there it= he.brings
 ‘He brings it there/to me’
- b. Porta-**melo!**/ Porta-**ce-lo!** Imperative, enclisis
 Bring=me=it/ bring=there=it
 ‘Bring it there/to me!’
- c. Cerca di portare-**me-lo/-ce-lo.** Infinitive, enclisis
 Try to bring=to.me=it/there=it
 ‘Try to bring it to me/there.’

Kayne's (1991) analysis of enclisis/proclisis alternations views proclisis as the result of clitic movement to I, and enclisis as the result of moving the verb from I to C across the clitics in I. This analysis can be recast in our framework without losing descriptive adequacy, and avoiding in fact difficulties with basic tenets of the theory. For instance, verb movement from I to C across the clitic heads incurs a potential violation of the Head Movement Constraint (HMC), i.e. of Minimality; it further requires the clitics not to be incorporated to the verb, which goes against the grain of the impossibility of interpolation in Italian (or French).

To illustrate our point, in (20)-(22) we sketch a tentative analysis of a well-known puzzle: subject clitic inversion in French interrogatives. As shown in (20b), in questions subject clitics appear in enclisis, when object clitics are in proclisis:

- (20)a. **Il le lui** donne. (Fr.)
 he= it= to.him/her= give.3SG
 'He gives it to him/her.'
- b. **Le lui** donne-t-il?
 it= to.him/her= give.3SG-t-he
 'Does he give it to him/her?'

The evidence in (20b) shows that object (OCLs) and subject clitics (SCLs) do not belong to the same Pair Merge Sequence, otherwise they could not be broken apart. In particular, we suggest that in declarative clauses such as (20a), both OCLs and SCLs are Pair Merged with I as in (21):

- (21) [IP <<SCL, I>, <OCL, I>, <OCL, I>, <<donne, v>, I>>] [VP ..

When C has interrogative force, however, SCLs are not Pair Merged with I, but (externally) Pair Merged with C as shown in (22a). This formalizes the widely shared intuition in descriptive Romance linguistics that subject enclitics represent an 'interrogative inflection'. Then inversion of the verb (along with its Pair-Merged clitics), takes place as shown in (22b) via (internal) Pair Merge of the <OCL, I> sequence with C.

- (22)a. [CP <SCL, C_{INT}> [IP <OCL, I> [VP ...]]]
 b. [CP <<OCL, I>, C_{INT}> <SCL, C_{INT}>> [IP <<OCL, I> [VP ...]]]

5. Conclusions

In this paper we assessed whether a Pair Merge approach to Romance clitics is feasible and whether it holds any empirical advantage. Our conclusion is that key properties of clitic strings follows by construction if clitic, verb clusters are built as Pair Merged sequences. Such sequences are point-like from the point of view of phrasal syntax, explaining the incorporation property of clitic string, i.e. the fact that single clitics cannot undergo movement operations independently of the others. The lack of any necessary correspondence/mirroring of clitic order with respect to phrasal order in argumental structures is also expected. Slightly less familiar issues (interpolation, enclisis, inversion) receive a principled explanation under the assumption that clitics are Pair Merged with different phase heads – and only phase heads. In short, Pair Merge, which has been independently introduced to account for modification and conjunction, provides an optimal tool for representing clitics in syntactic structures. This innovation comes

at a price, namely in order to pursue a Pair Merge/Sequence account of clitics, we must give up Uniformity (specifically the UTAH) pursuing only the weaker requirement of convergence at SEM. External Pair Merge of clitics is in compliance with basic tenets of minimalism such as *Duality of Semantics*.-

=

References

- Baker, Mark. 1988. *Incorporation: A Theory of Grammatical Function Changing*. Chicago, Illinois: The University of Chicago Press.
- Billings, Loren, and Abigail Konopasky. 2020. The Role of Morphology in Ordering Verb-Adjacent Clitics: From Syntax to prosody in Bulgarian and Tagalog. In *Papers from the Workshop 'Language Change from a Generative Perspective'*, ed. by Artemis Alexiadou, Susann Fischer and Melita Stavrou, 1–26. Potsdam: Universitätsverlag Potsdam.
- Boneh, Nora, and Léa Nash. 2012. Core and non core datives in French. In *Variation in Datives: A Microcomparative Perspective*, ed. by Beatriz Fernandez and Ricardo Etxepare, 22-49. Oxford: OUP
- Bošković, Željko. 2004. Clitic Placement in South Slavic. *Journal of Slavic Linguistics* 12 (1/2): 37–90.
- Chomsky, Noam. 2004. Beyond explanatory adequacy. In *Structures and beyond*, ed. by Adriana Belletti, 104-125. Oxford: Oxford University Press.
- Chomsky, Noam. 2015. Problems of Projection. Extensions. In *Structures, Strategies and Beyond: Studies in honour of Adriana Belletti*, ed. by Elisa Di Domenico, Cornelia Hamann, and Simona Matteini, 1-16. Amsterdam: Benjamins.
- Chomsky, Noam. 2020. *The UCLA lectures*. <https://ling.auf.net/lingbuzz/005485>
- Chomsky, Noam. 2021a. Minimalism: Where Are We Now, and Where Can We Hope to Go. *Gengo Kenkyu* 160: 1–41. doi: 10.11435/gengo.160.0_1
- Chomsky, Noam. To appear. Genuine explanation. In *Issues in comparative morpho-syntax and language acquisition*, ed. by Giuliano Bocci, Daniele Botteri, Claudia Manetti & Vincenzo Moscati.
- Collins, Chris & Richard Kayne. 2020. Towards a Theory of Morphology as Syntax. Ms., NYU.
- Culicover, Peter, and Ray Jackendoff. 2005. *Simpler Syntax*. Oxford: Oxford University Press.
- D'Alessandro, Roberta, and Tobias Scheer. 2015. Modular PIC. *Linguistic Inquiry* 46(4): 593–624.
- Epstein, Samuel, Hisatsugu Kitahara, and Daniel Seely. 2016. Phase cancellation by external pair-merge of heads. *The Linguistic review* 33(1): 87–102.
- Folli, Raffaella & Heidi Harley 2006. Benefactives aren't Goals in Italian. In *Romance Languages and Linguistic Theory 2004*, ed. by Jenny Doetjes & Paz Gonzales, 121–142. Amsterdam: John Benjamins.
- Giorgi, Alessandra, and Giuseppe Longobardi. 1991. *The Syntax of Noun Phrases: Configuration, Parameters, and Empty Categories*. Cambridge: Cambridge University Press.
- Kayne, Richard. 1991. Romance Clitics, Verb Movement and PRO. *Linguistic Inquiry* 22: 647–686.
- Kayne, Richard. 1994. *The antisymmetry of syntax*. Cambridge (Mass.): The MIT Press.
- Larson, Richard. 2014. *On shell structure*. London: Routledge.
- Ledgeway, Adam, and Alessandra Lombardi. 2005. Verb Movement, Adverbs and Clitic Positions in Romance. *Probus* 17: 79–113.
- Manzini, M. Rita. 2022. Romance pronominal clitics as pure heads. *Journal of Linguistics*. DOI: [10.1017/S0022226722000159](https://doi.org/10.1017/S0022226722000159).
- Manzini, M. Rita, and Diego Pescarini. In press. The clitic string as a Pair merge sequence.

Glossa.

- Manzini, M. Rita, and Leonardo M. Savoia. 2007. *A unification of morphology and syntax. Studies in Romance and Albanian varieties*. London: Routledge.
- Martins, Ana Maria. 1994. Enclisis, VP-deletion and the nature of Sigma. *Probus* 6: 173-205.
- Matushansky, Ora. 2006. *Head movement in linguistic theory*. Cambridge (Mass.): MIT Press.
- Parsons, Terence. 1995. Thematic Relations and Arguments. *Linguistic Inquiry* 26(4): 635–662.
- Pescarini, Diego. 2021. *Romance object clitics*. Oxford: Oxford University Press.
- Riedel, Kristina. 2009. *The Syntax of Object Marking in Sambia. A comparative Bantu perspective*. Utrecht: LOT.
- Roberts, Ian. 2010. *Agreement and head movement: Clitics, incorporation, and defective goals*. Cambridge, Mass: The MIT Press.
- Selkirk, Elisabeth. 1974. French Liaison and the \bar{X} Notation. *Linguistic Inquiry* 5(4): 573-590.
- Sportiche, Dominique. 1996. Clitic constructions. In *Phrase structure and the lexicon*, ed. by Johan Rooryck and Laurie Zaring, 213-276. Dordrecht: Kluwer.
- Tegey, Habibullah. 1975. A Study of Pashto Clitics and Implications for Linguistic Theory. *Studies in the Linguistic Sciences*, 5: 154–196.
- Tortora, Christina. 2015. *A Comparative Grammar of Borgomanerese*. Oxford: Oxford University Press.

The Categorical Status of Embedded Questions in Japanese

Norio Nasu¹, Takayuki Akimoto², Koji Shimamura^{1,3}, Yusuke Yoda⁴

¹Kobe City University of Foreign Studies, ²Kogakuin University,

³Kanazawa Gakuin University, ⁴Toyo Gakuen University

1. Introduction

The primary purpose of this paper is to show bipartite aspects of embedded questions (EQs) in Japanese in terms of their categorial status. EQs are known to show the same distribution as noun phrases. For instance, not only a noun phrase but also an EQ can occupy the complement of a preposition as in (1a–b). However, some EQs occur in the environment where a noun phrase is disallowed, as indicated by the contrast between (1c) and (1d).

- (1) a. The result depends on [how much you study].
 b. The result depends on [your effort].
 c. John wondered [what the time was].
 d. *John wondered [the time].

The same contrast is found in Japanese. (2a) indicates that an EQ and a noun phrase can occur with a postposition. In contrast, the predicate *tohoonikureta* ‘was at a loss’ in (2b) is not compatible with a noun phrase but only occurs with an EQ.

- (2) a. Kekka-wa {[EQ]doredake benkyoosuru ka }/[DP kimino doryoku]-ni
 result-TOP how.much study Q your effort -on
 kakatteiru.
 depend
 ‘The result depends on {how much you study / your effort}.’
 b. John-wa {[EQ]doo hentoo-o u-beki ka }/*[DP hentoo] tohoonikureta.
 John-TOP how reply-ACC do-should Q reply was.at.a.loss
 ‘John was at a loss {how he should reply/*reply}.’

This paper demonstrates that EQs are divided into nominal and clausal types and that clausal EQs are further divided into argument and adjunct types.

There are three groups of predicates that occur with EQs. Predicates in Group 1 (e.g., *kininaru* ‘be curious’, *siraberu* ‘investigate’) occur with an EQ, which is either case-marked or caseless. They also take a nominal argument (see (3a, b)). Group 2 (e.g., *tohoonikureru* ‘be at a loss’) is compatible only with a caseless EQ, as illustrated by (4a, b). Predicates belonging to Group 3 (e.g., *kakaru* ‘depend’) occur both with a noun phrase and an EQ (see (5a, b)). This group minimally differs from Group 1 in that the EQ must be case-marked.

* We would like to thank the audience of GLOW in Asia XIII for their valuable comments and questions. Needless to say all remaining errors and inadequacies are ours. This research is supported by Grant-in-Aid for Scientific Research (C) (#18K00578) from the Japan Society for the Promotion of Science.

- (3) a. John-wa [EQ **dare-ga katta ka](-ga)** kininatta. (Group 1)
 John-TOP who-NOM won Q(-NOM) was.curious
 ‘John was curious about who had won.’
 b. John-wa [DP **kekka]-ga** kininatta.
 John-TOP result-NOM was.curious
 ‘John was curious about the result.’
- (4) a. John-wa [EQ **doo ioo ka](*-ni)** tohoonikureta. (Group 2)
 John-TOP how say Q (*-DAT) was.at.a.loss
 ‘John was at a loss what he would say.’
 b. *John-wa [DP **hentoo](-ni)** tohoonikureta.
 John-TOP reply (-DAT) was.at.a.loss
 ‘John was at a loss for the reply.’
- (5) a. Kekka-wa [EQ **doredake doryokusuru ka]*(-ni)** kakatteiru. (Group 3)
 result-TOP how.much make.effort Q *(-on) depend
 ‘The result depends on how much effort you make.’
 b. Kekka-wa [DP **kimino doryoku]-ni** kakatteiru.
 result-TOP your effort -on depend
 ‘The result depends on your effort.’

This paper is organized as follows. Section 2 shows that while case-marked EQs are nominal, caseless EQs are clausal. Section 3 demonstrates that clausal EQs are further divided into two types: the clausal EQ in Group 1 is an argument, whereas the one in Group 2 is an adjunct. Section 4 argues that a nominal EQ consists of nominal layers, *nP*, and DP above a clausal layer. Section 5 is the conclusion.

2. Nominal and Clausal Aspects of EQs

Based on diagnostics such as case-marking, prenominal modification, and coordination, this section demonstrates that some EQs are nominal while others are clausal. Let us begin with case-marking. As illustrated in (6), only noun phrases can be case-marked.

- (6) John-wa {[DP zibun-no namae]-o / [CP Bill-ga katta to] (*-o)} tugeta.
 John-TOP self-GEN name -ACC Bill-NOM won COMP(*-ACC) told
 ‘John told {his name / that Bill had won}.’

(7) shows the result of the case-marking test. Groups 2 and 3 are fairly straightforward. The former resists case-marking, indicating that the EQ is clausal. The EQ in the latter is nominal because case-marking is obligatory.

- (7) a. John-wa [EQ dare-ga katta ka](-ga) kininatta. (Group 1)
 John-TOP who-NOM won Q (-NOM) was.curious
 ‘John was curious about who had won.’
 b. John-wa [EQ nanto ioo ka](*-ni) tohoonikureta. (Group 2)
 John-TOP what say Q (*-DAT) was.at.a.loss
 ‘John was at a loss what he should say.’
 c. Kekka-wa [EQ doredake benkyoosuru ka]*(-ni) kakatteiru. (Group 3)
 result-TOP how.much study Q *(-on) depend
 ‘The result depends on how much you study.’

A murky case is Group 1. At first sight, case-marking is optional. It is tempting to conclude that the Group 1 EQ is nominal as it can be case-marked and that the caseless version results from the optional dropping of the nominative case particle. However, this analysis is untenable. Fukuda (1993) observes that, in contrast to the accusative case, the nominative case is hard to drop (see (8a, b)). As indicated by (9), the nominative case on the subject EQ cannot be dropped.

- (8) a. sono hon(-o) yonda hito b. kono hito*(-ga) yonda hon
 that book(-ACC) read man this man*(-NOM) read book
 ‘the man who read that book’ ‘the book which this man read’
 (adapted from Fukuda 1993: 169)

- (9) [Dare-ga kuru ka]*(-ga) zyuyyoo da.
 who-NOM come Q *(-NOM) important COP
 ‘Who will come is important.’

It follows that case-marking on a Group 1 EQ is not optional, though it looks so. There are, in fact, two versions of EQs in this group. One is case-marked, and the other is caseless.

The same observation applies to accusative-case marking. Some Group 1 predicates such as *sirabe-* ‘investigate’ can mark an EQ with the accusative case. Although case marking looks optional in (10), the case-marked and the caseless versions are not in free variation.

- (10) John-wa [dare-ga kita ka](-o) sirabeta. (Group 1)
 John-TOP who-NOM came Q (-ACC) investigated
 ‘John investigated who had come.’

Kobayashi (2000) and Endo (2007) observe that case-marked and caseless EQs behave differently with respect to the scope of a *wh*-phrase. While the *wh*-phrase in a caseless EQ can take either embedded or matrix scope, the one in a case-marked EQ can take only embedded scope. For concreteness, let us consider the following pair.

- (11)a. John-wa [Mary-ga nani-o katta ka] sirabete-iru {nokai/ndai}?
 John-TOP Mary-NOM what-ACC bought Q investigating-is {-WHQ/+WHQ}
 i. ‘Is John investigating [what Mary bought]?’
 ii. ?‘What is John investigating whether Mary bought?’
 b. John-wa [Mary-ga nani-o katta ka]-o sirabete-iru {nokai/*ndai}?
 John-TOP Mary-NOM what-ACC bought Q-ACC investigating-is {-WHQ/+WHQ}
 i. ‘Is John investigating [what Mary bought]?’
 ii. *‘What is John investigating whether Mary bought?’

Yoshida (2019) notes that colloquial Japanese has two interrogative particles. The particle *nokai* is used only in a non-*wh*-question, while *ndai* is used only in a *wh*-question. When the EQ shows up without case as in (11a), each of these particles can be used in accordance with the scope interpretation of the *wh*-phrase. The particle *nokai* is compatible only with the embedded reading of the *wh*-phrase because the matrix clause becomes a polar question. When the *wh*-question particle *nodai* is used, the matrix scope reading becomes available. In contrast, the matrix scope reading is lost when the EQ is case-marked, as in (11b). Furthermore, this

sentence tolerates only the polar question particle. It follows that the optionality of case-marking is only apparent. Case-marked and caseless EQs belong to different categories. Only the former is nominal. The latter does not result from simple case dropping but is intrinsically clausal.

Another criterion is prenominal modification. As illustrated in (12), nouns can be modified by demonstratives and relative clauses, whereas clauses cannot. The examples in (13) show that while the EQs of Groups 1 and 3 are compatible with prenominal modification, the Group 2 EQ is not.

- (12) John-wa **{ano/reino}** [maeni Bill-ga itteita]
 John-TOP {that/aforementioned} before Bill-NOM mentioned
 {[DPUwasa-o] / *[CP Mary-ga kekkonsita to]} sinziteiru.
 rumor-ACC Mary-NOM married COMP believe
 ‘John believes the rumor which Bill mentioned before.’
 ‘*John believes that [that Mary had married] which Bill mentioned before.’ (lit.)
- (13) a. John-wa **{ano/reino}** [maeni Bill-ga itteita] (Group 1)
 John-TOP {that/aforementioned} before Bill-NOM mentioned
 [EQ kaisya-ga doo zinkenhi-o osaeru ka]*(-ga) kininatte-iru.
 company-NOM how labor.cost-ACC control Q *(-NOM) curious-is
 ‘John is curious about that/aforementioned [how the company would control the labor cost] which Bill mentioned before.’ (lit.)
- b. *John-wa **{ano/reino}** [zutto sinpaisiteita] (Group 2)
 John-TOP {that/aforementioned} all.this.while worried
 [EQ dare-ni soodansureba ii ka] tohoonikureteiru.
 who-DAT consult good Q is.at.a.loss
 ‘John is at a loss that/aforementioned [who he should consult] which he has been worried about.’ (lit.)
- c. Kaisya-no syoorai-wa **{ano/reino}** [sikirini] (Group 3)
 company-GEN future-TOP {that/aforementioned} often
kabunusi-ga mondai-ni siteiru] [EQ donokurai rieki-o
 stockholder-NOM question-in do how.much profit-ACC
 age-rareru ka] -ni kakatteiru.
 yield-can Q -on depend
 ‘The company’s future depends on that/aforementioned [how much profit it can yield] which stockholders often put into question.’ (lit.)

Recall that Group 1 EQs can be either case-marked or caseless. It is worth noting that only a case-marked EQ can be modified by prenominal modifiers, as illustrated by (13a). This modification pattern reinforces the observation that a case-marked EQ is nominal while a caseless EQ is clausal. Recall also that while a Group 2 EQ cannot be case-marked, a Group 3 EQ must be case-marked. As predicted, the former resists prenominal modification, and the latter is compatible with it (see (11b, c)).

The last test is a coordination by the conjunction *to* ‘and’. This conjunction is used for coordinating nominal categories but not for clausal coordination.

- (14)a. John-wa [DP kono uwasa] **to** [DP ano uwasa]-o sinziteiru.
 John-TOP this rumor and that rumor-ACC believe
 ‘John believes this rumor and that rumor.’
- b. *John-wa [CP Bill-ga gakusei da to] **to** [CP Mary-ga sensei
 John-TOP Bill-NOM student COP COMP and Mary-NOM teacher
 da to] sinziteiru.
 COP COMP believe
 ‘John believes that Bill is a student and that Mary is a teacher.’

As illustrated by (15a) below, case-marking is obligatory when Group 1 EQs are coordinated by *to*. The obligatory case-marking indicates that the coordinated EQs are nominal. Group 3 EQs are also compatible with *to*-coordination (see (15c)). In contrast, Group 2 EQs are clausal, as indicated by the lack of case-marking. As predicted, they resist this type of coordination (see (15b)).

- (15)a. John-wa [Ohtani-ga hoomuran-o nanbon utta ka] **to** (Group 1)
 John-TOP Ohtani-NOM home.run-ACC how.many hit Q and
 [Guerrero-ga nankai sansinsita ka]*(-ga) kininatta.
 Guerrero-NOM how.many.times struck.out Q*(-NOM) was.curious
 ‘John was curious about how many home runs Ohtani had hit and how many times
 Guerrero had struck out.’
- b. *John-wa [sigoto-o hikiukeru beki ka] **to** (Group 2)
 John-TOP job-ACC undertake should Q and
 [dare-ni soodansu beki ka] tohoonikureteiru.
 who-DAT consult should Q is.at.a.loss
 ‘John is at a loss whether he should undertake the job and who he should consult.’
- c. Kaisya-no syoorai-wa [donokurai rieki-o age-rareru ka] (Group 3)
 company-GEN future-TOP how.much profit-ACC yield-can Q
to [donokurai keihi-o kezur-eru ka]-ni kakatteiru.
 and how.much cost-ACC reduce-can Q -on depend
 ‘The future of the company depends on how much profit it can yield and how
 much cost it can reduce.’

To summarize the discussion so far, there are two types of EQ. One is nominal, and the other is clausal. Group 1 EQs are bi-categorical in that they are nominal when case-marked while clausal without case-marking. Group 2 is clausal, and Group 3 is nominal.

3. Caseless (Clausal) EQs: Arguments or Adjuncts?

This section turns to clausal aspects of EQs. Recall that clausal EQs belong to either Group 1 or Group 2. Using four diagnostics, including omission, adjunct condition effect, ellipsis, and attachment of a focus particle *sae*, we attempt to clarify whether they are arguments or adjuncts. It will turn out that a relatively clear distinction is made between the two groups. The first criterion is omission. The common observation is that while arguments are obligatory in an out-of-the-blue utterance, adjuncts are optional. In this respect, a Group 1 EQ in (16a) behaves as an argument and a Group 3 EQ in (16b) behaves as an adjunct.

- (16) a. *John-wa \emptyset_{EQ} kininata. b. John-wa \emptyset_{EQ} tohoonikurete-iru.
 John-TOP was.curious John-TOP at.a.loss-is
 ‘John was curious.’ ‘John is at a loss.’

Another criterion is adjunct condition effects. Given that an adjunct clause forms an island, it is predicted that an EQ blocking extraction is an adjunct clause. To test this prediction, we use comparative deletion, which involves operator movement, according to Kikuchi (1989). However, there is a complication. As illustrated in (17), only a subset of adjunct clauses displays this effect.

- (17) a. John-wa [Bill-ga [t_i **nomi nagara**] ronbun-o kaita yorimo Op_i]
 John-TOP Bill-NOM drink while paper-ACC wrote than
 harukani ookuno biiru- o_i nonda.
 much more beer-ACC drank
 ‘John drank much more beer_i than Bill wrote a paper while drinking e_i .’ (lit.)
 b. *John-wa [Bill-ga [t_i **moratta noni**] humandatta yorimo Op_i]
 John-TOP Bill-NOM received though unsatisfied than
 harukani ookuno hana- o_i Mary-ni ageta.
 much more flower-ACC Mary-DAT gave
 ‘John gave Mary much more flowers_i than Mike was unsatisfied though he received e_i .’ (lit.)

Sato (1999) points out that the different sensitivity to the adjunct condition is attributed to the position to which the adjunct clauses are adjoined. He argues that adjunct clauses adjoined to a lexical projection do not exhibit adjunct condition effects; only those adjoined to functional projections are islands. The *nagara*-clause in (17a) is a VP-adjunct, whereas the *noni*-clause in (17b) is adjoined to a position higher than VP. This difference is reflected in the interpretation of the focus particle *sae*. Consider the following examples.

- (18) a. John-wa biiru-o nomi nagara kuruma-o untensi-**sae** sita.
 John-TOP beer-ACC drink while car-ACC drive-even did
 ‘John even drove a car while drinking beer.’
 b. Mary-wa 8-saino musuko-ga biiru-o nonda noni home-**sae** sita.
 Mary-TOP 8-year.old son-NOM beer-ACC drank though praise-even did
 ‘Mary even praised him though her 8-year-old son drank beer.’

The *nagara*-clause in (18a) is in the scope of the focus particle *sae*, which yields the following interpretation: “John drove a car while doing something else. Among those acts, drinking beer was the last thing the speaker expected Bill to do.” However, the *noni*-clause in (18b) is excluded from the scope of *sae*. Therefore, the sentence does not have the following interpretation: “Mary praised her son despite his mischievous acts. Among those acts, drinking beer was the last thing the speaker expected him to.”. The particle *sae* is adjoined to the verb in (18a, b). Koizumi (1993) observes that the verb-adjoined *sae* takes scope over constituents inside VP. However, a VP-external constituent is excluded from its scope.¹ Given this property,

¹ For example, while (i) has the readings (a) and (b), it does not allow (c). Since the topic-marked phrase is in CP, it is excluded from the scope of the focus particle.

along with the data in (18), it follows that the *nagara*-clause is a VP-internal element while the *noni*-clause is a VP-external element.

Having observed that only adjunct clauses adjoined to functional projections block extraction, let us consider whether clausal EQs display this effect.

- (19)a. ?[Bill-ga [**t_i** **yom-eru ka**] kininatteiru yorimo Op_i] (Group 1)
 Bill-NOM read-can Q curious than
 harukani ookuno hon-o_i John-wa yonde-iru.
 much more book-ACC John-TOP read-has
 ‘John has read much more books_i than Bill is curious whether he can read e_i.’
- b. ?[Bill-ga [**t_i** **yom-eru ka**] tohoonikurete-iru yorimo Op_i] (Group 2)
 Bill-NOM read-can Q at.a.loss-is than
 harukani ookuno hon-o_i John-wa yonde-iru
 much more book-ACC John-TOP read-has
 ‘John has read much more books than Bill is at a loss whether he can read e_i.’

Since neither Group 1 nor Group 2 shows a strong adjunct condition effect, a decisive conclusion is hard to draw. All that can be said is that the EQs in these examples are VP-*elements*. They can be either a VP-internal argument or a VP-adjunct, both of which tolerate extraction. In order to obtain a robust conclusion, we need more diagnostics.

Ellipsis also serves to distinguish between arguments and adjuncts. A common observation relevant to this point is that while an argument can be elided on its own, an adjunct cannot (Oku 1998, among others). Consider the following pair.

- (20)a. John-wa kuruma-o aratta ga, Bill-wa arawa-naka-tta.
 John-TOP car-ACC washed but Bill-TOP wash-NEG-PST
 ‘John washed the car, but Bill did not wash ~~the car~~.’
- b. John-wa kuruma-o teinein aratta ga, Bill-wa kuruma-o arawa-naka-tta.
 John-TOP car-ACC carefully washed but Bill-TOP car-ACC wash-NEG-PST
 ‘John washed the car carefully, but ‘Bill didn’t wash the car.’
 Not: ‘..., but Bill didn’t wash the car ~~carefully~~.’ (i.e. no adjunct ellipsis reading.)

Although the second conjunct in (20a) does not contain the object argument *kuruma-o* ‘car-acc’, it has the reading that Bill did not wash the car, whereby the object is elided. The second conjunct in (20b) lacks the adverb *teineini* ‘carefully’ in the first conjunct. However, it fails to have an ellipsis reading. It only means that Bill did not wash the car, but it does not mention how he washed it. The contrast in (20) leads to the conclusion that an adjunct cannot be elided alone.

The following example involves a Group 1 EQ. The second conjunct (21b) has a reading, whereby the EQ appearing in the antecedent sentence (21a) is elided on its own. This means that the relevant EQ is an argument.² However, the EQ ellipsis reading is unavailable in (22), where a Group 2 EQ occurs.

- (i) John-wa [VP biiru-o nomi-sae] sita.
 John-TOP beer-ACC drink-even did
 (a) ‘John even drank beer.’ / (b) ‘John drank even beer.’ / (c) *‘Even John drank beer.’

² A possible objection to this conclusion is that the ellipsis reading in (21b) does not result from the ellipsis of

- (21)a. John-wa [zibun-no tuma-ga ikite-iru ka] sinpai site-ita kedo,
 John-TOP self-GEN wife-NOM alive-is Q worry doing-was but
 ‘John was worried about whether his wife was alive, but ...’
- b. Bill-wa sinpai site-i-nakat-ta.
 Bill-TOP worry doing-be-NEG-PST
 ‘Bill was not worried about whether John’s wife was alive.’ (strict)
 ‘Bill_i was not worried about whether his_i wife was alive.’ (sloppy)
- (22)a. John-wa [zibun-ga doo su-beki ka] gakkoo-de tohoonikuretei-ta kedo,
 John-TOP self-NOM how do-should Q school-at be.at.a.loss-PST but
 ‘John was at a loss at school what he should do, but ...’
- b. Bill-wa zitaku-de tohoonikuretei-nakat-ta.
 Bill-TOP home-at be.at.a.loss-NEG-PST
 ‘Bill was not at a loss at home.’
 Not: ‘Bill was not at a loss at home ~~what he should do.~~’

(22b) can only mean that Bill was at a loss at home without mentioning what he was at a loss about. This interpretation indicates that (22b) does not involve the ellipsis of the EQ appearing in the antecedent (22a). The unavailability of this option leads to the observation that the relevant EQ is an adjunct.

Finally, co-occurrence with the focus particle *sae* is also sensitive to the argument-adjunct distinction. This particle can take scope over a constituent larger than the one it is attached to. Thus, in (23), although it is attached to the object noun phrase, it takes scope over vP too.

- (23) John_i, who is under age, not only drank alcohol, ...
 pro_i tabako-sae sutta.
 tobacco-even smoked
even > tobacco: ‘he smoked even tobacco.’ (he smoked something else as well)
even > vP: ‘he even smoked.’ (he did something else as well)

the EQ alone but from that of a larger constituent. Suppose one assumes that the headless vP undergoes ellipsis after the predicate raises out of vP. In that case, it is not detectable whether the EQ is an argument or an adjunct (Headless vP-ellipsis (Funakoshi 2014)). The vP-ellipsis analysis presupposes overt V-raising. However, the predicate *sinpai* ‘worry’ in (21) is a verbal noun (VN). It is reported that a VN remains in situ. Hayashi (2015) observes that when the VN predicate, *kikoku* ‘returning’, is retained as in (ib), a null adjunct reading is unavailable. In contrast, when the VN is contained in the ellipsis domain as in (ic), it becomes available.

- (i) a. Taro-wa L.A.-keeyude Nihon-e kikoku sita kedo,
 Taro-TOP L.A.-via Japan-to returning(VN) did but
 ‘Taro went back to Japan via L.A., but ...’
- b. Ziro-wa kikoku si-nakat-ta.
 Ziro-TOP returning(VN) do-NEG-PST
 ‘Ziro did not go back to Japan.’
 Not: ‘Ziro did not go back to Japan via L.A.’ (i.e. no adjunct ellipsis reading)
- c. Ziro-wa si-nakat-ta.
 Ziro-TOP do-NEG-PST
 ‘Ziro did not go back to Japan via L.A.’ (i.e. adjunct ellipsis reading available)

(Hayashi 2015: 77–78)

The VN predicate remains inside VNP in (21b). Ellipsis is not applied to the larger constituent involving the VN but to the EQ alone.

To account for the larger scope, Aoyagi (1998) proposes that this particle undergoes LF raising to a higher functional head to take scope over vP. Keeping this in mind, consider the following examples.

- (24) John-wa sekininsya-na noni, ...
 John-TOP person.in.charge-COP though
 ‘Though he was a person in charge, ...’
- a. [nani-o su-beki ka-sae] wasurete-ita. (Group 1)
 what-ACC do-should Q-even forgotten-had.
even > EQ: ‘he had forgotten even what to do.’ (he forgot something else as well)
even > vP: ‘he had even forgotten what to do.’ (he did something else as well)
- b. [nani-o su-beki ka(*-sae)] tohoonikurete-ita (koto) (Group 2)
 what-ACC do-should Q-even at.a.loss-was fact
 ‘John was at a loss even what to do.’

Although the focus particle can be attached to the Group 1 EQ, it cannot be attached to the Group 2 EQ. This is in parallel with (25).

- (25)a. John-wa [Bill-ga baka da to-sae] itta.
 John-TOP Bill-NOM fool COP COMP-even said
 ‘John said even that Bill was a fool.’
- b. John-wa [Mary-ga kuru to(*-sae)] heya-o deteitta.
 John-TOP Mary-NOM come when-even room-ACC left
 ‘John left the room even when Mary came.’

In (25a), *sae* is attached to the declarative complement clause, and the sentence is well-formed. On the other hand, it is incompatible with a temporal adjunct clause as in (25b). The same argument-adjunct asymmetry emerges in (24). That is, while the Group 1 EQ is an argument, the Group 2 EQ is an adjunct. As discussed earlier, a Group 2 EQ does not exhibit an adjunct condition effect, characteristic of an adjunct clause adjoined to a lexical projection. It follows then that a Group 2 EQ is a VP-adjunct.

4. The Structure of Nominal EQs

4.1 DP and nP

This section demonstrates that Japanese nominal EQs have the following structure: the clausal part (CP) is dominated by two nominal projections nP and DP.

- (26) [_{DP} Spec [_{nP} (Modifier) [_{nP} [_{CP} ...] n]] D]

As mentioned earlier, a nominal EQ is able to co-occur with prenominal modifiers such as demonstratives and relative clauses.

- (27) Kyoo-no kaigi-de {ano/reino} [maeni hanasiatta]
 today-GEN meeting-in {that/aforementioned} before discussed
 [dooyatte kakaku-o osaeru ka]-ga gidai-ni nobotta.
 how price-ACC control Q-NOM agenda-on was.put

‘That issue of how we control the price that we had discussed before was put on the agenda in today’s meeting.’

Furuya (2008) observes that the demonstrative is located in Spec-DP in a head-final language like Japanese. The placement of such an element in Spec-DP accounts for the illegitimacy of extraction from a referential/definite noun phrase. According to Furuya, a numeral quantifier can either stay in the associated noun phrase or float out of it as in (28). However, floating is blocked when the associated noun phrase is definite, as illustrated by (29). The noun phrase *sono hannin* ‘those criminals’ is definite, referring to the same individuals appearing in the preceding context.

- (28) (3-nin) Suzuki sensei-wa [gakusei (3-nin)]-o sikatta.
 3-CLF Suzuki teacher-TOP student 3-CLF -ACC scolded
 ‘Prof. Suzuki scolded three students.’ (Furuya 2008: 155)

- (29) I heard that (the) three criminals ran away.
 *3-nin_i sonogo keisatu-wa [sono hannin t_i]-o tukamaeta.
 3-CLF later police-TOP those criminal -ACC caught
 ‘Later, the police caught those three criminals.’ (intended) (Furuya 2008: 156)

The illegitimate floating in (29) is attributable to the unavailability of this position on the assumption that extraction out of a noun phrase takes place via Spec-DP.

A similar blocking effect is observed in the EQ construction. As illustrated by (30), the extraction of a null operator is blocked in the presence of a demonstrative, which indicates that the EQ contains a DP layer.

- (30) [Op_i [Bill-ga [(*sono/*reino) [Mary-ga t_i yonda ka]]-o
 Bill-NOM that / aforementioned Mary-NOM read Q -ACC
 kinisite-iru] yorimo] harukani ookuno hon-o John-wa yonda.
 concerned-is than much more book-ACC John-TOP read
 ‘John read much more books than Bill is concerned about that /aforementioned
 whether Mary read that we discussed before.’ (lit.)

Let us now turn to discuss the presence of nP. We adopt Kornfilt and Whitman’s (2011) Functional Nominalization Thesis (FNT), which states that “[n]ominal properties of a nominalization are contributed by a nominal functional projection” (p. 1298). This means that items associated with nominals such as possessives, demonstratives, and prenominal adjectives target a constituent that has already been nominalized. Bearing this in mind, consider the following example.

- (31) Kyoo-no kaigi-de ano zyuyyoo-**{na/*ni}**
 today-GEN meeting-in that important-**{ADJ/*ADV}**
 [EQ dooyatte kakaku-o osaeru ka]-ga gidai-ni nobotta.
 how price-ACC control Q -NOM agenda-on was.put
 ‘That important how we control the price was put on the agenda in today’s meeting.’
 (lit.)

Since the modifier *zyuuyoo*- ‘important’ carries an adjectival affix rather than an adverbial one, it is merged with a nominalized constituent, according to the FNT. Notice that since it is preceded by the demonstrative in Spec-DP, it merges with D’. We assume that the adjective is merged with nP. It could be argued that it is merged with D’. However, this option is unavailable due to the obligatory adjectival modification in the English poss(essive)-*ing* gerund.

- (32)a. John’s {*careful / carefully} slicing the cheese
 b. [DP John’s [D’ D [VP {*careful/carefully} slicing the cheese]]]
 c. [DP John’s [D’ careful [D’ D [VP slicing the cheese]]]]

The poss-*ing* gerund has the structure (32b) (Abney 1987, among others). In this structure, D is directly merged with VP, which tolerates only adverbial modification. If an adjective could be merged with D’ as in (32c), the poss-*ing* gerund would incorrectly allow adjectival modification. It follows that an adjective does not occur inside DP but is merged with a lower nominal projection, nP.

4.2 Extensions: Nominative-Genitive Conversion

A nominal EQ behaves in parallel with a clause in one respect. Neither of them licenses nominative-genitive conversion (NGC). In Japanese, subjects may be marked either in the nominative case or the genitive case in certain clauses, including relative clauses and nominalized complement clauses, as illustrated below.

- (33)a. John-wa [hi-**{ga/no}** atara-nai] heya-ni sundeita.
 John-TOP sunlight-**{NOM/GEN}** shine-NEG room-in lived
 ‘John lived in a room that didn’t get sunlight.’
 b. John-wa [Mary-**{ga/no}** kuru {koto/no}]-o sitteiru.
 John-TOP Mary-**{NOM/GEN}** come NMLZ-ACC know
 ‘John knows that Mary will come.’

However, NGC is not possible in all types of clauses. For instance, a declarative clause headed by the complementizer *to* does not allow it (see (34a)). It is noteworthy that the genitive subject is not possible in a nominal EQ either (see (34b)).

- (34)a. John-wa [sono heya-wa hi-**{ga/*no}** atara-nai to] itta.
 John-TOP the room-TOP sunlight-**{NOM/*GEN}** shine-NEG COMP said
 ‘John said that the room didn’t get sunlight.’
 b. John-wa [Mary-**{ga/*no}** kuru ka]-ga kininatta.
 John-TOP Mary-**{NOM/*GEN}** come Q -NOM was.curious
 ‘John was curious whether Mary would come.’

Then the question is why the nominal EQ behaves in parallel with a non-nominal clause rather than with a nominalized clause with respect to NGC.

Pertinent to our discussion is Complementizer Blocking Effect (CBE) discussed by Hiraiwa (2005). It refers to the ban on NGC in the presence of an overt complementizer, as in (35b).

- (35)a. [John-**{ga/no}** arawareru] kanoosei-wa hikui.
 John-**{NOM/GEN}** show.up possibility-TOP low
 ‘The possibility that John will show up is low.’ (lit.)
- b. [John-**{ga/*no}** arawareru **toiu**] kanoosei-wa hikui.
 John-**{NOM/*GEN}** show.up COMP possibility-TOP low
 ‘The possibility that John will show up is low.’ (lit.)

The illegitimate NGC in (34b) is also attributable to the CBE. That is to say, given that EQ is a full-fledged CP involving ForceP in the sense of Rizzi (1997), it projects ForceP, which in turn is nominalized as a result of the merger with *n* as illustrated below.

- (36)... [_{NP} [_{ForceP} [_{FinP} [_{TP} Bill would come] Fin] *ka*-Force]_n] ...

Under Hiraiwa’s analysis, NGC becomes possible when C that immediately takes TP assumes a nominal feature. However, this is impossible in (36) because what is nominalized is ForceP, and hence FinP, which immediately takes TP, does not carry a nominal feature.

Clauses with NGC and those without it display the difference in the predicate form. The predicate in the former is realized in the predicate-adnominal (P.-A.) form as in (37a, b), whereas the one in the latter is realized in the conclusive form as in (37c, d).

- (37)a. [seiseki-**{ga/no}** yuusyuu-**{na/*da}** gakusei
 grade-**{NOM/GEN}** excellent-**{is.P.-A./*is.CONCL}** student
 ‘students with excellent grades’
- b. John-wa [Mary-**{ga/no}** yuusyuu-**{na/*da}** {no/koto}]-o
 John-TOP Mary-**{NOM/GEN}** excellent-**{is.P.-A./*is.CONCL}** NMLZ -ACC
 sitteiru.
 know
 ‘John knows that Mary is excellent.’
- c. John-wa [Mary-**{ga/*no}** yuusyuu-**{*na/da}** to] itta.
 John-TOP Mary-**{NOM/*GEN}** excellent-**{*is.P.-A./is.CONCL}** COMP said
 ‘John said that Mary was excellent.’
- d. John-wa [dare-**{ga/*no}** yuusyuu-**{*na/da}** ka]-o sitteiru.
 John-TOP who-**{NOM/*GEN}** excellent-**{*is.P.-A./is.CONCL}** Q-ACC know
 ‘John knows who is excellent.’

In Hiraiwa’s (2005) model, NGC and the P.-A. form are correlated and reduced to the nominal feature carried by the TP-selecting complementizer. Then, the illegitimacy of the P.-A. form in the EQ in (37d) is also rooted in the absence of the nominal feature in Fin since the EQ is nominalized by the nominal functional head *n* instead of nominal feature assignment.

There is another influential approach to NGC called the D-licensing analysis. Miyagawa (2011) argues that NGC is not a simple case alternation phenomenon but that nominative and genitive subjects are licensed in different structures. The nominative subject is licensed via Agree with T that inherits ϕ -features from C as in (38a). The genitive subject is licensed by D via Agree in the structure that lacks a CP layer, as illustrated in (38b).

- (38)a. [CP C [TP T [vP Nominative Subject [v' ...]]]]
 b. [DP D [TP T [vP Genitive Subject [v' ...]]]] (order irrelevant)

Our analysis of nominal EQs is compatible with this approach as well. Since an EQ involves C, the nominative subject is licensed. However, the licensing of the genitive subject by D is impossible. On the assumption that D, as well as C, is a phase head, as soon as D is merged in the structure (26), TP is spelled out, and the subject becomes inaccessible from D (due to Chomsky's 2000 Phrase Impenetrability Condition). Consequently, the genitive subject fails to occur in an EQ. In summary, we are neutral to these two different views of NGC. Whichever view may be employed, the absence of NGC in EQs can be successfully accounted for in our analysis.

5. Conclusion

Japanese EQs are either clausal or nominal. Clausal EQs are either arguments or adjuncts. Although clausal and nominal EQs look identical apart from case-marking, they have different internal structures. The nominal type contains DP and *nP* layers on top of CP. Clause structure is often discussed based on visible morphemes and constituents on the clausal periphery. However, the size variation among seemingly identical EQs in Japanese argues against this approach and shows that what you see is not always what you get.

References

- Abney, Steven Paul. 1987. The English noun phrase in its sentential aspect. Doctoral dissertation, MIT.
- Aoyagi, Hiroshi. 1998. *Nihongo no zyosi to kinoohantyyuu* (Particles and functional categories in Japanese). Tokyo: Hituzi Syobo.
- Chomsky, Noam. 2000. Minimalist inquiries: the framework. In *Step by step: Essays on minimalist syntax in honor of Howard Lasnik*, ed. by Roger Martin, David Michaels, and Juan Uriagereka, 89–155. Cambridge, MA: MIT Press.
- Endo, Yoshio. 2007. *Locality and information structure: A cartographic approach to Japanese*. Amsterdam: John Benjamins.
- Fukuda, Minoru. 1993. Head government and case marker drop in Japanese. *Linguistic Inquiry* 24: 168–172.
- Funakoshi, Kenshi. 2014. Syntactic head movement and its consequences. Doctoral dissertation, University of Maryland, College Park.
- Furuya, Kaori. 2008. DP hypothesis for Japanese “bare” noun phrases. In *University of Pennsylvania Working Papers in Linguistics 14: Proceedings of the 31st Annual Penn Linguistics Colloquium*, ed. by Lukasz Abramowicz, Stefanie Brody, Toni Cook, Ariel Diertani, Aviad Eilam, Keelan Evanini, Kyle Gorman, Laurel MacKenzie, and Joshua Tauberer, 149–162. Philadelphia: University of Pennsylvania.
- Hayashi, Shintaro. 2015. Head movement in an agglutinative language. Doctoral dissertation, Yokohama National University.
- Hiraiwa, Ken. 2005. Dimensions of symmetry in syntax: Agreement and clausal architecture. Doctoral dissertation, MIT.
- Kikuchi, Akira. 1989. Comparative deletion in Japanese. Ms., Yamagata University.
- Kobayashi, Akiko. 2000. The third position for a wh-phrase. *Linguistic Analysis* 30: 177–215.
- Koizumi, Masatoshi. 1993. Modal phrase and adjuncts. In *Japanese Korean Linguistics Vol. 2*, ed. by Patricia M. Clancy, 409–428. Stanford, CA: CSLI Publications.
- Kornfilt, Jaklin, and John Whitman. 2011. Afterword: Nominalizations in syntactic theory. *Lingua* 121: 1297–1313.
- Miyagawa, Shigeru. 2011. Genitive subjects in Altaic and specification of phase. *Lingua* 121:1265–1282.
- Oku, Satoshi. 1998. A theory of selection and reconstruction in the minimalist perspective. Doctoral dissertation, University of Connecticut.
- Rizzi, Luigi. 1997. The fine structure of the left periphery. In *Elements of grammar*, ed. by Liliane Haegeman, 281–337. Dordrecht: Springer.
- Sato, Naoto. 1999. Nihongo niokeru hukasi karano tekisyutu (Extraction from adjuncts in Japanese). In *Kotoba no kaku to syuuen* (The core and the periphery of language), ed. by Shige-Yuki Kuroda and Masaru Nakamura, 245–264. Tokyo: Kurosio Publishers.
- Yoshida, Tomoyuki. 2019. Complement selection and wh-scope in Japanese. *Journal of East Asian Linguistics* 28: 1–27.

Light nouns and extraction from null clausal arguments*

Shuki Otani¹, Yuta Tatsumi²

¹Osaka University (otani.tog@gmail.com)

²Meikai University (ytats0074@meikai.ac.jp)

1. Introduction: Overt extraction from null positions

It has been assumed that there are two types of anaphora in natural languages (Hankamer and Sag 1976). The two types of anaphora have been termed *surface anaphora* and *deep anaphora*. One of the differences between surface and deep anaphora is only the former has an internal structure in syntax. According to Merchant (2013), one reliable test for surface anaphora is the possibility of extraction. If extraction from a null position is possible, the internal structure of the null position must be present in syntax. Let us consider the examples in (1).

- (1) a. Which films₁ did he refuse to see t₁, and which films₂ did he agree to see t₂?
 b. *Which films₁ did he refuse to see t₁, and which films₂ did he agree Δ? (Δ = [to see t₂])
 (Merchant 2013: 538)

(1a) shows that an overt wh-movement is possible from a VP-ellipsis site. VP-ellipsis is an instance of surface anaphora; the elided site has its internal structure, as shown in (1a). An overt wh-phrase can move from the elided VP. However, an overt wh-movement is impossible from the null position in (1b). This position is analyzed as a deep anaphor, which lacks its internal structure in syntax. Overt extraction of a wh-phrase is thus impossible in (1b).

Let us now consider overt extraction out of an embedded clause in Japanese. As shown in (2), an embedded clause can be phonologically null in Japanese.

- (2) Taro-wa [CP Hanako-ga hon-o yonda to] itta. Ziro-mo [CP Δ] itta.
 Taro-TOP Hanako-NOM book-ACC read C said Ziro-also said
 Lit. 'Taro said that Hanako read a book. Ziro said Δ.'

It has been observed that overt extraction out of an elided embedded clause is impossible in Japanese (Saito 2007, Takita 2010, Kasai 2014, Sakamoto 2019). The relevant examples are provided in (3).

- (3) Overt extraction out of a null embedded CP
 a. Hon-o₁ Taro-wa [CP Ziro-ga t₁ yonda to] omotta kedo.
 book-ACC Taro-TOP Ziro-NOM read C thought but
 Lit. 'Although a book₁, Taro thought that read t₁.'

*We are immensely grateful to Seiki Ayano, Satoshi Ito, Tommy Tsz-Ming Lee, Hiroaki Nagatomi, Mamoru Saito, Kensuke Takita, and Hideharu Tanaka for insightful comments. We would also like to thank the audience at GLOW in Asia XIII and the LCCC research group at Osaka University, as well as the following people: Yuto Hirayama, Ryoichiro Kobayashi, Kenta Mizutani, Kazushige Moriyama, and Koji Sugisaki. All remaining errors are of course our own. This research is partially supported by JSPS KAKENHI Grant Number 21K20016 awarded to the second author.

- b. Ronbun-o₂ Hanako-wa [_{CP} Ziro-ga t₂ yonda to] omotta.
 article-ACC Hanako-TOP Ziro-NOM read C thought
 Lit. ‘An article₂, Hanako thought that Ziro read t₂.’
- c. *Ronbun-o₂ Hanako-wa [_{CP} Δ] omotta.
 article-ACC Hanako-TOP thought
 Lit. ‘An article₂, Hanako thought Δ.’

The sentence in (3a) is the antecedent for the sentences in (3b) and (3c). An overt element can move out of an embedded clause, as in (3a,b). However, when an embedded clause is phonetically null, an overt element cannot be extracted out of the null clause, as shown in (3c).

It has also been observed that an overt element can be extracted from a null embedded clause in the Exceptional Case-Marking (ECM) construction (Tanaka 2008, Sakamoto 2017, 2019). An example of the ECM construction is provided in (4).

- (4) Taro-ga [Hanako-(ga/o) tensai da to] itta.
 Taro-NOM Hanako-NOM/ACC genius COP C said
 ‘Taro said that Hanako is a genius.’

In (4), the embedded subject, *Hanako*, can be marked by the accusative case particle of *-o*. When an ECM clause is phonetically null, overt extraction from the null clause is not allowed, as in (5c).

- (5) a. Taro-wa Ayako-o₁ orokanimo [t₁ tensai da to] itta.
 Taro-TOP Ayako-ACC stupidly genius COP C said
 Lit. ‘Taro, Ayako₁, stupidly said that t₁ is a genius.’
- b. Ziro-wa Kanako-o₂ orokanimo [t₂ tensai da to] itta.
 Ziro-TOP Kanako-ACC stupidly genius COP C said
 Lit. ‘Ziro, Kanako₂, stupidly said that t₂ is a genius.’
- c. *Ziro-wa Kanako-o₂ orokanimo [Δ] itta.
 Ziro-TOP Kanako-ACC stupidly said
 Lit. ‘Ziro, Lanako₂, stupidly said Δ.’ (Sakamoto 2019: 112)

Under the phasal ellipsis approach adopted in this paper, the unacceptability of (5c) indicates that the null ECM clause is derived by LF-copying. Based on these data, Sakamoto (2017, 2019) concluded that Japanese null clausal arguments are created by LF-copying, but not by PF-deletion.

This paper shows that an overt element can be extracted from some types of null nominalized clauses in Japanese. We argue that it is possible to extract an overt element from certain null nominalized clauses because they are derived by PF-deletion.

2. Overt extraction from null clausal arguments

As shown in the previous section, it has been observed that Japanese clausal arguments largely disallow overt extraction. However, Takahashi (2020) reports that an overt element can be extracted from certain null clausal arguments. Let us consider the examples in (6).

- (6) a. Kono biru-kara-wa₁ Taro-ga [Hanako-ga t₁ detekita no]-o mokugekisita.
 this building-from-TOP Taro-NOM Hanako-NOM came.out LN-ACC witnessed
 ‘From this building, Taro witnessed Hanako came out.’
 b. Ano biru-kara-wa₂ Ziro-ga [Hanako-ga t₂ detekita no]-o mokugekisita.
 that building-from-TOP Ziro-NOM Hanako-NOM came.out LN-ACC witnessed
 Lit. ‘From that building₂, Ziro witnessed Hanako came out t₂.’
 c. Ano biru-kara-wa₂ Ziro-ga [Δ] mokugekisita.
 that building-from-TOP Ziro-NOM witnessed
 Lit. ‘From that building₂, Ziro witnessed Δ.’ (Takahashi 2020: 67, slightly modified)

(6a) is an antecedent sentence for (6b,c). As shown in (6b), the locative PP with the topic marker *-wa* can be extracted out of the embedded clause, headed by the light noun, *no*. Importantly, (6c) shows that the PP (*ano biru-kara-wa* ‘that building-from-TOP’) can also be extracted from the null embedded clause, in contrast to the data that we have seen in the previous section. Based on this example, Takahashi (2020) assumes that Japanese null clausal arguments can be derived by PF-deletion.

We can recall that in (3c) and (5c), where an overt extraction from a null clausal argument is disallowed, the extracted phrase is an NP. Given that the extracted phrase is a PP in (6), one may consider that overt extraction out of a clausal argument might be possible when an extracted phrase is a PP. However, this is not the case. Overt PPs cannot be extracted out of a null embedded clause headed by the complementizer *to*, as shown in (7c).

- (7) Extraction out of a (null) embedded CP
 a. Kono biru-kara-wa₁ Taro-ga [CP Hanako-ga t₁ detekita to] omotta.
 this building-from-TOP Taro-NOM Hanako-NOM came.out C thought
 Lit. ‘From this building₁, Taro thought that Hanako came out t₁.’
 b. Ano biru-kara-wa₂ Ziro-ga [CP Hanako-ga t₂ detekita to] omotta.
 that building-from-TOP Ziro-NOM Hanako-NOM came.out C thought
 Lit. ‘From that building₂, Ziro thought that Hanako came out t₂.’
 c. *Ano biru-kara-wa₂ Ziro-ga [CP Δ] omotta.
 that building-from-TOP Ziro-NOM thought
 Lit. ‘From that building₂, Ziro thought Δ.’ (cf. (6))

The unacceptability of (7c) shows that the syntactic category of an extracted phrase is irrelevant to the possibility of an overt extraction out of null clausal arguments.

Takahashi (2020) also observes that when an extracted phrase is not followed by the focus particle of *-wa*, the resulting sentence is unacceptable, as in (8c).

- (8) a. Kono biru-kara₁ Taro-ga [Hanako-ga t₁ detekita no]-o mokugekisita.
 this building-from Taro-NOM Hanako-NOM came.out LN-ACC witnessed
 Lit. ‘From this building₁, Taro witnessed Hanako came out t₁.’
 b. Ano biru-kara₂ Ziro-ga [Hanako-ga t₂ detekita no]-o mokugekisita.
 that building-from Ziro-NOM Hanako-NOM came.out LN-ACC witnessed
 Lit. ‘From that building₂, Ziro witnessed Hanako came out t₂.’
 c. *Ano biru-kara₂ Ziro-ga [Δ] mokugekisita.
 that building-from Ziro-NOM witnessed
 Lit. ‘From that building₂, Ziro witnessed Δ.’ (Takahashi 2020: 67, slightly modified)

The contrast between (6c) and (8c) shows that null clausal arguments allow overt extraction from them when an extracted phrase appears with *-wa*. In this connection, note that a phrase followed by the focus particle of *-mo* can also undergo overt extraction from a null clausal argument, as shown in (9c).

(9) *Mo* ‘also’

- a. Kono biru-kara₁ Taro-ga [Hanako-ga t₁ detekita no]-o mokugekisita.
 this building-from Taro-NOM Hanako-NOM came.out LN-ACC witnessed
 Lit. ‘From this building₁, Taro witnessed Hanako came t₁.’
- b. Ano Biru-kara-mo₂ Ziro-ga [Hanako-ga t₂ detekita no]-o mokugekisita.
 that building-from-also Ziro-NOM Hanako-NOM came.out LN-ACC witnessed
 Lit. ‘From that building₂, Ziro witnessed Hanako came out t₂.’
- c. Ano biru-kara-mo₂ Ziro-ga [Δ] mokugekisita.
 that building-from-also Ziro-NOM witnessed
 Lit. ‘From that building₂, Ziro also witnessed Δ.’

In (9b), the locative of PP with *-mo* is moved out of the embedded clause. The same PP can be extracted even when an embedded clause is phonologically null, as shown in (9c).

3. More data on extraction from null clausal arguments

In this section, we introduce additional data on overt extractions out of null clausal arguments. First, we observe overt extraction from the clause headed by *tokoro*, ‘place’. As shown in (10a), the light noun of *tokoro* can combine with a clause.

(10) *Tokoro*-clauses

- a. Kono biru-kara-wa₁ Taro-ga [Hanako-ga t₁ detekita] tokoro]-o mokugekisita.
 this building-from-TOP Taro-NOM Hanako-NOM came.out tokoro-ACC witnessed
 ‘From this building, Taro witnessed Hanako came out.’
- b. Ano biru-kara-wa₁ Ziro-ga [[Hanako-ga t₁ detekita] tokoro]-o mokugekisita.
 that building-from-TOP Ziro-NOM Hanako-NOM came.out tokoro -ACC witnessed
 ‘From that building, Ziro witnessed Hanako came out.’
- c. Ano biru-kara-wa₂ Ziro-ga [Δ] mokugekisita.
 that building-from-TOP Ziro-NOM witnessed
 Lit. ‘From that building, Ziro witnessed Δ.’

(10a) is the antecedent for the sentences in (10b,c). In (10b), the PP (*ano biru-kara-wa*) is extracted from the *tokoro*-clause. The same locative PP can be overtly moved out of a null *tokoro*-clause, as shown in (10c). The acceptability of (10c) indicates that overt extraction from a null *tokoro*-clause is possible.

Moreover, overt extraction from a null clause headed by *mune* ‘content’ is also possible. Let us consider the examples in (11).

(11) *Mune*-clauses

- a. Kono biru-kara-wa₁ Taro-ga keisatu-ni [Hanako-ga t₁ detekita mune]-o
 this building-from-TOP Taro-NOM police-DAT Hanako-NOM came.out MUNE-ACC
 tsutaeta.
 told
 Lit. ‘From this building₁, Taro told a police officer that Hanako came out t₁.’
- b. Ano biru-kara-wa₂ Ziro-ga tantei-ni [Hanako-ga t₂ detekita mune]-o
 that building-from-TOP Ziro-NOM detective-DAT Hanako-NOM came.out MUNE-ACC
 tsutaeta
 told
 Lit. ‘From that building₂, Ziro told a detective that Hanako came out t₂.’
- c. Ano biru-kara-wa₂ Ziro-ga tantei-ni [Δ] tsutaeta.
 that building-from-TOP Ziro-NOM detective-DAT told
 Lit ‘From that building₂, Ziro told a detective Δ.’

The PP (*ano biru-kara-wa*) is extracted from a *mune*-clause in (11b) and its phonologically null counterpart, as in (11c). The null *mune*-clause allows overt extraction, similar to the *tokoro*-clause.

Note further that overt extraction from a null clause headed by *koto*, ‘thing’, is also possible. The relevant examples are provided in (12).

(12) *Koto*-clauses

- a. Kono biru-kara-wa₁ Taro-ga keisatu-ni [Hanako-ga t₁ detekita koto]-o tsutaeta.
 this building-from-TOP Taro-NOM police-DAT Hanako-NOM came.out koto-ACC told
 Lit ‘From this building₁, Taro told a police officer the event where Hanako came out t₁.’
- b. Ano biru-kara-wa₂ Ziro-ga tantei-ni [Hanako-ga t₂ detekita koto]-o tsutaeta
 that building-from- TOP Ziro-NOM detective-DAT Hanako- NOM came.out koto-ACC told
 Lit ‘From that building₂, Ziro told a detective the event where Hanako came out t₂.’
- c. Ano biru-kara-wa₂ Ziro-ga tantei-ni [Δ] tsutaeta.
 that building-from-TOP Ziro-NOM detective-DAT told
 Lit ‘From that building, Ziro told a detective Δ.’

As shown in (12b), a PP followed by the focus particle *-wa* can move from a *koto*-clause. Importantly, overt extraction of the same PP is possible even when the *koto*-clause is elided, as in (12c).

We also find that an overt element cannot move out of a clause headed by the content noun, *uwasa*, ‘rumor’; this is illustrated in (13).

(13) Clauses headed by the content noun *uwasa* ‘rumor’

- a. Kono biru-kara-wa₁ Taro-ga [NP [CP Hanako-ga. t₁ detekita toiu] uwasa]-o kiita.
 this building-from-TOP Taro-NOM Hanako- NOM came.out C.say rumor-ACC heard
 Lit ‘From this building₁, Taro heard the rumor that Hanako came out t₁.’
- b. Ano biru-kara-wa₁ Ziro-ga [NP [CP Hanako-ga t₁ detekita toiu] uwasa]-o kiita.
 that building-from-TOP Ziro- NOM Hanako- NOM came.out C.say rumor-ACC heard
 Lit. ‘From that building₂, Ziro heard the rumor that Hanako came out t₂.’

- c. *Ano biru-kara-wa₂ Ziro-ga [NP Δ] kiita.
 that building-from- TOP Ziro-NOM heard
 Lit. ‘From that building₂, Ziro heard Δ.’

In (13), an embedded CP containing the complementizer *toiu*, ‘say.C’, combines with the content noun *uwasa*, ‘rumor’. As shown in (13c), when the clause headed by the content NP is phonologically null, the locative PP (*ano biru-kara-wa*) cannot move out of the null clause. The data in (10), (11) and (12) show that the possibility of overt movement from a null clausal argument varies according to the type of syntactic category of the clausal argument from which the overt element moves. Our observation is summarized in Table 1. What is important here is that only Type 3 (CP + Light Nouns) allows for overt extraction from null arguments. In the next section, we will explain why Type 3 permits overt extraction from null nominalized clauses.

| | Type 1: Bare CP | Type 2: CP + NP | Type 3: CP + Light Nouns |
|-----------------------------|-----------------|-----------------|--------------------------|
| Examples | (7) | (13) | (6) (9) (10) (11) (12) |
| Overt Extraction + Ellipsis | BAD | BAD | OK |

Table 1: Summary of the data so far

One may consider that the topicalized phrase could be base-generated in the sentence initial position, rather than moved out of a null clausal argument. However, there is evidence that these phrases do undergo overt movement out of a null clausal argument. Let us consider the examples in (14). Here, the preposed phrase is followed by the postposition *-he*, ‘to’, instead of *-kara*, ‘from’, which we used in previous data.

- (14) a. Kono biru-he-wa₁ Taro-ga [Hanako-ga t₁ haitteiku no]-o mokugekisita.
 this building-to-TOP Taro-NOM Hanako-NOM entered LN -ACC witnessed
 Lit. ‘To this building₁, Taro witnessed Hanako entered t₁.’
 b. Ano biru-he-wa₂ Ziro-ga [Hanako-ga t₂ haitteiku no]-o mokugekisita.
 that building-to- TOP Ziro-NOM Hanako-NOM entered LN -ACC witnessed
 Lit. ‘To that building, Ziro witnessed Hanako entered.’
 c. Ano biru-he-wa₂ Ziro-ga [Δ] mokugekisita.
 that building-to- TOP Ziro-NOM witnessed
 Lit. ‘To that building₂, Ziro witnessed Δ.’

(14a) is the antecedent to (14b,c). What is important here is that the PP (*ano biru-he-wa*, ‘that building-to-TOP’) cannot function as an adjunct of the matrix verb *mokugekisita*, ‘witnessed’, as in (15).

- (15) *Ano biru-he-wa Ziro-ga mokugekisita.
 that building-to-TOP Ziro-NOM witnessed
 Lit. ‘To that building, Ziro witnessed.’

The unacceptability of (15) shows that the topicalized phrase (*ano biru-he-wa*) in (14c) cannot be an adjunct of the matrix verb. This, in turn, indicates that the topicalized phrase in (14c)

should be base-generated in the embedded clause, and then moved to the sentence initial position. The same pattern should also hold for the topicalized phrases in the previous examples.

There is another piece of supporting evidence that the data discussed in the present paper involve extraction out of a null embedded clause. The noun *mune*, ‘content’, can be used as an anaphoric noun (e.g., *sono mune*, ‘that content’ and *onazi mune*, ‘the same content’), without combining with an overt clause. As shown in (16b,c), when *mune* is used as a noun, a locative PP cannot appear in the sentence initial position, as opposed to the examples in (11).

- (16) a. *Kono biru-kara-wa₁ Taro-ga keisatsu-ni [Hanako-ga t₁ detekita mune]-o*
 this building-from-TOP Taro-NOM police-DAT Hanako-NOM came.out MUNE-ACC
tsutaeta.
 told
 Lit ‘From this building₁, Taro told a police officer the event where Hanako came out t₁.’
- b. **Ano biru-kara-wa Ziro-ga tantei-ni [sono mune]-o tsutaeta.*
 that building-from-TOP Ziro-NOM detective-DAT its mune-ACC told
 Lit ‘From that building, Ziro told a detective its event.’
- c. **Ano biru-kara-wa Ziro-ga tantei-ni [onazi mune]-o tsutaeta.*
 that building-from-TOP Ziro-NOM detective-DAT the.same mune-ACC told
 Lit ‘From that building, Ziro told a detective the same event.’ (p.c. Yuto Hirayama)

The contrast between (11) and (16b, c) indicates that the topicalized locative phrases in (11) are not base-generated in the sentence initial position. If a topicalized phrase could appear in the sentence initial position without involving movement, (16b, c) should also be acceptable; this would be contrary to the fact. Based on these examples, we assume that in the extraction data discussed thus far (especially (10), (11), and (12)), the topicalized phrases are extracted out of a null clausal argument by movement, rather than base-generation.

4. Analysis

4.1 Overt extraction and ellipsis

In the previous section, we have seen that an overt element can be extracted from some null clausal arguments. However, we have also observed that null CP arguments (Type 1 in Table 1) and null clauses with a content noun (Type 2 in Table 1) disallow for overt extraction. To explain the contrasts in the possibility of overt extraction, we propose that null clausal arguments that allow for overt extraction are derived by PF-deletion, whereas null clausal arguments that disallow for overt extraction are created via LF-copying.

Bošković (2014) claims that ellipsis can target either a phase or phrasal complement. In (17), the phase head (Ph) takes the YP as its complement (we use the X-bar notation in (18) for expository purposes only).

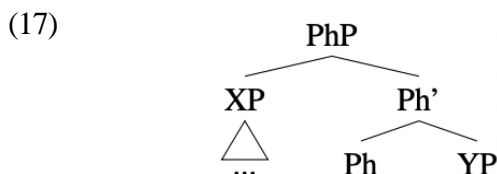

In (17), the entire phase (i.e., PhP) and phasal complement (i.e., YP) can be a target of the

ellipsis according to Bošković (2014). Following Bošković’s analysis, Sakamoto (2019) proposes the generalization provided in (18).

- (18) Phasal ellipsis (e.g., argument ellipsis) is implemented by LF copying, while phasal complement ellipsis (e.g., sluicing) is implemented by PF deletion. (Sakamoto 2019:126)

Under Bošković’s (2014) phase theory, we can make sense of the generalization in (18). Phases are visible for syntactic operations like LF-copying. It seems reasonable to assume that when a phase undergoes ellipsis, the relevant ellipsis operation is implemented by LF-copying. On the other hand, a phasal complement is assumed to be a target of Spell-Out, which transfers information in narrow syntax to the PF-interface (Chomsky 1995, 2000, 2001). It is thus not surprising that phasal complements are targeted by a PF-related ellipsis, such as PF-deletion. PF-deletion can be regarded as a phonological deletion of a spell-out domain (i.e., a phasal complement): if a spelled-out constituent is not pronounced, the constituent is considered to be elided by PF-deletion.¹

Following the phase-based theory of ellipsis, we argue that the data summarized in Table 1 can be explained if we assume that the clausal arguments discussed thus far have different structures. First, let us consider overt extraction out of null CP arguments. The relevant examples are repeated here as (19).

- (19) Extraction out of a (null) embedded CP

- a. Kono biru-kara-wa₁ Taro-ga [_{CP} Hanako-ga t₁ detekita to] omotta.
 this building-from-TOP Taro-NOM Hanako-NOM came.out C thought
 Lit. ‘From this building₁, Taro thought that Hanako would come out t₁.’
- b. Ano biru-kara-wa₂ Ziro-ga [_{CP} Hanako-ga t₂ detekita to] omotta.
 that building-from-TOP Ziro-NOM Hanako-NOM came.out C thought
 Lit. ‘From that building₂, Ziro thought that Hanako would come out t₂.’
- c. *Ano biru-kara-wa₂ Ziro-ga [_{CP} Δ] omotta.
 that building-from-TOP Ziro-NOM thought
 Lit. ‘From that building₂, Ziro thought Δ.’

Following standard assumptions, we assume that bare CP arguments have the structure in (20).

- (20) Type 1: Bare CP arguments
 [_{VP} [CP ...YP-from ... C] V] (CP-phase, LF-copying)

Under the phase-based theory of ellipsis, a null clausal argument is derived by LF-copying of the CP-phase (i.e., the shaded part in (20)). An overt element cannot be extracted out of the null CP argument that is generated by LF-copying because the null clausal argument is copied onto the structure at LF after overt extraction occurs. Thus, the sentence in (19c) is unacceptable.

Next, let us consider clauses with the content noun of *uwasa*, ‘rumor’. The relevant examples are repeated here as (21).

¹ In the current paper, we assume that only phasal complements can undergo Spell-Out, and hence, be a target of PF-deletion. For different assumptions regarding the size of the Spell-Out domain, see Bošković (2016), Saito (2017), and the references therein.

(21) Clauses headed by the content noun *uwasa* ‘rumor’

- a. Kono biru-kara-wa₁ Taro-ga [NP [CP Hanako-ga. t₁ detekita toiu] uwasa]-o kiita.
 this building-from-TOP Taro-NOM Hanako-NOM came.out C.say rumor-ACC heard
 Lit ‘From this building₁, Taro heard the rumor that Hanako came out t₁.’
- b. Ano biru-kara-wa₁ Ziro-ga [NP [CP Hanako-ga t₁ detekita toiu] uwasa]-o kiita.
 that building-from-TOP Ziro-NOM Hanako-NOM came.out C.say rumor-ACC heard
 Lit. ‘From that building₂, Ziro heard the rumor that Hanako came out t₂.’
- c. *Ano biru-kara-wa₂ Ziro-ga [NP Δ] kiita.
 that building-from- TOP Ziro-NOM heard
 Lit. ‘From that building₂, Ziro heard Δ.’

Clauses with a content noun have been analyzed as involving a complementation structure, as in (22a) (Kuno 1973, Nakau 1973), or an adjunction structure, as in (22b).²

(22) Type 2: CP + NP

- a. CP + NP (Complementation Structure)
 [VP [NP [CP ... YP-from ... toiu_C] [N uwasa]] V] (NP-phase, LF-copying)
- b. CP + NP (Adjunction Structure)
 [VP [NP [CP ... YP-from ... toiu_C] [NP uwasa]] V] (NP-phase, LF-copying)

Following Bošković (2014), we assume that the highest projection in each nominal domain or clausal domain is regarded as a phase. This means that the topmost NP is a phase in (22a,b). To derive the elided part of the sentence in (21c), the whole NP must be a target of the relevant ellipsis operation. Under the current phrase-based analysis of ellipsis, the ellipsis of the NP (i.e., a phase) is implemented by LF-copying, rather than PF-deletion. It is then predicted that overt extraction out of a null content clause is not allowed.

Thus far, we have focused on null clausal arguments that disallow for overt extraction. As discussed in Section 2, we found that clausal arguments headed by a light noun allow for overt extraction. We propose that clausal arguments with a light noun contain the structure provided in (23).

(23) Type 3: CP + Light Nouns

- [VP [NP [VP [CP/IP ... YP-from ...] √LN] n] V] (the complement of the n phase, PF-deletion)

Building on Kratzer (2006) and Moulton (2014), we assume that some clause-taking nominals can combine with a clausal argument before they are nominalized by the nominalizer head, *n*. In (23), light nouns such as *no*, *tokoro*, *mune*, and *koto* are analyzed as roots that take a clausal argument. The clause-taking root is then nominalized by the nominalizer head, *n*. Following Arad (2003), we assume that the nominalizer *n* is a phase head. In (23), the clause-taking light noun occurs in the complement of the nominalizer (i.e., the phase head). The phasal complement can thus be a target of PF-deletion under the phase-theory of ellipsis. Overt elements can be extracted out of the elided part in (23) before PF-deletion takes place. It is therefore predicted that the examples in (6), (9), (10), (11), and (12) are all acceptable.

From this connection, it is worth noting that the possibility of overt extraction does not

² In this paper, we assume that *toiu* is a complementizer that arises from the complementizer *to* and the verb *iu*, ‘say’, via grammaticalization. See Saito (2021) for a detailed analysis into the relevant grammaticalization process.

depend on the size of a target null clause. As shown in (24a), the *mune*-clause can include the overt complementizer *toiu*, ‘C.say’. Importantly, the clausal argument headed by the light noun, *mune*, still allows for overt extraction, despite the presence of the overt complementizer, as in (24b).

- (24) a. Kono biru-kara-wa₁ Taro-ga keisatsu-ni [_{NP} [_{CP} Hanako-ga. t₁ detekita toiu]
 this building-from- TOP Taro-NOM police-to Hanako-NOM came.out C.say
mune]-o tsutaeta.
 LN.content- ACC told
 Lit. ‘From this building₁, Taro told a police office that Hanako came out t₁.’
- b. Ano biru-kara-wa₂ Ziro-ga tantei-ni [Δ] tsutaeta.
 that building-from- TOP Ziro- NOM detective-to told
 Lit. ‘From that building₂, Ziro told a detective Δ.’ (cf. (11))

We can explain the acceptability of (24b) without any additional stipulations. There is an ongoing debate regarding the size of prenominal clauses (Murasugi 1991, 2000, Miyamoto 2010, a.o.). Our present analysis is not affected by this debate. The presence of the complementizer, *toiu* in (24), may indicate that the clausal argument is a CP. However, our analysis still predicts that the null *mune*-clause allows overt extraction if the elided clause combines with the light noun, *mune*, before the nominalizer head is introduced into the structure.

4.2 Internally-Headed Relative Clauses

Thus far, we have argued that clauses headed by a light noun can allow for overt extraction because these clausal arguments occur in the complement of the phase head (i.e., the nominalizer *n*). In this respect, it should be noted that the complementation structure given in (23) is available only with light nouns, such as *no*, *tokoro*, *mune*, and *koto*. It is also important to note that some light nouns can appear in structures other than the one in (23). For example, the light *no* and *tokoro* can function as the head noun of the so-called Internally-Headed Relative Clauses (IHRCs), as shown in (25a, b).

- (25) a. Taro-ga [[doroboo-ga kono biru-kara detekita] no]-o tsukamaeta.
 Taro-NOM thief-NOM this building-from came.out LN_{thing}-ACC caught
 ‘Taro caught a thief that came out from this building.’ (IHRC)
- b. Taro-ga [[doroboo-ga kono biru-kara detekita] tokoro]-o tsukamaeta.
 Taro-NOM thief-NOM this building-from came.out LN_{place}-ACC caught
 ‘Taro caught a thief that came out from this building.’ (IHRC)
- c. Taro-ga [[kono biru-kara detekita] doroboo]-o tsukamaeta.
 Taro-NOM this building-from came.out thief-ACC caught
 ‘Taro caught a thief that came out from this building.’ (Relative Clause)

The clausal arguments in (25a, b) have a meaning that is similar to the one expressed by the typical relative clause in (25c). The crucial difference between IHRC and typical relative clauses is that the head noun (i.e. *doroboo* ‘thief’) remains in the clause-internal position in the former case. Importantly, when the light noun *no* and *tokoro* appear in IHRCs, the resulting clausal arguments do not allow for overt extraction, as shown in (26) and (27).

- (26) a. Kono biru-kara-wa₁ Taro-ga [doroboo-ga t₁ detekita no]-o tsukamaeta.
 this building-from-TOP Taro-NOM thief-nom came.out LN-ACC caught
 Lit. ‘From this building₁, Taro caught a thief that came out t₁.’
 b. *Ano biru-kara-wa Ziro-ga [Δ] tsukamaeta.
 that building-from- TOP Ziro-nom caught
 Lit. ‘From that building, Ziro caught Δ.’ (cf. (6))

- (27) a. Kono biru-kara-wa₁ Taro-ga [doroboo-ga t₁ detekita tokoro]-o tsukamaeta.
 this building-from- TOP Taro-NOM thief-nom came.out LN.place-ACC caught
 Lit. ‘From this building₁, Taro caught a thief that came out t₁.’
 b. *Ano biru-kara-wa Ziro-ga [Δ] tsukamaeta.
 that building-from- TOP Ziro- NOM caught
 Lit. ‘From that building, Ziro caught Δ.’

The unacceptability of (26b) and (27b) show that the locative PP (*ano biru-kara-wa*, ‘that building-from-top’) cannot be extracted out of the null IHRCs.

Since the IHRCs in (26) and (27) are headed by the light noun *no* and *tokoro*, one may consider that these examples may be problematic for our proposed analysis. However, our current analysis can capture the unacceptability of (26b) and (27b). Japanese IHRCs have received much attention in the literature (Kuroda (1974, 1992, 1999), Uchibori (1991), Mihara (1994) and Hoshi (1995), Shimoyama (1999), Watanabe (2004) a.o.). Aside from these details, the previous studies can be classified into two approaches: one is the external-head analysis given in (28a) and the other is the nominalization analysis represented in (28b).

- (28) a. [VP [NP [... Head ... YP-from ... {nonNML/ tokoronNML}] [NP [e]]] V] (LF-copying)
 b. [VP [NP ... Head ... YP-from ... {nonNML/ tokoronNML}] V] (LF-copying)

It is important to note that in both analyses represented in (28), *no* and *tokoro* are analyzed as a nominalizer head. It has been independently observed that certain nominalizers result from light nouns due to grammaticalization (see Jhang 1994 for Korean *kes*, and Simpson 2008 for a similar grammaticalization process in Burmese). Based on this, we assume that when *no* and *tokoro* appear in IHRCs, they function as a nominalizer head, rather than light nouns.

In (28a), the clause combines with a phonologically null head (i.e., [e]). In this structure, a null clausal argument must be derived by LF-copying under the phase-based analysis of ellipsis. This is because both the nominalized clause and top-most clause-taking NP in (28a) are regarded as a phase under the current assumption (recall that we assume, following Bošković (2014), that the highest projection in each nominal domain or a clausal domain is regarded as a phase). Similarly, the ellipsis of the nominalized clause in (28b) should be implemented by LF-copying because the target constituent is a phase here, too. The null IHRCs in (26b) and (27b) must be derived by LF-copying, and hence disallow overt extraction, as in the examples of (7) and (13).

5. Summary

In this paper, we elaborated on Takahashi’s (2020) observation about overt extraction out of null clausal arguments, showing that clausal arguments headed by a light noun generally allow for overt extraction. We proposed that light nouns such as *no*, *koto*, *tokoro*, and *mune* combine

with a clausal element before the nominalizer head, *n*, is introduced into the derivation. The proposed analysis can explain the patterns of overt extraction out of null clausal arguments in tandem with the phase-based analysis of ellipsis, which was proposed by Bošković (2014) and Sakamoto (2019).

References

- Bošković, Željko. 2014. Now I'm a phase, now I'm not a phase: On the variability of phases with extraction and ellipsis. *Linguistic Inquiry* 45. 27–89.
- Bošković, Željko. 2016. What is sent to spell-out is phases, not phasal complements. *Linguistica* 56(1). 25–66.
- Hankamer, Jorge & Ivan Sag. 1976. Deep and surface anaphora. *Linguistic Inquiry* 7(3). 391–428.
- Hoshi, Koji. 1995. Structural and interpretive aspects of head-internal and head-external relative clauses: University of Rochester.
- Jhang, Sea-Eun. 1994. Headed Nominalizations in Korean: Relative Clauses, Clefts, and Comparatives. Ph.D. dissertation, Simon Fraser University
- Kasai, Hironobu. 2014. On the nature of null clausal complements in Japanese. *Syntax* 17. 168–188.
- Kim, Min-Joo. 2009. E-type anaphora and three types of kes-construction in Korean. *Natural Language and Linguistic Theory* 27. 345–377.
- Kuno, Susumu. 1973. *The structure of the Japanese language*. Cambridge, MA: MIT Press.
- Kuroda, S.-Y. 1974. Pivot-independent relativization in Japanese I. *Papers in Japanese Linguistics* 3. 59–93.
- Kuroda, S.-Y. 1992. Pivot-independent relativization in Japanese. In S.-Y. Kuroda (ed.), *Japanes syntax and semantics*, 114–174. Dordrecht: Kluwer Academic Publishers.
- Kuroda, S.-Y. 1999. Syubunaizai kankeisetu [Head-internal relative clauses]. In S.-Y. Kuroda & Masaru Nakamura (eds.), *Kotoba no kaku to syuuen*. 27–103. Tokyo: Kurosio Publishers.
- Merchant, Jason. 2013. Diagnosing ellipsis. In *Diagnosing syntax*, ed. by Lisa L. Cheng and Norbert Corver, 537–542. Oxford: Oxford University Press.
- Mihara, Ken-ichi. 1994. *Nihongo no togo koozoo* [Syntactic structures of Japanese]. Tokyo: Shohakusha.
- Miyamoto, Yoichi. 2010. On Chinese and Japanese relative clauses and NP-ellipsis. *Nanzan Linguistics* 6. 13–46.
- Moulton, Keir. 2014. Simple event nominalizations: Roots and their interpretation. In I. Paul (ed.), *Cross-linguistic investigations of nominalization patterns*, 119–144. Cambridge: John Benjamins.
- Murasugi, Keiko. 1991. *Noun phrases in Japanese and English*, Ph.D dissertation, University of Connecticut.
- Murasugi, Keiko. 2000. An antisymmetry analysis of Japanese relative clauses. In Artemis Alexiandou, Paul Law, Andre Meinunger & Chris Wilder (eds.), *The syntax of relative clauses*, 231–263. Amsterdam: John Benjamins.
- Nakau, Minoru. 1973. *Sentential complementation in Japanese*. Tokyo: Kaitakusha.
- Saito, Hiroaki. 2021. Grammatization as decategorization. *Journal of Historical Syntax* 5. 1–24.
- Saito, Mamoru. 2007. Notes on East Asian argument ellipsis. *Language Research* 43. 203–227.
- Saito, Mamoru. 2017. A note on transfer domain. *Nanzan Linguistics* 12: 61–69
- Sakamoto, Yuta. 2017. *Escape from silent syntax*. Ph.D dissertation, University of Connecticut, Storrs.
- Sakamoto, Yuta. 2019. Overtly empty but covertly complex. *Linguistic Inquiry* 50. 105–136.
- Shimoyama, Junko. 1999. Internally headed relative clauses in Japanese and E-type anaphora. *Journal of East Asian Linguistics* 8(2). 147–182.

- Simpson, Andrew. 2008. The grammaticalization of clausal nominalizers in Burmese. In María López-Couso and Elena Seoane (eds.), *Rethinking Grammaticalization: New perspectives*, 265–288.
- Takahashi, Daiko. 2020. Derivational argument ellipsis. *The Linguistic Review* 37. 47–74.
- Takita, Kensuke. 2010. Cyclic linearization and constraints on movement and ellipsis. Doctoral dissertation, Nanzan University.
- Tanaka, Hidekazu. 2008. Clausal complement ellipsis. Ms., University of York.
- Uchibori, Asako. 1991. Head-internal relatives in Japanese. In *The proceedings of KLS 11*, 81–90. Kansai Linguistic Society.
- Watanabe, Akira. 2004. Parametrization of quantificational determiners and head-internal relatives. *Language and Linguistics* 5(1). 59–97. Taipei: Academia Sinica.

Deriving Wordhood Without Word: *Wh*-Compound Questions in Japanese and Renumeration

Yosuke Sato, Hisako Ikawa

Tsuda University, Risho University

1. Introduction

One of the central issues that have been vigorously debated in the literature on the syntax-morphology interface is how words and their formation rules relate to derivational rules responsible for larger objects such as phrases and sentences in the syntax.¹ There are two prominent positions on this issue within the generative framework. One is the so-called Lexicalist Hypothesis (hereafter, LH) (Chomsky 1970; Di Sciullo and Williams 1987; Anderson 1992; Bresnan and Mchombo 1995, among many others). This hypothesis holds that words are formed in the Lexicon to serve as unanalyzable terminal elements for the purposes of syntax. This position thus gives rise to the so-called Lexical Integrity Principle, namely, that syntax cannot have access to the internal structure or derivational history of words, which enter syntax as atomic operands. The competing approach to the syntax-morphology interface question stated above is upheld by the Distributed Morphology (hereafter, DM) (Halle and Marantz 1993; Marantz 1997; Harley and Noyer 1999; Embick and Noyer 2007; see also the so-called Nanosyntactic approach to word formation, e.g., Taraldsen 2019). The DM approach hypothesizes that all complex objects, including ‘words’, are assembled through the same generative system in the syntax so principles composing ‘words’ are identical to those composing larger objects like phrases and sentences. Accordingly, the DM proposes that there is no principled distinction to be drawn between “word” and phrase; it is not only superfluous but also undefinable since the theory postulates no dedicated module for word formation such as the Lexicon.

Against this background, the purpose of this paper is to investigate the syntactic and morphological structures of *wh*-compound questions in Japanese (Kageyama 1993; Harada 2014; Kimura and Narita 2016, 2017, 2021) to adjudicate between the two competing approaches to the syntax-morphology interface regarding the notion of word and the locus of word formation in the grammatical architecture. We will show that this type of question creates an ordering paradox for any version of the lexicalist theory and that it can be resolved under the alternative DM-based theory dispensing with the pre-syntactic Lexicon. In so doing, we will develop a purely syntactic analysis of *wh*-compound questions which capitalizes on the proposal that certain sub-chunks of syntactic derivations can be spelled-out early and renumerated into the current syntactic workspace as a derived terminal item (Uriagereka 1999; Johnson 2004; Sato 2010; Harley 2011).

This paper is organized as follows. We will start in section 2 by providing three pieces of evidence supporting the word status of *wh*-compounds in Japanese: sequential voicing, the

¹ We thank Hee-Don Ahn, Mike Barrie, Andy Barss, Andrew Carnie, Anna Maria Di Sciullo, Yoshi Dobashi, Takuya Goro, Heidi Harley, Simin Karimi, Hiroko Kimura, Richard Larson, Seunghun Lee, Tommy Tsz-Ming Lee, Akiko Nagano, Taichi Nakamura, Hiroki Narita, Hiro Oda, Yoshiki Ogawa, Satoshi Oku, Hajime Ono, Myung Kwan Park, Jeff Punske, Ken Takita, Juan Uriagereka, Martina Wiltschko and Dwi Hesti Yuliani for comments and discussions. All errors are our own. The project reported here is supported by JSPS KAKENHI Grant Number 19K00560 (Yosuke Sato).

Compound Accent Rule and lexical integrity effects. This is followed by two types of arguments – partial fragment answers to *wh*-compound questions and islands/intervention effects/additional *wh*-effects – demonstrating that syntax has access to the internal structure of *wh*-compounds. These two arguments lead us to conclude that the very existence of *wh*-compound questions, with various properties transcending the syntax-lexicon border, poses an ordering paradox for any analysis couched within the lexicalist model. In section 3, we will develop our analysis of this type of question modeled after a DM-based analysis of phrasal compounds proposed by Sato (2010) and Harley (2011). We will show how it derives syntactic sensitivity of *wh*-compound questions through regular combinatorial procedures in the syntactic derivation while at the same time deriving their lexical integrity effects through early spell-out and renumeration. Section 4 is the conclusion.

2. *Wh*-Compound Questions as an Ordering Paradox for the Lexicalist Hypothesis

Wh-compound questions in Japanese are illustrated in (1A).²

- (1) Q: Kimi-wa kinoo nani-gayu-o tabeta-no?
 you-TOP yesterday what-porridge-ACC ate-Q
 ‘What-porridge did you eat yesterday?’
 A: Tamago-gayu desu.
 egg-porridge COP
 ‘(It was) an egg porridge.’

In (1Q), *nani-gayu* ‘what-porridge’ consists of the *wh*-word *nani* ‘what’ and the head noun *kayu* ‘porridge’. Note that this expression signals a genuine *wh*-question, for it must be answered with a particular value to the *wh*-word such as *tamago-gayu* ‘egg-porridge’. Examples in (2Q) and (3Q) are two further examples of *wh*-compound questions in Japanese.³ Note that the example in (3Q) instantiates a multiple *wh*-question employing the *wh*-compound question strategy.

- (2) Q: Omae-wa nani-iri-onigiri-ga suki-nan?
 you-TOP what-containing-rice.ball-NOM like-Q
 ‘Lit. You like what-containing rice balls?’
 A: Zibun-wa suziko-iri-onigiri-ga suki-ssu-ne.
 self-TOP salted.salmon.roe-containing-rice.ball-NOM like-POL-SFP
 ‘Lit. I like salted salmon roe-containing rice balls.’
- (3) Q: Oto-tyan-tesa Tsudajuku-daigaku nani-gakubu nani-gakka
 Oto-TIT-TOP Tsuda-University what-faculty what-department
dare-zemi-kiboo-nan-da-kke?
 who-seminar-wishing-Q-COP-SFP
 ‘Lit. Oto, you wish to get enrolled for whose-seminar of what-department from what-faculty at Tsuda University?’

² The glosses in this paper follow the Leipzig Glossing Rules. Below is the list of additional abbreviations used in the data section of the paper: LINK, linker; POL, politeness marker; SFP, sentence-final particle; TIT, title.

³ See Namiki (2003) for various arguments for the compound status of *X-iri Y* expressions.

- A: Gakugei-gakubu eigoibun-gakka Yosuke-zemi-da-yo.
 arts-faculty English.language.and.literature-department Yosuke-seminar-COP-SFP
 ‘Lit. It is Yosuke-seminar of the Department of English Language and Literature of the
 Faculty of Arts (at Tsuda University).’

Below is the list of possible combinations of *wh*-words, presented by Harada (2014), which form input for *wh*-compounds in Japanese, together with some illustrative examples in each case.

- (4) a. *nani* ‘what’ → *nani-nabe* ‘what-hot.pot’, *nani-kankei* ‘what-relation’
 b. *dare* ‘who’ → *dare-toku* ‘who-benefit’, *dare-mati* ‘who-waiting’
 c. *doko* ‘where’ → *doko-zyoohoo* ‘where-information’, *doko-keeyu* ‘where-through’
 (Harada 2014:25)

2.1 Three Pieces of Evidence for the Word Status of *Wh*-Compound Questions in Japanese

There are three pieces of evidence showing that the *wh*-expressions in (1–3) form compounds. First, it is well-known that in Japanese, sequential voicing, or *rendaku*, voices the initial obstruent of the second member of a compound. This morphophonological process is illustrated in (5a, b).

- (5) a. *ame* + *kasa* → *amagasa*
 ‘rain’ ‘umbrella’ ‘umbrella’
 b. *neko* + *sita* → *nekozita*
 ‘cat’ ‘tongue’ ‘sensitive tongue’
 (Kubozono 1995:58)

In (5a), the initial consonant of the noun *kasa* ‘umbrella’, [k], changes to its voiced counterpart, [g], when the noun is compounded with another noun *ame* ‘rain’ to yield *amagasa* ‘umbrella’. The same process accounts for the change from [s] to [z] in *nekozita* ‘sensitive tongue’ in (5b), which results from the compounding of two independent nouns, *neko* ‘cat’ and *sita* ‘tongue’. Importantly for our present purposes, what we have thus far dubbed *wh*-compounds may undergo sequential voicing, as shown in (6a, b). Here, the initial consonant of the second nouns (i.e., *karami* ‘related’ and *kayu* ‘porridge’), [k], changes to its voiced counterpart, [g], when they are compounded with *wh*-words (i.e., *doko* ‘where’ and *nani* ‘what’, respectively).

- (6) a. *doko* + *karami* → *dokogarami*
 ‘where’ ‘related’ ‘related to where’
 b. *nani* + *kayu* → *nanigayu*
 ‘what’ ‘porridge’ ‘what-porridge’
 ((6a) from Harada 2014:27)

Second, *wh*-compounds are subject to the same accent rule as other bona fide compounds in Japanese. Kubozono (1995) observes that unlike phrases, compounds are subject to the Compound Accent Rule defined in (7).⁴

⁴ This is our English translation of the Compound Accent Rule originally defined in Japanese by Kubozono.

(7) The Compound Accent Rule (Kubozono 1995:58)

The Compound Accent Rule destroys the lexical accent structures of the constituent parts of a compound and integrates the two accentual phrases into a single accent phrase.

Let us see how this rule works, using (8a, b) as illustrative examples.

- (8) a. *sarariiman-no* + *sintoo* → *sarariiman-no sintoo* (phrasal accent)
 ‘office.worker-GEN’ ‘new.party’ ‘new party for office workers’
 b. *sarariiman* + *sintoo* → *sarariimansintoo* (compound accent)
 ‘office.worker’ ‘new.party’ ‘office workers’ new party’
 (Kubozono 1995:59)

In (8a), we have the nominal phrase *sarariiman-no sintoo* ‘new party for office workers’, where its phrasehood is diagnosed by the presence of the genitive marker *no*. The nominal phrase has phrasal accent in the sense that the lexical accent nucleuses of the two input nouns are retained in the phrase. In (8b), we have instead *sarariimansintoo* ‘office workers’ new party’ without the genitive marker. This expression exhibits compound accent in the sense that it has only one accent nucleus even though the input noun phrases themselves are each associated with an independent lexical accent, suggestive of the application of the Compound Accent Rule in (7). With the forgoing accentual difference in mind, consider now examples in (9a, b).

- (9) a. *dòko-kara-no* + *zyòohoo* → *dòko-kara-no zyòohoo* (phrasal accent)
 ‘where-from-GEN’ ‘information’ where-from-GEN information
 b. *dòko* + *zyòohoo* → *dokoozyòohoo* (compound accent)
 ‘where’ ‘information’ ‘where-information’

(9a) illustrates the phrasal accent pattern of the phrase *dòko-kara-no zyòohoo* ‘information from where’, which truthfully retains two original accent nucleuses from the input noun phrases *dòko-kara-no* ‘where-from-GEN’ and *zyòohoo* ‘information’. This phrasal accent pattern is to be contrasted with the compound accent pattern exhibited by *dokoozyòohoo* ‘where-information’, which behaves on a par with (8b), not with (8a), with respect to the accent rule: it only has one accent nucleus. This contrast, therefore, lends further support to our position that what we have deemed *wh*-compounds thus far indeed constituent compounds (and hence word-level units).

Finally, what we have termed *wh*-compounds so far exhibit so-called lexical integrity effects. One manifestation of the lexical integrity effects is that compounds do not accept modification into any component part thereof, unlike phrases. To illustrate, consider examples in (10a, b).

- (10) a. *aozyasin*(compound) → * *hanbun aozyasin* ‘a half blueprint’
 ‘blueprint’ ‘half’ blueprint’
 b. *aoi* + *syasin* (phrase) → *hanbun aoi syasin* ‘a half blue photo’
 blue photo ‘half’ blue photo

In (10a), we have the compound *aozyasin* ‘blueprint’ which consists of *aoi* ‘blue’ and *syasin* ‘photo’; its compoundhood is confirmed by the application of sequential voicing, which

changes [s] to [z]. The ungrammaticality of **hanbun aozyasin* ‘a half blueprint’ shows that *hanbun* ‘half’ cannot modify the adjectival member of the compound. This effect is not observed with phrases, however, as shown by the grammaticality of *hanbun aoi syasin* ‘a half blue photo’ in (10b), where the same adverb can modify part of the noun phrase. This is thus one manifestation of the lexical integrity effect, namely, that compounds are impenetrable by any syntactic operations such as phrase-level modification. Keeping this effect in mind, the ungrammaticality of (11a–c) shows that *wh*-compounds such as *dare-toku* ‘who-benefit’, *nani-nabe* ‘what-hot.pot’ and *doko-zyoohoo* ‘where-information’ indeed exhibit lexical integrity, for no word may intervene between the first and second members of the relevant *wh*-compounds.⁵

- (11) a. dare-(***tyoo**)-toku
 who-exceedingly-benefit
 ‘intended: benefit-who-exceedingly’
- c. nani-(***oo**)-nabe
 what-big-hot.pot
 ‘intended: what-big.hotpot’
- c. doko-(***ura**)-zyoohoo
 where-secret-information
 ‘intended: what-secret.information’ (Harada 2014:26)

It is clear from the above that the *wh*-N expressions in the examples thus far constitute a subspecies of genuine compounds in Japanese and hence a word within the lexicalist theory of the syntax-morphology interface, according to which compounds are formed in the pre-syntactic lexicon. In the next subsection, however, we will introduce data pointing to the opposite conclusion that *wh*-compounds allow syntactic operations to peek into their internal structure.

2.2 Three Pieces of Evidence for Syntactic Access to the Internal Structure of *Wh*-Compounds

We will now provide data showing that the internal structure of *wh*-compounds is actually accessible to syntactic processes and conditions, contrary to the conclusion reached in section 2.1. First, direct evidence for syntactic access to the internal structure of a *wh*-compound is available from Kimura and Narita’s (2016, 2017, 2021) observation. Kimura and Narita observe that a *wh*-compound yields a regular *wh*-interpretation for its *wh*-constituent part alone embedded within. This observation is evidenced by the availability of partial answers to such compound questions as illustrated in (12A) and (13A).

- (12) Q: Keisatu-wa nani-gorosi-no hannin-o tukamaeta-no?
 police-TOP what-slaughter-LINK culprit-ACC caught-Q
 ‘lit. [The [what-slaughter] culprit] did the police catch?’
- A: Noraneko (da/desu).
 stray.cat COP/COP-POL
 ‘Stray cat(s)’ (Kimura and Narita 2017:142)

⁵ We will come back to a more in-depth examination of the unacceptability status of (11a–c) in section 3.2.

- (13) Q: Kimi-wa nani-nabe-o kinoo tabeta-no?
 you-TOP what-hot.pot-ACC yesterday ate-Q
 ‘lit. You ate [what-hot.pot] yesterday?’
 A: Kimuti-(nabe) da-yo.
 Kimchi-hot.pot COP-SFP
 ‘It was Kimchi hotpot (that I ate yesterday).’

According to Kimura and Narita (2017), the fragment answer in (12A) is derived through in-situ scattered non-constituent deletion, according to which everything undergoes deletion except for the focused constituent staying in its thematic position, as schematically depicted in (14).

- (14) [~~Keisatu-wa~~ [[[_{NI} NORANEKO]-[_{N2} gorosi]-no ~~hanmin~~]-o ~~tukamaeta~~]-no] da/desu].
 police-TOP stray.cat-slaughter-LINK culprit-ACC caught-Q COMP COP/COP-POL
 ‘Lit. It is that the police caught the [stray cat-slaughter culprit].’ (Kimura and Narita 2017:148)

To the extent that Kimura and Narita’s analysis is tenable, the grammaticality of the partial answer pattern shows that whatever syntactic process is responsible for a *wh*-question construal has access to the internal structure of *wh*-compounds so that it may pick its internal *wh*-word. (13A) illustrates the same point. The *wh*-compound in the set-up question in (13Q) is *nani-nabe* ‘what-hot.pot’, but one may answer the question by giving a value to the *wh*-constituent alone in addition to repeating the *wh*-part plus the head noun, as indicated in (13A). This finding further supports our conclusion that *wh*-compounds are penetrable by syntactic processes such as *wh*-construal.

We will now turn to the second type of arguments to demonstrate syntactic accessibility to *wh*-compound questions. We will demonstrate that *wh*-compound questions exhibit movement restrictions characterizing genuine *wh*-questions, such as island effects, intervention effects (Hoji 1985; Beck 1996; Beck and Kim 1997; Tomioka 2007, among others) and additional *wh*-effects (Watanabe 1992; Saito 1994). Since this indicates that the formation of *wh*-compound questions follows the same syntactic rules as that of regular *wh*-questions, it lends further credence to our conclusion that this type of question allows syntactic derivation to peek into its internal structure.

Let us start with island effects, using (15a, b) as illustrative examples.

- (15) *Wh*-island effects
 a. * Kimi-wa_[CP(=island)] kono-ken-de dare-ga tokusita-no-ka] siritagatteiru-no?
 you-TOP this-matter-in who-NOM benefited-COMP-Q want.to.know-Q
 ‘*Who_i do you want to know whether *t_i* benefited in this matter?’
 b. * Kimi-wa_[CP(=island)] kono-ken-ga dare-toku-na-no-ka] siritagatteiru-no?
 you-TOP this-matter-NOM who-benefit-COP-COMP-Q want.to.know-Q
 ‘Lit. Who_i do you want to know whether this matter [*t_i*-benefited]?’

(15a) illustrates the *wh*-island constraint. Here, the *wh*-phrase *dare-ga* ‘who-NOM’ cannot yield matrix *wh*-scope interpretation due to the intervention of the embedded interrogative head, which blocks association between the *wh*-phrase and the matrix interrogative *no* or (covert) movement of the *wh*-phrase to the matrix specifier of the relevant marker. (15b) minimally

differs from (15a) in that the *wh*-phrase in the former now takes the *wh*-compound form, *dare-toku* ‘who-benefit’. Strikingly, (15b) remains ungrammatical on a par with (15a). This is thus our first indication that *wh*-compound questions are formed in the syntax in the same way as regular *wh*-questions.

Second, it is widely acknowledged in the literature on Japanese/Korean syntax that ungrammaticality results when a certain class of operators such as negative polarity items, universal quantifiers and disjunctive phrases c-command an in-situ *wh*-phrase. Furthermore, this intervention effect won’t surface when the *wh*-phrase in question undergoes scrambling out of the c-command domain of the interveners. For instance, (16a) is ungrammatical because the *wh*-phrase *nani-o* ‘what-ACC’ remains in the c-command domain of the disjunctive phrase *John-ka Bill-ga* ‘John or Bill’ as the intervener. This example is to be contrasted with the grammatical example in (16b), where the same *wh*-phrase scrambles out of the c-command domain to the sentence-initial position.

- (16) a. * John-ka Bill-ga nani-o tabeta-no?
 John-or Bill-NOM what-ACC ate-Q
 ‘What did John or Bill eat?’
 b. Nani-o John-ka Bill-ga t_i tabeta-no?
 what-ACC John-or Bill-NOM ate-Q
 ‘What did John or Bill eat?’

Exactly the same distribution is observed when the *wh*-phrase is replaced with a *wh*-compound question, *nani-nabe-o* ‘what-hot.pot.ACC’. This point is evidenced by the contrast between (17a) and (17b), which is completely parallel to that between (16a) and (16b).

- (17) a. * John-ka Bill-ga nani-nabe-o tabeta-no?
 John-or Bill-NOM what-hot.pot-ACC ate-Q
 ‘lit. [What-hot.pot] did John or Bill eat?’
 b. Nani-nabe-o John-ka Bill-ga t_i tabeta-no?
 what-hot.pot-ACC John-or Bill-NOM ate-Q
 ‘lit. [What-hot.pot] did John or Bill eat?’

The parallels between compound and regular *wh*-phrases go deeper with respect to the intervention effect. The intervention effect is lifted in embedded clauses (Tomioka 2007), as witnessed by (18a) with a regular *wh*-phrase *nani-o* ‘what-ACC’ in the embedded clause. Again, (18b) with the *wh*-compound *nani-nabe-o* ‘what-hot.pot-ACC’ does not exhibit the intervention effect in the embedded context in the same way as (18a).

- (18) a. * Mary-wa [_{CP} John-ka Bill-ga nani-o tabeta-atode] dekaketa-no?
 Mary-TOP John-or Bill-NOM what-ACC ate-after left-Q
 ‘*What_i did Mary leave after John or Bill ate t_i ?’
 b. Mary-wa [_{CP} John-ka Bill-ga nani-nabe-o tabeta-atode] dekaketa-no?
 John-TOP John-or Bill-NOM what-hot.pot-ACC ate-after left-Q
 ‘lit. [What-hot.pot]_i did Mary leave after John or Bill ate t_i ?’

Finally, novel data concerning additional *wh*-effects provide further support for our current

position. This effect is illustrated in (19a, b). (19a) is a baseline example illustrating the *wh*-island violation (see also (15a)). This violation, however, is somewhat ameliorated when an extra *wh*-phrase is added to the matrix clause, as shown by the grammaticality of (19b).

- (19) a.* John-wa [CP Mary-ga nani-o tabeta-kadooka] siritagatteiru-no?
 John-TOP Mary-NOM what-ACC ate-whether want.to.know-Q
 ‘lit. What_i did John wonder whether Mary ate t_i ?’
 b. John-wa [CP Mary-ga nani-o tabeta-kadooka] dare-ni tazuneta-no?
 John-TOP Mary-NOM what-ACC ate-whether who-DAT asked-Q
 ‘lit. Who_i did John ask t_i whether Mary ate what?’

Wh-compounds exhibit this matrix/embedded asymmetry with regards to the additional *wh*-effect. Examples (20a, b) both involve the *wh*-compound *nani-nabe* ‘what-hot.pot’. The ungrammaticality of (20a) shows that this compound is subject to the relevant effect in the matrix clause whereas the grammaticality of (20b) indicates that the effect is canceled when a matrix *wh*-phrase is added.

- (20) a.* John-wa [CP Mary-ga nani-nabe-o tabeta-kadooka] siritagatteiru-no?
 John-TOP Mary-NOM what-hot.pot-ACC ate-whether want.to.know-Q
 ‘lit. What_i did John wonder whether Mary ate t_i ?’
 b. John-wa [CP Mary-ga nani-nabe-o tabeta-kadooka] dare-ni tazuneta-no?
 John-TOP Mary-NOM what-hot.pot-ACC ate-whether who-DAT asked-Q
 ‘lit. Who_i did John ask t_i whether Mary ate what?’

To summarize, we have documented evidence to show that *wh*-compounds are accessible to regular syntactic operations and conditions. In the rest of this section, we will suggest one more supporting argument for this conclusion based on non-interrogative readings of the *wh*-compounds.

It has been commonly held since Kuroda (1965) that *wh*-words in Japanese are indeterminate pronouns whose meanings may vary among an interrogative pronoun, an existential quantifier, a universal quantifier, and a negative polarity item, depending on the particles (e.g., *no*, *ka*, and *mo*) locally associated with the *wh*-words in question. (21a) illustrates the use of *dare* ‘who’ as the negative polarity item triggered by the particle *mo*. Interestingly, the *wh*-compound counterpart to (21a), shown in (21b), retains the same reading. Examples in (22a–c) illustrate the availability of the universal reading of some *wh*-compounds.⁶ Furthermore, (23b) shows that a *wh*-compound, *darekasan-zemi* ‘lit. someone-seminar’, may also be used as an existential *wh*-compound in the same way as a regular *wh*-word like *darekasan-no zemi* ‘someone’s seminar’ (witness (23a)).

- (21) a. Boku-wa dare-no-zemi-mo ukenakatta.
 I-TOP who-GEN-seminar-MO didn’t.take
 ‘I didn’t take anybody’s seminar.’
 b. Kono kizi-wa dare-toku-ni-mo naranai.
 this article-TOP who-benefit-to-MO not.become
 ‘This article does not benefit anyone.’

⁶ We thank Tommy Tsz-Ming Lee (personal communication, August 2022) for encouraging us to check the availability of the negative polarity reading with *wh*-compounds and for much fruitful discussions on this point.

- (22)a. Boku-wa kyoo-wa nani-ryoori-de-mo ii-yo.
 I-TOP today-TOP what-cuisine-COP-MO good-SFP
 ‘I am okay with any cuisine for today.’
- b. Kare-wa Azia-no gengo-nara nani-go-de-mo hanaseru-yo.
 he-TOP Asia-GEN language-if what-language-COP-MO can.speak-SFP
 ‘He can speak any language as long as it is an Asian language.’
- c. Kinkyuusaigaizi-wa doko-zyoohoo-mo amari tayorininaranai.
 emergency.disaster.time-TOP where-information-mo that.much unreliable
 ‘In case of emergency and disaster, no information from anywhere is so reliable.’
- (23)a. Boku-wa dareka-san-no zemi-dake-wa sindemo uketaku-na-i.
 I-TOP someone-TIT-GEN seminar-only-TOP even.if.I.die would.not.take-SFP
 ‘I would not like to take someone’s seminar even if it costs me my life.’
- b. Boku-wa dareka-san-zemi-dake-wa sindemo uketaku-na-i.
 I-TOP someone-TIT-seminar-only-TOP even.if.I.die would.not.take-SFP
 ‘lit. I would not like to take [someone-seminar] even if it costs me my life.’

We take these examples, then, as strong evidence for syntactic accessibility of *wh*-compounds.

2.3 The Janus-Faced Profile of *Wh*-Compound Questions and the Ordering Paradox

Let us take stock of our findings. On one hand, we have presented data from sequential voicing, the Compound Accent Rule and lexical integrity to show that *wh*-compounds are recognized as words formed in the Lexicon according to the LH. On the other hand, we have also shown that *wh*-compounds not only create a genuine *wh*-question licensed by the interrogative C head, yielding partial answers targeting the *wh*-part alone, but also exhibit robust movement restrictions such as island effects, intervention effects and additional *wh*-effects. This mutually contradictory mixture of the various properties of the *wh*-compound question is summarized in Figure 1.

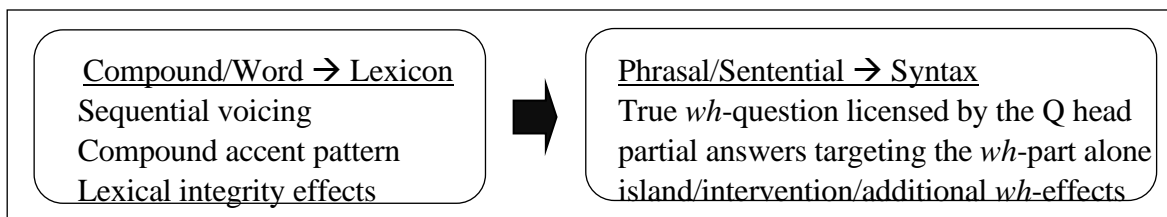

Table 1: *Wh*-Compound Questions: Lexical Wordhood and Syntactic Penetrability

It is clear from Table 1 that *wh*-compound questions simultaneously exhibit lexical wordhood and syntactic penetrability. To see theoretical implications of this finding for the syntax-morphology interface question we started our paper with, consider some representative definitions of lexical integrity proposed in the lexicalist literature shown in (24–26).

(24) Principle of Lexical Integrity (Anderson 1992:84)

The syntax neither manipulates nor has access to the internal structure of words.

(25) The Lexical Integrity Principle (Bresnan and Mchombo 1995:181–182)

Specifically, the morphological constituents of words are lexical and sublexical categories – stems and affixes – while the syntactic constituents of phrases have words as the minimal, unanalyzable units.

(26) The Atomicity Thesis (Di Sciullo and Williams 1987:48–49)

Words are ‘atomic’ at the level of phrasal syntax and phrasal semantics. The words have ‘features’ or properties, but these features have no structure, and the relation of these features to the internal composition of words cannot be relevant in syntax.’

Given the ‘feed-forward’ view of the morphology-syntax interface within which the LH is defined, the grammaticality of partial answers as illustrated in (12A) and (13A) would be mysterious, for a *wh*-compound should be atomic for syntax, as clearly stated in all the three definitions of Lexical Integrity given above. For the same reason, the output of the syntax, i.e., the left-member of a *wh*-compound with a *wh*-interrogative/existential/universal/negative polarity reading licensed by appropriate quantificational particles, should not be able to serve as input for compounding, a lexical process in the Lexicon, but our findings indicate otherwise. In this sense, *wh*-compounds raise a real architectural paradox for the LH-based conception of the syntax-morphology interface.

It is important to note that the paradox occurs precisely because the Lexicon is postulated in the lexicalist framework as an independent pre-syntactic module dedicated for word formation, thereby maintaining the LH as a syntax-morphology interface principle. For this reason, in the following section, we will put forth a purely syntactic analysis of *wh*-compounds within the DM framework which dispenses with the Lexicon as an autonomous grammatical module.

3. Renumerating *Wh*-Compounds: On the Re-Definition of ‘Word’ and ‘Wordhood’

Our analysis of the derivation of *wh*-compound questions in Japanese is modeled after a DM-based analysis of phrasal compounds proposed by Sato (2010) and Harley (2011) (see also Carnie 2000). The reason is that phrasal compounds exhibit the same ordering paradox for the lexicalist theory of the syntax-morphology interface as do *wh*-compound questions so that a plausible analysis of the former may point toward the kind of analysis needed for the latter.

In phrasal compounds, the first member is clearly formed in the syntactic module because its well-formedness is subject to regular syntactic rules and may be accessible to phrase-level interpretations. To illustrate these points, consider (27) and (28).

- (27) a. She had that [I’m-so-proud-of-myself] look.
 b. * She had that [Myself-is-so-proud-of-me] look. (Bruening 2018:3)

- (28) a. [Charles-and-Di syndrome] died when she died.
 b. He baked me [a sweet I-love-you cake], but I don’t think he really does. (Bruening 2018:7)

(27a) contains a well-formed compound because the lefthand member of the compound, *I’m so proud of myself*, is itself syntactically well-formed. This is not the case in (27b) because the first member of the attempted phrasal compound, *Myself is so proud of me*, is ungrammatical. (28a, b) show that part of a phrasal compound is accessible by syntactic anaphoric processes.

In (28a), the underlined part of the phrasal compound can be referred back to by *she*. In (28b), the underlined part of the phrasal compound provides an antecedent for the verb phrase ellipsis site to yield the sloppy reading that I don't think he really does love me.

3.1 Sato's (2010) DM-Style Analysis of Phrasal Compounds based on Renumeration

Sato (2010) proposes a purely syntactic analysis of phrasal compounds within the DM framework which draws on a combination of Johnson's (2004) concept of renumeration with Uriagereka's (1999) Multiple Spell-Out Model of syntax, whereby the Spelled-Out structure is returned to the main derivational workspace as a derived simplex lexical item or "giant compound". To illustrate Sato's analysis, consider the derivation of [*an-[I-drunk-too-much] headache*], shown in (29a–c).

(29) Deriving the Phrasal Compound, [*an-[I-drunk-too-much] headache*]

a. **Assemble TP:**

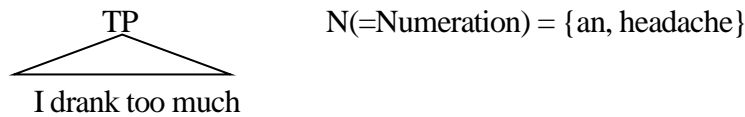

b. **Spell-Out & Renumerate TP:**

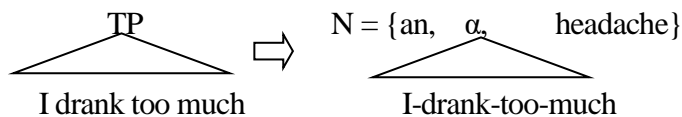

c. **Merge α with N and D:**

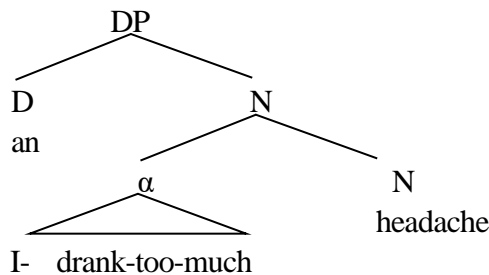

In (29a), the TP is assembled by syntax. It undergoes early spell-out and is returned to the numeration as a syntactic subtree, as shown in (29b), following Johnson's (2004) theory of Renumeration. The renumerated item is now returned to the derivational workspace as a derived lexical item or α , as depicted in (29c). The item then merges with *headache* and then with *a* to yield the phrasal compound, as desired. This analysis thus allows for a unified treatment of phrasal compounds and regular noun + noun compounds such as *a nurse shoe*, as indicated in its syntactic derivation shown in (30).

(30) Deriving the Noun + Noun Compound, *a nurse shoe*

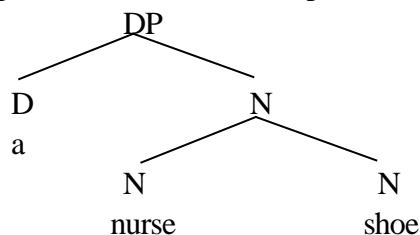

3.2 Renumerating *Wh*-Compound Questions in Japanese

Having laid out the analysis of phrasal compounds, we are now in a position to develop our analysis of *wh*-compound questions in Japanese which we have seen to raise essentially the same ordering problem as phrasal compounds. We will show how our analysis based on renumeration can successfully account for syntactic accessibility/penetrability of *wh*-compound questions through regular combinatorial processes in syntax while at the same time deriving their ‘lexical integrity’ effects through early spell-out. Consider the step-by-step derivation, shown in (32a–d), of the phrasal compound *nani-nabe* ‘what-hotpot’ from (13), repeated here as (31).

- (31) Q: Kimi-wa nani-nabe-o kinoo tabeta-no?
 you-TOP what-hot.pot-ACC yesterday ate-Q
 ‘lit. You ate [what-hot.pot] yesterday?’
 A: Kimuti-(nabe) da-yo.
 Kimchi-hot.pot cop-sfp
 ‘It was Kimchi hotpot (that I ate yesterday).’

(32) Deriving the *Wh*-Compound Question in (31Q)

a. Merge \sqrt{nabe} with *n* and D[Q]:

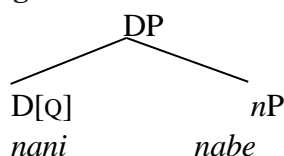

b. Percolation of the [Q] feature onto the DP:

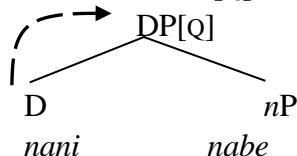

c. Spell-Out and Renumerate the DP:

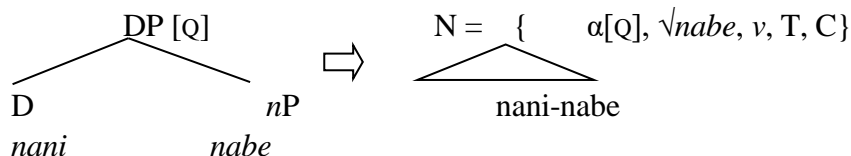

d. Merge α with \sqrt{nabe} , *v*, *T* and *C* plus [Q] agreement between α and *C*

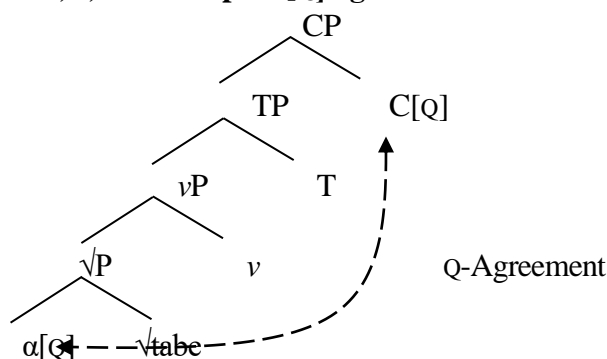

First, the DP is assembled from *nani* ‘what’ and *nabe* ‘hot.pot’, as in (32a). We assume,

following Nishigauchi (1986, 1990), that [Q] feature percolates from the D head onto its dominating DP, as in (32b). The DP structure is then spelled-out early and renumerated, as in (32c), before it returns to the derivational workspace as a derived terminal node with the [Q] feature and successively merges with \sqrt{tabe} , *v*, T and C, followed by Q-agreement between α and the interrogative particle.

Let us now check to see how the Janus-faced hybrid nature of *wh*-compound question formation, summarized in Table 1, can be accommodated in our system. On one hand, the cluster of syntactic properties noted in the table manifest themselves because it is derived in the syntactic derivation in accordance with regular syntactic conditions regulating *wh*-interrogative formation and island/intervention effects. On the other hand, the signature lexical properties associated with *wh*-compound questions summarized in the table can be derived as an epiphenomenal consequence of the derivation in which the compound parts undergo spell-out/reenumeration and are returned to the derivational cascade as a derived giant compound which is synonymous with the lexicalist notion of ‘word’. More broadly, then, one notable theoretical implication of our analysis is that it puts forth a new DM-compatible system to derive ‘wordhood’ using basic assumptions of minimalist syntax without necessarily invoking the notion of ‘word’. This point cannot be emphasized enough, for the issue how wordhood arises in such a framework has never been properly addressed in the literature. According to our system, ‘word’ in a language *L* may be re-characterized in terms of (subsets of) “possible spell-out domains” in *L* whereas ‘wordhood’ in *L* is nothing but a byproduct attached to renumerated items in *L* on a language-particular basis.

Before leaving this section, we address one question with our analysis. Recall from section 2.1 that *wh*-compounds exhibit a lexical integrity effect to the effect that nothing may intervene between the *wh*-word and the head noun of the compound, as illustrated in (11a–c). The question is how our approach can block such examples. To take (11b), nothing in our system appears to block the derivation where *nabe* ‘hotpot’ merges with the adjective *oo* ‘big’, and the resulting syntactic object, in turn, merges with the D head *nani* ‘what’ to yield *nani-oo-nabe* ‘lit. what-big-hotpot’.⁷

We think that there is no need to block such examples because they are actually grammatical, and that their alleged lexical integrity effects can be explained away by independent factors related to encyclopedic knowledge of the stems involved. For example, *nabe* in Japanese by itself is ambiguous between a pan (a cooking utensil) or a cuisine (a type of food severed), but once it is modified by scalar adjectives such as *ookii* ‘big’, it prototypically loses the latter reading but can only yield the former reading due to their selectional restrictions on the type of its modifyees. The contrast between (33a) and (33b) supports this observation.

- (33) a. *oo-nabe* ‘big pot’ (a pan; #cuisine)
big-pot
- b. * *Kimuti-oo-nabe* ‘intended: Kimchi hot.pot’
Kimchi-big-pot

It follows then that merging the *wh*-word *nani* ‘what’ and *oo-nabe* ‘big pot’ as a *wh*-compound asking for the identity of the kind of cuisine results in semantic anomaly, as shown in (11b), though it is perfectly grammatical as far as syntactic derivation is concerned. Our position that the perceived unacceptability of (11b) is due to encyclopedic knowledge of the lexically

⁷ We thank Ken Takita (personal communication, August 2022) for asking us this question and Satoshi Oku (personal communication, August 2022) for sending us an answer to the question to be outlined below and helpful discussions.

ambiguous stem is further supported by the observation that in a restricted range of cultural contexts, *nabe* may be used exceptionally to specify the name of a cuisine as long as the relevant cuisine is widely known to be served using a large-sized pan. One such case is the expression shown in (34), where *oonabe* can combine with *imo* ‘taro’ to yield *imonioonabe* ‘taro-and-meat soup hotpot’.

- (34) Kinoo-wa Yamagata-de imoni-oo-nabe-o itadaki-masi-ta.
 Yesterday-TOP Yamagata-in taro.and.meat.soup-big-pot-ACC eat-POL-PST
 ‘Yesterday, I enjoyed eating a taro-and-meat soup big hotpot in Yamagata.’

A similar characterization applies to (11c). (35a) illustrates one instance of the *wh*-compound headed by *zyooho* ‘information’ separated from a *wh*-word by an intervening modifier. As for (11a), we did not manage to find any such *wh*-compound, but there are still attested examples as in (35b), structurally akin to (11a), where the two members of the compound, *kappuru* and *toku*, are disrupted by a degree modifier, *metya* ‘extremely’, but the result is acceptable.

- (35) a. Sore-tte doko-soosu-zyoohoo?
 that-TOP where-source-information
 ‘intended: That is information from [where-source]?’
 b. Kappuru-metya-toku tabi-puran
 couple-extremely-benefit travel-plan
 ‘intended: a travel plan that benefits a couple’

4. Concluding Remarks

In this paper, we have shown that *wh*-compound questions in Japanese transcend the traditional “word vs. phrase/sentence” boundary as postulated by the lexicalist model of the syntax-morphology interface and that this intermodular nature of the questions poses a non-trivial ordering paradox for such a model. We have argued that their wordhood and internal syntactic accessibility fall out most naturally if they are formed exclusively within the syntactic derivation, as argued in the anti-lexicalist framework such as the DM. One broad implication of our analysis is that one may eliminate the notion of ‘word’ from the theory of grammar in favor of the syntactic definition of “the set of possible spell-out domains” in a derivational model, with ‘wordhood’ being an epiphenomenal effect attached to the renumeration process in the computational cycle.

In a DM-worldview with no clear lexicon-syntax divide, more and more phenomena are expected to be found that blur the distinction between ‘word’ and ‘phrase/sentence’. For reasons of space, we will only mention below two such cases. First, Ogawa (2022) shows that certain nouns may take a complex syntactic object as their complement, as in (36); note that the formal noun *kiri* undergoes sequential voicing, suggestive of the inclusion of a syntactic phrase within an ostensibly ‘word’ domain. Second, (37) illustrates just “off-the-cuff” phrasal compounds in casual Japanese speech. This type of compound is freely generated on the spot, taking the output of combinatorial syntax as its input for compounding (see also Ackema and Neeleman 2004 and Carnie 2000).

(36) Taro-to-wa [TP/CP getsuyooobini wakareta] {kiri/giri} atteinai.
 Taro-with-TOP on. Monday left after have.not.seen
 ‘We have not seen Taro since we left him on Monday.’ (Ogawa 2022:3)

(37) [CP Getuyoo itigen-ni-wa zettai derenai] zoku
 monday first.period-to-TOP absolutely cannot.attend tribe
 ‘a tribe (of university students) who absolutely cannot attend any first period class on Mondays.’

References

- Ackema, Peter, and Ad Neeleman. 2004. *Beyond morphology: Interface conditions on word formation*. Oxford: Oxford University Press.
- Anderson, Stephen. 1992. *A-morphous morphology*. Cambridge: Cambridge University Press.
- Beck, Sigrid. 1996. Quantified structures as barriers for LF movement. *Natural Language Semantics* 4:1–56.
- Beck, Sigrid, and Shin-Sook Kim. 1997. On *wh*- and operator scope in Korean. *Journal of East Asian Linguistics* 6:339–384.
- Bresnan, Joan, and Sam Mchombo. 1995. The lexical integrity principle: Evidence from Bantu. *Natural Language and Linguistic Theory* 13:181–254.
- Bruening, Benjamin. 2018. The lexicalist hypothesis: Both wrong and superfluous. *Language* 94:1–42.
- Carnie, Andrew. 2000. On the definitions of X^0 and XP. *Syntax* 5:59–106.
- Chomsky, Noam. 1970. Remarks on nominalization. In *Readings in English transformational grammar*, ed. by Roderick A. Jacobs and Peter Rosenbaum, 184–221. Waltham: Ginn.
- Di Sciullo, Anna Maria, and Edwin Williams. 1987. *On the definition of word*. Cambridge, Mass.: MIT Press.
- Embick, David, and Rolf Noyer. 2007. Distributed morphology and the syntax-morphology interface. In *The Oxford handbook of linguistic interfaces*, ed. by Gillian Ramchand and Charles Reiss, 289–324. Oxford: Oxford University Press.
- Halle, Morris, and Alec Marantz. 1993. Distributed morphology and the pieces of inflection. In *The view from Building 20: Essays in linguistics in honor of Sylvain Bromberger*, ed. by Kenneth Hale and Samuel Jay Keyser, 111–176. Cambridge, Mass.: MIT Press.
- Harada, Naomi. 2014. *Wh*-compounds: A preliminary study. *The Journal of Social Sciences and Humanities* 487:23–36. Tokyo: Tokyo Metropolitan University.
- Harley, Heidi. 2011. Compounding in Distributed Morphology. In *The Oxford handbook of compounding*, ed. by Rochelle Lieber and Pavol Stekauer, 129–144. Oxford: Oxford University Press.
- Harley, Heidi, and Rolf Noyer. 1999. State-of-the-article: Distributed morphology. *GLOT International* 4: 3–9.
- Hoji, Hajime. 1985. Logical form constraints and configurational structures in Japanese. Doctoral dissertation, University of Washington.
- Johnson, Kyle. 2004. Towards an etiology of adjunct islands. *Nordlyd* 31:187–215.
- Kageyama, Taro. 1993. *Bunpoo to gokeisei* (Grammar and word formation). Tokyo: Hituzi Syobo.
- Kimura, Hiroko, and Hiroki Narita. 2016. Focus-inclusive deletion in fragment answers: Evidence from Japanese. In *Proceeding of the 18th Seoul International Conference on Generative Grammar (SICOGG18)*, ed. by Tae Sik Kim and Seungwan Ha, 225–245. Seoul: The Korean Generative Grammar Circle.
- Kimura, Hiroko, and Hiroki Narita. 2017. In-situ properties of fragment answers: Evidence from Japanese. In *MIT Working papers in Linguistics #48: Proceedings of GLOW in Asia XI, Volume 1*, ed. by Michael Yoshitaka Erlewine, 141–155. Cambridge, Mass.: MITWPL.
- Kimura, Hiroko, and Hiroki Narita. 2021. Compound *wh*-questions and fragment answers in Japanese: Implications for the nature of ellipsis. *Linguistic Inquiry* 52:195–209.
- Kubozono, Haruo. 1995. *Gokeisei to oninkoozoo* (Word formation and phonological structure). Tokyo: Kuroshio Publishers.

- Kuroda, S.-Y. 1965. Generative grammatical studies in the Japanese language. Doctoral dissertation, MIT.
- Marantz, Alec. 1997. No escape from syntax: Don't try morphological analysis in the privacy of your own lexicon. In *University of Pennsylvania Working Papers in Linguistics 4: Proceedings of the 21st Annual Penn Linguistics Colloquium*, ed. by Alexis Dimitriadis, Laura Siegel, Clarissa Surek-Clark, and Alexander Williams, 201–225. Philadelphia: Penn Linguistics Club.
- Namiki, Takayasu. 2003. On the expression *rinse in shampoo*: A new type of Japanese compound coined from English words. In Shuji Chiba et al. (eds.), *Empirical and theoretical investigations into language: A festschrift for Masaru Kajita*, 538–550. Tokyo: Kaitakusha.
- Nishigauchi, Taisuke. 1986. Quantification in syntax. Doctoral dissertation, University of Massachusetts, Amherst.
- Nishigauchi, Taisuke. 1990. *Quantification in the theory of grammar*. Dordrecht: Kluwer.
- Ogawa, Yoshiki. 2022. Grammaticalization and sequential voicing in Japanese. In *Phonological externalization, vol. 7*, ed. by Hisao Tokizaki, 1–26. Sapporo: Sapporo University.
- Saito, Mamoru. 1994. Additional-*wh* effects and the adjunction site theory. *Journal of East Asian Linguistics* 3: 195–240.
- Sato, Yosuke. 2010. Complex phrase structures within morphological words: Evidence from English and Indonesian. *Lingua* 120:379–407.
- Taraldsen, Knut Tarald, 2019. An introduction to nanosyntax. *Linguistics Vanguard* 5:1–11.
- Tomioka, Satoshi. 2007. Pragmatics of LF intervention effects: Japanese and Korean *wh*-interrogatives *Journal of Pragmatics* 39:1570–1590.
- Uriagereka, Juan. 1999. Multiple spell-out. In *Working minimalism*, ed. by Samuel D. Epstein and Norbert Hornstein, 251–282. Cambridge, Mass.: MIT Press.
- Watanabe, Akira. 1992. Subjacency and S-structure movement of *wh*-in-situ. *Journal of East Asian Linguistics* 1:255–29

Nonrestrictive Relative Clauses as a Limiting Case of CP Sequences*

Yohei Takahashi**

Tokyo University of Information Sciences

1. Introduction

The aim of this study is to examine the validity of Form Sequence (FSQ) proposed by Chomsky (2019, 2020, 2021a, 2021b) as a computational device for generating order-restricted units. Following the original insight of Chomsky that every emergence of XP is the limiting case of a sequence, I explore the possibility that FSQ also applies to CP sequence. Then, I argue that FSQ provides a persuasive explanation of the syntax of non-restrictive relative clauses (NRCs) in languages like English (what Cinque (2008, 2020) categorizes as a variety of non-integrated NRC). As a result, in spite of the failure to lessen the computational burden, it becomes possible to provide a better typology of relative constructions in terms of ways of structure building by adopting FSQ to give an order-restricted unit together with MERGE or whatever it substitutes for. This article proceeds as follows: Section 2 provides the background of this study. Section 3 offers a proposal for the syntax of English NRCs in terms of FSQ, demonstrating a number of their characteristics as an independent clause that they show can be explained under the proposal that English NRCs are a part of CP sequences together with matrix CPs. Section 4 discusses empirical consequences of the proposal with reference Cinque's (2020) diagnoses and some implications for licensing ellipsis. Section 5 concludes this article and provides some future prospects of this study.

2. Background

Section 2.1 provides a brief description of FSQ and summarizes its problems. Then, Section 2.2 presents a brief review of English NRCs, highlighting the fixed postnominal linear order, their characteristics as an independent clause, and their property of unboundedness. In Section 2.3, we will first review some of the major syntactic approaches to NRCs, then point out long-standing dilemmas arising in exchange for accommodating the properties.

2.1 FSQ and Open Problems

In several seminal studies of (2019, 2020, 2021a, 2021b), Chomsky proposes Form Sequence (FSQ) as a computational component that produces an order-restricted flat structure like (1) taking n members X of WS.

- (1) a. $WS = \{X_1, \dots, X_n\} \rightarrow MERGE \ \& \ \text{and} \ Apply \ FSQ \rightarrow WS = \langle (\&), X_1, X_n \rangle$
 b. Every emergence of XP is the limiting case of a sequence.

* An earlier version of this article was presented at GLOW in Asia XIII, hosted by the Department of Linguistics and Modern Languages of the Chinese University of Hong Kong. I would like to the participants of the conference and the anonymous reviewers for the invaluable comments. I am grateful to Norimasa Hayashi and Miyuki Sawada for their comments and helpful suggestions after my flash talk. Also, for the earlier version of this research, I received much cooperation and many useful comments as well as a set of insightful data, for which I would like to thank Shigeo Tonoike, Guglielmo Cinque, Hiroki Egashira, and Josh Bowers. Of course, I am solely responsible for all remaining errors in this paper.

** y3takaha21@rsch.tuis.ac.jp

The expected candidates benefitting from FSQ are unbounded unstructured sequences like (2a), and any syntactic object (SO) conventionally restricted by Coordinate Structure Constraint (CSC) like (2b) (*cf.* the works of Chomsky mentioned above, as well as Goto and Ishii (2021)).

- (2) a. John, Bill, my friends, the actor of who won the Oscar, ... ran, danced, took a vacation...
(Chomsky (2021b: 31))
- b. (i) John lived [_{CoP} [_{PP} on a farm] and [_{PP} with his family]]
(ii)*which farm did John live on which farm and with his family (*Ibid.*, 32, slightly modified)

However, as recognized by Chomsky in the works mentioned above, FSQ leaves much room for further investigation, which can be summarized as follows:

- (3) a. In addition to the instances discussed so far, to what extent does FSQ explain linguistic facts?
b. Under the theory of Simplest MERGE, can we replace Pair-MERGE with FSQ as a device for generating order-restricted units?
c. What does FSQ imply for other core components of the computational system?

This study starts by addressing the assumption of (1b) in order to address the question of (3a), because empirical studies of FSQ have been very limited in the literature (*e.g.*, Goto and Ishii (2021)). On the other hand, regarding (3b), there have been many studies that have sought to remove Pair-MERGE of (*cf.* Chomsky (2004)) from the computational system under the tenet of Simplest MERGE. If FSQ is available for generating order-restricted flat linguistic units, then it is naturally expected to serve as an aid to meeting this goal. Finally, the examination of (3c) is also important. FSQ is in fact a complex operation that consists of Form Set, merger of &, and rendering a flat SO.

2.2 Brief Review of English NRCs

Compared with restrictive relative clauses (RRCs), it is widely known that English NRCs show characteristics of an independent clause.¹ For example, they can be illocutionary independent from a matrix clause. The relative CP in (4a) carries an interrogative force, the one in (4b) carries an imperative force, and the one in (4c) carries an optative force.

- (4) a. It may clear up, in which case would you mind hanging the washing out?
b. He said he'd show a few slides towards the end of his talk, at which point please remember to dim the lights! (Huddleston and Pullum (2002: 1061))
c. My friend, who God forbid you should ever meet... (Cinque (2020): 153)

Another demonstration of this nature comes from the fact that matrix clauses cannot take scope over NRCs in terms of c-command. (5) shows the failure to license the negative polarity item (NPI) *any* in the relative CP.

- (5) *I didn't see a man, who had had any drinks. (Nakamura and Kaneko (2002: 80))

Moreover, some instances of NRCs may exhibit Root Transformation. (6a) is an instance of

¹ See, for instance, Looch (2007), who provides an intricate classification of English NRCs from semantic and pragmatic perspectives.

negative constituent preposing while (6b) is an instance of tag-question.²

- (6) a. This car, which only rarely did I drive, is in excellent condition.
 b. I just ran into Susan, who was your roommate at Radcliffe, wasn't she?
 (Hooper and Thompson (1973: 489-490))

On the other hand, although it seems somewhat controversial, it is reported that English allows stacking of NRCs in terms of antecedent specification (*cf.* Vries (2006)).

- (7) a. The sole, which I bought yesterday, which was caught in Scotland, was delicious.
 (Kempson (2003: 303))
 b. This man, who came to dinner late, about whom nobody knew anything, ...
 (Vries (2006: 252))
 c. ?Sam Boronowski, who took the qualifying exam, who failed it, wants to retake it.
 (McCawley (1998: 447 and n.13))

It seems safe to say that relative clause stacking is one kind of realization of linguistic unboundedness. Taking these facts into consideration, we are tempted to explore the possibility that English-type NRCs may be explained in terms of FSQ.

2.3 Major Approaches and Dilemmas

The history of research on the syntax of NRCs is rich. With the transition of the theoretical framework, they have received a fresh explanation in terms of a newly conceived theoretical device.³ Prior to minimalism, two conflicting approaches had been entertained: the Main Clause Approach (*e.g.*, Ross (1967), Emonds (1979), and McCawley (1981)), where an independent clause undergoes relativization as result of transformation; and the Adjunction Approach (*e.g.*, Jackendoff (1977), Demirdache (1991), and Citko (2008)), in which a relative CP merges with its antecedent via adjunction.⁴ On the other hand, analyses by Kayne (1994) and Bianchi (1999) were proposed during the development of Kayne's antisymmetry theory. Such Antisymmetry Approaches assume NRC CPs to move out of the scope of relative determiner at LF. Furthermore, Vries (2006) entertains the Coordinate Structure Approach, in which an antecedent XP and NRC form a coordinate structure in terms of semantic specifying coordination. Later, Vries (2012) and Gobbo (2017) proposed the involvement of a functional head, through which the anti-c-commanding effect of NRCs is intended to be explained.⁵

Through the careful examination of each proposal, we can recognize that one of the major concerns at stake has been how to salvage their nature as an independent clause. As long as scope is defined in terms of c-command, we can rephrase this problem in a minimalist fashion, asking why an English-type NRC and its host clause are invisible to each other. The

² I thank Hiroki Egashira for drawing my attention to the availability of Root Transformation.

³ See also Hayashi (2018) for a concise yet thorough summary of major approaches to NRCs. Hayashi also develops the Counter-Cyclic Pair-MERGE Approach to English NRCs in the work.

⁴ Demirdache's approach also adopts a movement of NRC CP at LF.

⁵ Gobbo (2017) assumes English NRCs to be *non-integrated* following the distinction defined by Cinque (2008, 2020). Del Gobbo hypothesizes bi-functional layers for their syntax, CommaP and ForceP. In the sense of Potts (2005), the former functional head Comma induces a variable for the content of the constituent in its scope, so it bars any binding from a matrix clause. On the other hand, the latter functional head Force is attributive to Koev (2013), who argues that this head introduces an operator-variable construction within the scope of Force.

leading approaches that we have just reviewed face a difficult dilemma between guaranteeing their explanatory force and emphasizing the desiderata of the computational system. For example, suppose that we choose Main Clause Approach; it could elegantly capture the interpretational compatibility of NRC with a corresponding independent clause. However, transformation is no longer a viable computational option within the minimalist framework. Next, consider the Adjunction Approach, while leaving aside the controversial status of adjunction inside the computational system. The widely accepted view that adjunction induces structural antisymmetry, commonly segmentally notated by $\{\alpha, \{\alpha, \beta\}\}$, apparently contradicts the scope fact mentioned above. That is because if adjunction were adopted, the putative matrix SO α could c-command β , putatively regarded as the relative CP, thereby wrongly predicting that (5) would be acceptable. How then about the Coordinate Structure Approach? Under the theory of Simplest MERGE, of course, there is no room to accept trinary MERGE of an antecedent, Coordinator head (*e.g.*, ‘Co’ of Vries (2006)), and relative CP within the desideratum of the computational system. However, even if we followed the tenet of binary MERGE maintaining the Coordinate Structure Approach, we would be obliged to adopt stipulative devices, saying, for example, that although CoP and NRC are in a sister relation, CoP does not c-command NRC. Lastly, concerning Functional Head Approach, further scrutiny is required as to whether categories like ‘Par(enthesis)’ (*e.g.*, Vries (2012)) and ‘Comma’ (*e.g.*, Potts (2005), Gobbo (2017)) are universal in the architecture of UG specified for English. Granted that they are, we still have to make some stipulation to exempt asymmetric c-command of NRCs by the heads, which inevitably complicates the tenet of Simplest MERGE.

3. Proposal: English NRCs as a Limiting Case of CP Sequences

We are now ready to argue for an alternative approach to the syntax of English-type NRC. I adopt (8) as a theoretical hypothesis:

- (8) Any SOs related in terms of coordination (&) undergo FSQ in Narrow Syntax (NS) after they exhaust the elements of WS.

Then, I propose (9) for the derivation of English-type NRCs.

- (9) a. *English-type NRCs as a Limiting Case of CP Sequences*
 In languages like English, matrix and NRC CPs undergo FSQ in NS after they exhaust the elements of WS.
- b. $\langle (\&)\{CP_1 C \dots XP_1 \dots\}, \{CP_2 wh_i C \dots \cancel{wh}_i \dots\} \rangle$
 where...
 CP₁ = matrix clause;
 CP₂ = NRC;
 XP = antecedent;
 wh = E-type relativizer (*cf.* Sells (1985), Demirdache (1991), Gobbo (2017))

In (9b), the binding relation among the related elements, *i.e.*, antecedent XP and upper and lower *wh*, is captured in terms of the latest version of Form Copy.⁶ Within the relative CP, two

⁶ An anonymous reviewer questioned how our alternative could accommodate the Weak Cross Over (WCO) effect attested in English NRC without positing the IM of *wh* relativizer.

occurrences of *wh* relativizer form IM Configuration; thus, I assume that Predicate Abstraction of Heim and Kratzer (1998) can be executed in terms of this configuration.⁷ From a type-theoretical view, it is predicted that two sequential CP inputs carry the same truth-value, namely *t*. As assumed in (9b), the *wh* relativizer in SpecCP is an E-type pronoun, thus identified as type *e*. If it forms IM Configuration with the lower *wh* with the semantic type *e*, it consequently fulfills the role of Predicate Abstraction, rendering the IP projection into type $\langle e, t \rangle$. I adopt a conventional tree notation in (10) for the sake of convenience.

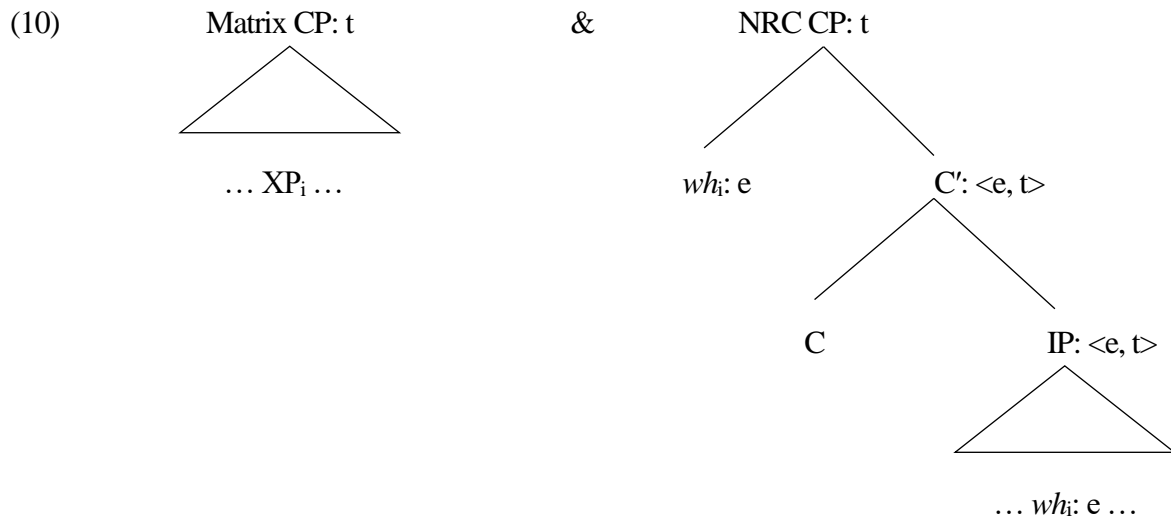

We note the remarkable fact that the characteristics that we reviewed in Section 2 can be accommodated under this proposal. First, the clausal independence of each CP exemplified in (4a-c) naturally follows from its consistent lack of structural hierarchy. Second, the matrix clause and NRC form a linear flat sequence where neither mutual nor antisymmetric c-command is observed, correctly predicting why the NPI licensing in (5) is impossible. Third, concerning (6-7), the constant linear order Matrix CP > NRC CP is fixed by the application of FSQ without going into the dilemma entailed by any approaches that posit the (in)direct merger of antecedent XP and relative CP.⁸

(i) [?] I met John_i, who his_i sister is really fond of *t_i*.

In his recent publications, Chomsky repeatedly emphasizes that derivation is so strictly Markovian that the computational system cannot detect whether IM took place in the previous derivational steps. The interpretational device INT does nothing but detects a determined configuration for discontinuous SOs to be recognized as Copies no matter how their configuration was formed, namely External MERGE (EM) or IM. If so, the EM option opens up the possibility that the relevant WCO effect is derived under our alternative approach, which obviously requires further scrutinization.

⁷ As in the case of RRC, the emergence of a *wh* relativizer suggests the involvement of operator movement (IM). However, as has been much discussed in the literature, *wh* relativizers in NRCs are not so much an operators as bound pronouns, given their contextual dependency. If we adopt the latter position, it seems somewhat mysterious why the bound pronoun moves to SpecCP. However, although it requires further examination, I suppose that Form Copy under IM Configuration might be a solution if the interpretive system INT can recognize two *base-generated* occurrences of a *wh* relativizer as Copies of the same item. I thank Shigeo Tonoike and Miyuki Sawada for having turned my attention to this issue.

⁸ The directionality of linearization of two CPs in English NRC is the same as canonical instances of FSQ, namely a sequence that carries a coordinator follows one without it. Of course, I admit a principled explanation as to why this is so is lacking.

4. Empirical Consequences

In this section, I will further argue the empirical consequences entailed by the alternative FSQ account, referring to Cinque's (2020) diagnoses that sharply contrast the differences between integrated NRCs and non-integrated NRCs. See (11).⁹

(11) *Table 1*

| Example | Integrated NRC | Non-Integrated NRC |
|--------------------------------|------------------------------|--------------------------------------|
| | Italian <i>che / qui</i> NRC | English, Italian <i>il quale</i> NRC |
| (i) Illocutionary Independency | <i>No</i> | <i>Yes</i> |
| (ii) Antecedents other than DP | <i>No</i> | <i>Yes</i> |
| (iii) Non-Adjacency | <i>No</i> | <i>Yes</i> |
| (iv) Split Antecedents | <i>No</i> | <i>Yes</i> |
| (v) Parasitic Gaps | <i>Yes</i> | <i>No</i> |

I have already discussed how illocutionary dependency is tolerated under the FSQ account. While non-integrated NRCs form a flat sequence structure with a matrix CP, integrated NRCs do not, and RRC CPs are literally integrated into the structure of matrix CP. If so, contrast (i) naturally follows. In what follows, let us consider how (ii-v) are accommodated under the alternative account.

4.1 Antecedents other than DP

First, while the antecedent of RRCs is limited to NP, that of NRCs can take various categories of XP projection. The paradigms in (12) are taken from English, which presents instances of non-integrated NRCs: (12a) has a CP antecedent, (12b) an AP antecedent, and (12c) a VP antecedent.

(12) *English*

- a. *Sheila was beautiful*, which was too bad. (Ross (1969a: 357))
 b. She was *fond of her boy*, which Theobald never was. (Jespersen (1949: 124))
 c. Joe *debated in high school*, which Chuck did too. (Thompson (1971: 84))

The same pattern as (12) is also attested in (13) regarding Italian *il quale* NRCs, which can be categorized as non-integrated NRCs: (13a) has a CP antecedent, (13b) an AP antecedent, and (13c) a VP antecedent.

(13) *Italian il quale NRC*

- a. *Carlo lavora troppo poco*. La qual cosa verrà certamente notata.
 C. works too little which.thing will certainly noticed
 'Carlo works too little, which will be certainly noticed.' (Cinque (1988: 467), italicized mine)
 b. *Maria è suscettibile*. La qual cosa sua sorella di certo non è.
 M. is touchy which.thing her sister certainly not is
 'Maria is touchy, which her sister is certainly not.' (Cinque (2020: 151), italicized mine)
 c. *Maria interveniva sempre*. La qual cosa faceva anche sua madre.
 M. intervened always which.thing did also her mother
 'Maria was always speaking up, which her mother also used to do.' (*Ibid.*, 151, italicized mine)

⁹ Some of the facts reported in Cinque's work are omitted in the table and the discussion below.

On the other hand, Italian *che / qui* NRCs, which are categorized as integrated NRCs, do not tolerate antecedents other than DP. See (14), in which there are integrated counterparts of (13).

(14) *Italian (che / qui NRC)*

- a. **Carlo lavora troppo poco.* Che verrà certamente notata.
 C. works too little that.will.come certainly noticed
 ‘Carlo works too little, which will be certainly noticed.’ (Cinque (2020: 150), italicized mine)
- b. **Maria è suscettibile.* Che sua sorella di certo non è.
 M. is touchy that her sister certainly not is
 ‘Maria is touchy, which her sister is certainly not.’ (*Ibid.*, 151, italicized mine)
- c. **Maria interveniva sempre.* Che faceva anche sua madre.
 M. intervened always that did also her mother
 ‘Maria was always speaking up, which her mother also used to do.’ (*Ibid.*, 151, italicized mine)

This characteristic can be predicted in the FSQ account because there are no factors to prevent the account from integrating the insight that a *wh* relativizer in non-integrated NRCs is an E-type pronoun. E-type pronouns are considered able to pick up a reference denoted by any syntactic category. Thus, the facts illustrated in (12-13) safely follow under the account.

4.2 Non-Adjacency

The term “adjacency” here indicates the state where an antecedent and relative CP are linearly and directly next to each other. It is reported that while integrated NRCs must be strictly adjacent to their antecedents, non-integrated NRCs need not be. (15) is taken from Fabb (1990), where the adverb *yesterday* intervenes between the antecedent and the relative clause.

- (15) I met John yesterday, who I like a lot. (Fabb (1990: 59))

This fact poses a threat to any proposals that assume the direct merger of the relative CP to the antecedent XP. However, the FSQ account can accommodate this fact because it does not assume such merger, but instead relates a whole matrix clause that contains the antecedent and the relative CP in terms of a sequential unit. Even if the adverb were accidentally placed at the end of the matrix CP sequence, it would not contradict the grammaticality.

4.3 Split Antecedents

Split antecedents are known as a discourse grammar phenomenon in which pronouns refer to more than one antecedent in an ongoing discourse. Cinque points out that non-integrated NRCs can have split antecedents, although integrated NRCs cannot.

(16) *English*

- Kim likes muffins_i, but Sandy prefers scones_j, which_{i+j}* that they eat with jam.
 (Cinque (2020: 154), gloss modified)

(17) *Italian il quale NRC*

- Se Carlo_i non amava più Anna_j, i quali_{i+j} d'altra parte non si erano mai voluti
 if C. no longer loved A. who at.any.rate they.really.never-PAST loved
 veramente bene, una ragione c'era.
 really.good a reason there.was

Intended reading: ‘If Carlo no longer loved Anna, who at any rate loved each other, there was a reason.’
(*Ibid.*, 148, gloss modified)

(18) *Italian che/qui NRC*

* Se Carlo_i non amava più Anna_j, che_{i+j} d’altra parte non si erano mai voluti
if C. no loved more A. who at.any.rate they.really.never-PAST loved
veramente bene, una ragione c’era.
really.good a reason there.was

Intended reading: ‘If Carlo no longer loved Anna, who at any rate loved each other, there was a reason.’
(*Ibid.*, 148, gloss modified)

I suppose that under the alternative account, these can be explained in terms of the availability to host an E-type pronoun and the constant flat structure derived by FSQ. First, it is widely accepted that E-type pronouns can refer to more than one reference in a sentence, so the relativizers in (16) and (17) can be bi-referential if they are E-type pronouns. Furthermore, as seen in (19), taken from Evans (1980), typical instances of E-type pronoun do not require structural binding by an antecedent, and this is safely met in the proposed sequential model.

- (19) a. Few congressmen admire Kennedy, and they are very junior.
b. John owns some sheep and Harry vaccinates them in the Spring. (Evans (1980: 339))

4.4 Parasitic Gaps

The final diagnosis adopted from Cinque (2020) is the contrast in the availability to license parasitic gaps inside relatives. Cinque thoroughly shows that while RRCs and integrated NRCs allow parasitic gaps inside the relative CP, non-integrated NRCs do not.¹⁰

(20) *English*

- a. John is a man who everyone who knows pg_i admires t_i . (RRC)
b. *John is a man who Bill, who knows pg_i , admires t_i . (NRC) (Safir (1986: 673))

(21) *Italian che/qui NRC*

La sola persona_i che quell_i che conoscono pg_i bene non possono non ammirare
The only person that those that know well cannot.but admire
 t_i è Gianni.
is G.

‘One person who the Rossi, who knows well, have always admired is Gianni.’
(Cinque (2020: 151))

¹⁰ Dubinsky (2006) raises other intriguing contrasts attributable to the difference between restrictive and appositive modification, such as (i-ii).

(i) Susan didn’t/*did sketch the building after sneaking any glances at it. (restrictive)
(ii) Susan didn’t sketch the building, only sneaking (*any) glances at it. (appositive)

Bošković (2019, 2020) pursues the possibility of deriving the unavailability of extraction from VP adjuncts like adverbials from that of coordination in a parallel manner. Taking these issues into consideration, we are tempted to adopt the FSQ approach under consideration for such instances as (ii), arguing that two VPs form a sequence, and thus extracting something from there violates the matching condition. I leave this issue for future research.

(22) *Italian il quale NRC*

*Una persona_i che i Rossi, i qual_i conoscono *pg*_i bene, hanno sempre ammirato *t*_i è
 one person that the R. who know well have always admired is
 Gianni.

G.

Intended reading: ‘One person that the Rossi, who know well, have always admired is Gianni.’

(*Ibid.*, 151)

Before arguing how this contrast can be accommodated under the alternative account, let me briefly examine background issues around parasitic gaps. It has been widely recognized that parasitic gaps must *not* be c-commanded by real gaps (*e.g.*, Taraldsen (1981)). However, the transition in the theoretical framework requires us to reconsider this premise. First, Chomsky (2021b) claims that given the instance of adjunct control in (23b), it is natural to think that computation can also look inside the adjunct that includes a parasitic gap in (23a).

(23) a. wh_1 did John₁ file wh_2 [without [wh_3 John₂ reading wh_4]]

b. John₁ wrote a memoir [without John₂ once referring to himself] (Chomsky (2021b: 35))

Second, taking the controversial status of adjunction into consideration, we are not sure whether we can maintain the insight that the adjunction of any SOs that contain a parasitic gap entails the configuration where real gaps do *not* c-command parasitic gaps. Thus, we should adopt an alternative approach rather than following the anti-c-commanding reasoning. Instead, I here assume Hayashi’s (2021) proposal on the licensing of parasitic gaps under Form Copy. Hayashi explains why parasitic gaps are parasitic to real gaps in terms of a requirement of Form Copy that INT cannot recognize an IM Configuration across more than one phase. See (24a, b).

(24) a. Which article did John file without reading?

IM Gap

b. $\{\zeta wh_1 \dots \{\varepsilon \{\delta wh_2 \dots \{\gamma \text{John file } wh_3\}\} \{\beta \text{without } wh_4 \{\alpha \text{reading } wh_5\}\}\}\}$

IM Copy

IM Copy

IM Copy

Phase level: α, γ, ζ

(Hayashi (2021: 4))

In (24b), we can see two kinds of IM Configuration: IM Copy and IM Gap. IM Copy is what we used for an A'-chain created by the application of IM. First, the IM Copy created from α to β corresponds to the operator movement within the adjunct SO, raising wh_4 to the adjunct SpecCP while leaving wh_5 in-situ as a parasitic gap. Second, the IM Copy created from γ to δ takes place in the matrix clause, raising wh_2 to the matrix SpecvP while rendering wh_3 into a real gap. Third, the IM Copy created across δ, ε , and ζ is a regular *wh*-movement that places wh_1 in the matrix SpecCP. On the other hand, the IM Gap (Markovian)-Gap in the sense of Chomsky (2021b)) is created between wh_2 and wh_4 . Note that since the derivation proceeds in a strictly Markovian manner, INT cannot look at a derivational history, so the recognition of Copy is totally independent from the actual execution of IM. Thus, as long as both wh_2 and wh_4 are visible in the single phasal cycle, it follows that INT can recognize them as Copies.

With this in mind, we now consider how the contrast in the grammaticality observed between RRC and non-integrated NRC as demonstrated in (20a, b) arises. Recall here that concerning the derivation of RRC, I do *not* adopt the FSQ account, but tentatively assume the merger of a relative CP to the antecedent, predicting (25) for (20a).

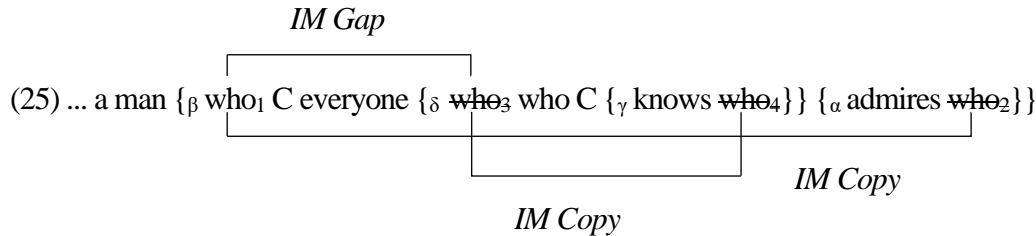

In (25) we find three IM Configurations associated with *who*. The formation of IM Copy $\langle \text{who}_3, \text{who}_4 \rangle$ takes place inside the deeply embedded RRC, moving *who*₃ in the SpecCP of δ while leaving *who*₄ in-situ as the parasitic gap. On the other hand, the other formation of IM Copy $\langle \text{who}_1, \text{who}_2 \rangle$ takes place inside the upper RRC, moving *who*₁ in the SpecCP of β while leaving *who*₂ in-situ as the real gap. Consequently, when the derivation reaches phase β , INT can recognize *who*₁ and *who*₃ as Copies in terms of IM Gap (M-Gap), thus explaining why (20a) is grammatical.

Now, let us turn to the unacceptable instances of NRC of (20b). In this case, the FSQ account is adopted. See (26).

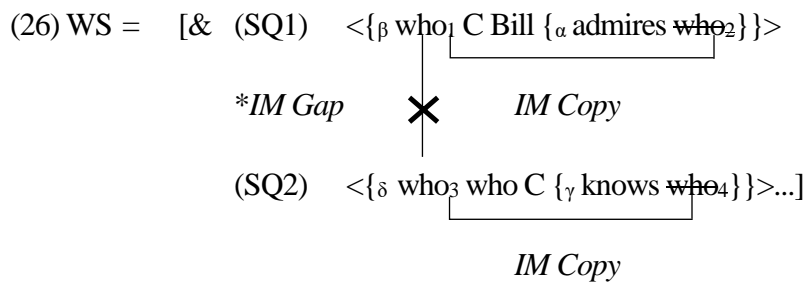

As with (25), the formation of IM Copy is executed in each sequence (SQ) in (26) as well. However, it is predicted that INT fails to recognize $\langle \text{who}_1, \text{who}_3 \rangle$ as Copies in terms of IM Gap because there is no hierarchical antisymmetry between two SQs, thus explaining why (20b) is ungrammatical.

4.5 Accommodating *One-Substitution* and *VP-Ellipsis* under the FSQ Account

Before leaving Section 4, I would like to remark on possible consequences of the FSQ account. Although Chomsky (2021a) suggests a difference in results of FSQ from those of Pair-MERGE in terms of extractability, I find it plausible to say that FSQ has different implications from Pair-MERGE for the purpose of licensing ellipsis. McCawley (1988) shows an interesting contrast concerning *one*-substitution between English RRC and NRC.¹¹

¹¹ According to Guglielmo Cinque (personal communication), *one*-substitution in the Italian counterpart of (27) is also possible in both RRCs and integrated NRCs evidenced by the fact that integrated *che* NRCs can be a part of the *pro*-form *uno*.

(i) Tom ha un violino, che era un tempo appartenuto a Heifetz, e anche Jane ne ha uno.
 T. has a violin that was a time belonged to H. and also J. it has one
 ‘Tom has a violin which once belonged to Heifetz, and Jane has one too.’

- (27) a. Tom has [a violin which once belonged to Heifetz]_i, and Jane has one_i too. (RRC)
 b. Tom has [a violin]_i, which once belonged to Heifetz, and Jane has one_i too. (NRC)
 (McCawley (1988: 420))

As assumed earlier, suppose that (27b) is derived under the FSQ account while (27a) involves the merger of the relative CP to its antecedent. As a result, we get (28a, b) for (27a, b), respectively.

- (28) a. RRC (27a)
 WS = [&
 <{C, {Tom, {INFL, {v*-have, {a, {violin, {which, C, once, INFL, v-belong, to, Heifetz}}}}}}}>,
 <{C, {Jane, {INFL, {v*-have, {one, too}}}}}>]
- b. NRC (27b)
 WS = [&
 <{C, {Tom, {INFL, {v*-have, {a, violin}}}}}>,
 <{which₁, {C, {which₂, {INFL, {once, v-belong, {to, Heifetz}}}}}}}>,
 <{C, {Jane, {INFL, {v*-have, {one, too}}}}}>]

Given this prediction, the contrast at stake naturally follows because the computational system can access the full NP with the RRC only in (28a), while it cannot in (28b) because the NRC and its host clause form not a constituent but a sequence. Furthermore, McCawley (1998: 450) raises a similar observation concerning VP ellipsis in NRC.

- (29) a. John sold Mary, who had offered him \$600 an ounce, a pound of gold, and Arthur did Ø too.
 (Ø = ^{OK} sell Mary a pound of gold / *sell Mary, who had offered him \$ 600 an ounce, a pound of gold)
 b. John sold a violin, which had once belonged to Nathan Milstein, to Itzhak Perlman, and Mary did Ø did too.
 (Ø = ^{OK} sell a violin to Itzhak Perlman / *sell a violin Mary, which had once belonged to Nathan Milstein to, to Itzhak Perlman)

If the reasoning for (28a, b) holds, the reason why the elliptical Vs cannot refer to the NRCs can be also derived in the same vein.

5. Conclusion and Future Prospects

In this article, I sought to demonstrate the possibility of FSQ as a computational device, primarily focusing on the question of (3a) concerning the extent to which FSQ can explain linguistic facts. I claim that non-integrated NRCs as in English can be good candidates for applying FSQ because a number of facts that seem difficult to be explained by (Pair-)MERGE of the relative CP to its antecedent can be explained under the FSQ account. Consequently, FSQ can be evidenced as a viable computational device for generating a flat sequential unit in NS. The FSQ account can shed a new light on the typology of relative constructions in terms of the details of structure building. As has been much discussed in Hayashi (2018), it is

(*uno* = un violino, che era un tempo appartenuto a Heifetz)

problematic that we have only Set-/Pair-MERGE to accommodate the syntax of relative constructions. However, if FSQ is available as well, the typology is somewhat improved, as shown in Table 2 in (30).

(30) *Table 2*

| Types of relative construction | Computational method for associating relative CP with antecedent | Structural relation of relative CP to antecedent |
|--------------------------------|------------------------------------------------------------------|--------------------------------------------------|
| (i) RRC | MERGE | Adjunction to NP |
| (ii) Integrated NRC | MERGE | Adjunction to DP |
| (iii) Non-Integrated NRC | FSQ | Flat sequential CP |
| (iv) Complement clause | MERGE | Complementation |

For future prospects, it is highly expected that the proposed account helps us reach an understanding of other appositive constructions (*cf.* Potts (2005)). I leave this issue for future research.

References

- Bianchi, Valentina. 1999. *Consequences of antisymmetry: Headed relative clauses*, Berlin, New York: Mouton de Gruyter.
- Bošković, Željko. 2019. On the coordinate structure constraint and labelling. In *WCCFL 36: Proceedings of the 36th West Coast Conference on Formal Linguistics*, eds. by Richard Stockwell, Maura O'Leary, Zhongshi Xu, and Z.L. Zhou, 71-80, MA: Cascadilla Proceedings Project.
- Bošković, Željko. 2020. On unifying the coordinate structure constraint and the adjunct condition. In *Syntactic architecture and its consequences II: Between syntax and morphology*, ed. by András Bány, Theresa Biberauer, Jamie Douglas, and Sten Vikner, 227-258, Berlin: Language Sciences Press.
- Chomsky, Noam. 2004. Beyond explanatory adequacy, In *Structures and beyond*, ed. by Adriana Belletti, 104-131, New York: Oxford University Press.
- Chomsky, Noam. 2019. Lecture at UCLA, 29-30 April, 1-2 May.
(<https://ling.auf.net/lingbuzz/005485>)
- Chomsky, Noam. 2020. Minimalism: Where are now, and where we are going, Plenary talk on the 161st Conference on the Linguistic Society of Japan, November 22nd.
(<https://www.youtube.com/watch?v=X4F9NSVVUw&t=3528s>)
- Chomsky, Noam. 2021a. Genuine Explanations, Plenary talk on the 39th West Coast Conference on Formal Linguistics.
- Chomsky, Noam. 2021b. Minimalism: Where are we now, and where can we hope to go, *Gengo Kenkyu* 160: 1-41.
- Cinque, Guglielmo. 1988. La frase relativa. In *Grande grammatica italiana di consultazione vol. 1*, ed. by Lorenzo Renzi, Giampaolo Salvi, and Anna Cardinaletti, 443-503, Bologna: Il Mulino.
- Cinque, Guglielmo. 2008. Two types of nonrestrictive relatives. In *Empirical issues in syntax and semantics vol. 7*, eds. by Olivier Bonami and Patricia Cabredo Hofherr, 99-137, Paris: CNRS.
- Cinque, Guglielmo. 2020. *The syntax of relative clauses: a unified analysis*, Cambridge: Cambridge University Press.
- Citko, Barbara. 2008. An argument against assimilating appositive relatives to coordinate structures, *Linguistic Inquiry* 39: 633-655.
- Demirdache, K. Hamida. 1991. Resumptive chains in restrictive relatives, appositives and dislocation Structures, Doctoral dissertation, MIT.
- Dubinsky, Stanley. 2006. Parasitic gaps in restrictive and appositive clauses, In *Proceedings of IATL 22*, ed. by Yehuda N. Falk, Jerusalem: Israel Association for Theoretical Linguistics.
- Emonds, E. Joseph. 1979. Appositive relatives have no properties, *Linguistic Inquiry* 2: 211-243.
- Evans, Gareth. 1980. Pronouns, *Linguistic Inquiry* 11: 337-362.
- Fabb, Nigel. 1990. The difference between English restrictive and nonrestrictive relative clauses, *Journal of Linguistics* 26: 57-78.
- Freidin, Robert. (1986) Fundamental Issues in the Theory of Binding, In *Studies in the acquisition of anaphora*, ed. by Barbara Lust, Dordrecht: Reidel.
- Gobbo, Francesca del. 2017. More appositives in heaven and earth than are dreamt of in your Linguistics, *Glossa: A Journal of General Linguistics* 2(1): 49, 1-38.

- (DOI: <https://doi.org/10.5334/gjgl.14>)
- Goto, Nobu and Toru Ishii. 2021. Multiple nominative and form sequence: A new perspective to MERGE and form set. (<https://ling.auf.net/lingbuzz/004108>)
- Hayashi, Norimasa. 2018. The derivation of non-restrictive relative clauses and their invisibilities, *English Linguistics* 35(1): 65-95.
- Hayashi, Norimasa. 2021. Form Copy-no tekiyoo-hani/joken-ni tuite [On the range and condition on Form Copy]. Paper presented at Keio Linguistics Colloquium, Keio University, August 1st.
- Heim, Irene and Angelika Kratzer. 1998. *Semantics in generative grammar*, MA: Blackwell.
- Hooper, B. Joan and Sandra A. Thompson. 1973. On the applicability of root transformations, *Linguistic Inquiry* 14: 465-497.
- Huddleston, Rodney and Geoffrey K. Pullum. 2002. *The Cambridge grammar of the English language*, Cambridge, MA: Cambridge University Press.
- Jackendoff, Ray. 1977. *X'-syntax: A study of phrase structure*, Cambridge, MA: MIT Press.
- Jespersen, Otto. 1949. *A modern English grammar on historical principles: part III*, Copenhagen: Einar Munksgaard.
- Kayne, S. Richard. 1994. *The antisymmetry of syntax*, Cambridge, MA: MIT Press.
- Kempson, Ruth. 2003. Nonrestrictive relatives and growth of logical form, In *WCCFL 22: Proceedings of the 22nd West Coast Conference on Formal Linguistics*, eds. by Gina Garding and Mimura Tsujimura, 301-314, MA: Cascadia.
- Koev, Todor. 2013. Apposition and the structure of discourse, Doctoral dissertation, Rutgers University.
- Loock, Rudy. 2007. Appositive relative clauses and their functions in discourse, *Journal of Pragmatics* 39: 336-362.
- McCawley, D. James. 1988. *The syntactic phenomena of English* (first edition), Chicago: University of Chicago Press.
- McCawley, D. James. 1998. *The Syntactic Phenomena of English* (second edition), Chicago: University of Chicago Press.
- Nakamura, Masaru and Yoshiaki Kaneko. 2002. *Eigo no shuyou koubun* [Main constructions in English grammar], Tokyo: Kaitakusha.
- Potts, Christopher. 2005. *The logic of conventional implicatures*, Oxford: Oxford University Press.
- Ross, R. John. 1967. Constraints of variables in syntax, Doctoral dissertation, MIT.
- Safir, Kenneth. 1986. Relative clauses in a theory of binding and levels, *Linguistic Inquiry* 17: 663-689.
- Sells, Peter. 1985. Restrictive and non-restrictive modification, *CSLI Report* No. 85-28, Stanford University, Center for the Study of Language and Information.
- Taraldsen, K. Tarald. 1981. The theoretical implications of a class of marked extractions, In *Theory of markedness in generative grammar*, eds. by Adriana Belletti, Luciana Brandi, and Luigi Rizzi, 475-516, Pisa: Scuola Normale Superiore.
- Thompson, A. Sandra. 1971. The deep structure of relative clauses, In *Studies on linguistic semantics*, eds. by Charles J. Fillmore and Terence D. Langendoen, 79-96, New York: Irvington.
- Vries, Mark de. 2006. The syntax of appositive relativization: On specifying coordination, false free relatives, and promotion, *Linguistic Inquiry* 37: 229-270.
- Vries, Mark de. 2012. Parenthetical main clauses – Or not?: On appositives and quasi-relatives,

In *Main clause phenomena: new horizons*, eds. by Lobke Aelbrecht, Liliane Haegaeman, and Rachel Nye, 177-201, Amsterdam: John Benjamins.

Varieties of *Tough*-Constructions and FormCopy*

Kensuke Takita¹, Masako Maeda², Taichi Nakamura³

¹Doshisha University, ²Kyushu University, ³Tohoku University

1. Introduction

The goal of this paper is two-fold: First, it is illustrated that there is a hitherto understudied type of *tough*-construction in Japanese (which we call *CP-tough*; see Oh & Takezawa 2021 as a notable exception), in addition to the rather well-known one where *tough*-predicates directly attach to verbal stems (which we call *vP-tough*; see Inoue 1978, Takezawa 1987, a.o.). In particular, it is observed that the *CP-tough* exhibits an unexpected behavior with respect to islands, unlike their *vP-tough* counterparts. Second, it is proposed that this unexpected island-insensitivity can be captured if we adopt Chomsky’s (2021) notion of FormCopy (FC), which may assign a copy relation to two identical elements created by External Merge (EM) without recourse to Internal Merge (IM).

This paper is organized as follows. In Section 2, we examine the properties of *CP-tough* through a comparison with *vP-tough*. Section 3 offers proposals and analysis of the observation concerning the island-insensitivity. Section 4 is a conclusion.

2. Observations

This section examines the syntactic properties of *CP-tough*, comparing it with *vP-tough*. It is observed that they virtually share all the properties, but they exhibit a crucial difference with respect to the island-effects.

(1a) is a typical instance of the *tough*-constructions in Japanese (see Inoue 1976, 1978, 2004, Montalbetti, Saito & Travis 1982, Saito 1982, Kuroda 1987, Takezawa 1987, a.o.), where a class of *tough*-adjectives like *-niku* ‘tough’ and *-yasu* ‘easy’ take a *vP*-complement headed by a verbal stem (i.e. *yom(-i)* ‘read’).¹ On the other hand, in (1b) another class of *tough*-adjectives like *muzukasi* ‘tough’ and *yasasi* ‘easy’ takes a *CP*-complement headed by *no* and accompanied with the nominative Case-marker *ga*. Note also that the verb in the *CP* takes the tensed form (i.e. *yom-u* ‘read’).

* An earlier version of this paper was presented at Workshop “Explanatory Theory of UG to Satisfy Strong Minimalist Thesis: Its Contours and Conceptual Basis,” held at the 39th Annual Meeting of The English Linguistic Society of Japan (online), November 2021. We would like to thank the participants, especially Hironobu Kasai, Hisatsugu Kitahara, Masayuki Komachi, Koichi Otaki, and Asako Uchibori for their helpful comments and discussions. We also thank the audience at GLOW in Asia XIII, especially C.-T. Jim Huang and Mamoru Saito for their comments and questions, and the Organizing Committee for allowing this paper to be included in the online proceedings. All errors are of course ours. This research is supported in part by JSPS KAKENHI Grant Numbers 18K00659 given to Kensuke Takita, 18K12412, 21K00586 (PI: Nobuaki Nishioka), 18K00574 (PI: Yoichi Miyamoto) given to Masako Maeda, and 21K00568 given to Taichi Nakamura, Masako Maeda is also supported by the JSPS Core-to-Core Program, A. Advanced Research Networks “International Research Network for the Human Language Faculty” JPJSCAJ221702004 (PI: Yoichi Miyamoto).

¹ Inoue (1978) identifies four types of *tough*-constructions in Japanese, all of which have the form of *vP-tough*, and argues that examples like (1b) belong to what she calls Type I (see also Inoue 2004). Following Kuroda (1987) and Takezawa (1987), among others, we take Type I as a genuine instance of *tough*-constructions, leaving it for future research to explore the properties of the *CP-tough* counterparts of the other three types.

- (1) a. Konna ronbun-ga₁ gakusei-nitotte [_{vP} hitori-de e₁ yomi]-niku/yasu-i
 this.kind paper-Nom student-for oneself-by read-tough/easy-is
 ‘This kind of paper₁ is tough/easy for students [to read e₁ by oneself].’
- b. Konna ronbun-ga₁ gakusei-nitotte [_{CP} hitori-de e₁ yomu no]-ga
 this.kind paper-Nom student-for oneself-by read C-Nom
 muzukasi/yasasi-i
 tough/easy-is
 ‘(lit.) This kind of paper₁ is tough/easy for students [that they read e₁ by oneself].’

We call the type in (1a) *vP-tough* and the one in (1b) *CP-tough*, respectively.

CP-tough and *vP-tough* share several syntactic properties. First, it is well known that *vP-tough* allows a PP to become the subject, as shown in (2a-b) (see Inoue 1978, Montalbetti, Saito & Travis 1982, Saito 1982, Kuroda 1987, Takezawa 1987, a. o.). (2c) is a *CP-tough* counterpart of (2b), showing that it also allows PP-subjects.

- (2) a. [_{PP} Kono tosyokan-kara]-ga₁ [_{vP} e₁ hon-o nusumi]-niku/yasu-i
 this library-from-Nom book-Acc steal-tough/easy-is
 ‘(lit.) [From this library]₁ is tough/easy [to steal books e₁].’
 (adapted from Montalbetti, Saito & Travis 1982:360)
- b. [_{PP} Konna ronbun-kara]-ga₁ gakusei-nitotte [_{vP} e₁ rei-o
 this.kind paper-from-Nom student-for example-Acc
 inyoosi]-niku/yasu-i
 cite-tough/easy-is
 ‘(lit.) [From this kind of paper]₁ is tough/easy for students [to cite examples e₁].’
- c. [_{PP} Konna ronbun-kara]-ga₁ gakusei-nitotte [_{CP} e₁ rei-o
 this.kind paper-from-Nom student-for example-Acc
 inyoosuru no]-ga muzukasi/yasasi-i
 cite C-Nom tough/easy-is
 ‘(lit.) [From this kind of paper]₁ is tough/easy for students [that they cite examples e₁].’

The second property has to do with long-distance dependency. As shown in (3), in *vP-tough*, NP- and PP-subjects can be linked to the gap within the complement CP embedded under the *vP*. (3a) contains an NP subject and (3b) contains a PP subject. The examples in (4) show that long-distance *CP-tough* is also possible, with both NP- and PP-subjects.

- (3) a. Konote-no zassi-ga₁ John-nitotte [_{vP} [_{CP} maituki e₁ teikikoodokusiteiru
 this.kind-Gen magazine-Nom J.-for monthly subscribe.regularly
 to] hito-ni ii]-niku/yasu-i
 that people-to say-tough/easy-is
 ‘This kind of magazine₁ is tough/easy for John [to say to other people [that he takes e₁
 regularly every month]].’
 (adapted from Takazawa 1987:195)
- b. [_{PP} Anna taipu-no zyosei-to]-ga₁ John-nitotte [_{vP} [_{CP} e₁ kekkonsite-mo-ii
 that type-Gen woman-with-Nom J.-for marry-even-good
 to] tomodati-ni ii]-niku/yasu-i
 that friend-to say-tough/easy-is
 ‘(lit.) [To that kind of woman]₁ is tough/easy for John [to say [that he may get married e₁]].’
 (adapted from Takezawa 1987:196)

- (4) a. Konote-no zassi-ga₁ John-nitotte [CP [CP maituki e₁ teikikoodokusiteiru
this.kind-Gen magazine-Nom J.-for monthly subscribe.regularly
to] hito-ni iu no]-ga muzukasi/yasasi-i
that people-to say C-Nom tough/easy-is
'This kind of magazine₁ is tough/easy for John [that he says to other people [that he takes e₁
regularly every month]].'
- b. [PP Anna taipu-no zyosei-to]-ga₁ John-nitotte [CP [CP e₁ kekkonsite-mo-ii
that type-Gen woman-with-Nom J.-for marry-even-good
to] tomodati-ni iu no]-ga muzukasi/yasasi-i
that friend-to say C-Nom tough/easy-is
'(lit.) [To that kind of woman]₁ is tough/easy for John [that he says [that he may get married
e₁]].'

The third property is related to the subject-object asymmetry found in *tough*-constructions in English. Stowell (1986) observes that unlike embedded objects, embedded subjects cannot be related to *tough*-subjects, as shown in (5).²

- (5) a. *Betsy₁ is easy [to expect [CP e₁ fixed the car]].
b. *John₁ is easy [to believe [CP e₁ kissed Mary]].
c. ??This car₁ is hard [to claim [CP Betsy fixed e₁]].
d. ??That language₁ is impossible [to say [CP Greg will learn e₁]].

In contrast, Takita & Goto (2016) observe that this subject-object asymmetry is absent in *vP-tough* in Japanese. There is no contrast between (6a), where the object gap of the embedded clause is related to the *tough*-subject, and (6b), where the subject of the embedded clause is the gap.³

- (6) a. Zibun-no₂ gakusei-ga₁ John-nitotte₂ [_{vP} [CP Mary-ga e₁ hihansita to]
self-Gen student-Nom J.-for M.-Nom criticized that
sinzi]-niku/yasu-i
believe-tough/easy-is
'(lit.) Self's₂ student₁ is tough/easy for John₂ [to believe [that Mary criticized e₁]].'

² Given the reported grammaticality of examples like (i), we assume that examples like (5c-d) are basically fine, *contra* Stowell (1986). See also Nanni (1978) and Grover (1995).

- (i) a. This book₁ is difficult [to convince people [CP that they ought to read e₁]].
(adapted from Chomsky 1981:314)
b. Mary₁ is tough for me [to believe [CP that John would ever marry e₁]].
(adapted from Kaplan & Bresnan 1982)
c. A guy like John₁ is hard [to imagine any woman [believing [she could marry e₁]].
(adapted from Hicks 2009:542)

³ Following Takita & Goto (2016), the *tough*-subjects in (6) are forced to reconstruct so as to ensure that the gaps within the embedded CP are not simply *pro*. The following example adapted from Montalbetti, Saito & Travis (1982:361) shows that *X-nitotte* 'for X' can participate in binding.

- (i) Mary-nitotte₂ John-ga₁ [_{vP} itiban e₁ zibun-no₂ kazoku-no koto-o soodansi]-yasu-i
M.-for J.-Nom most self-Gen family-Gen matter-Acc consult-easy-is
'John₁ is the easiest for Mary₂ [to consult e₁ about self's₂ family].'

- b. Zibun-no₂ gakusei-ga₁ John-nitotte₂ [_{vP} [_{CP} e₁ Mary-o hihansita to]
 self-Gen student-Nom J.-for M.-Acc criticized that
 sinzi]-niku/yasu-i
 believe-tough/easy-is
 ‘(lit.) Self’s₂ student₁ is tough/easy for John₂ [to believe [that e₁ criticized Mary]].’

The examples in (7) show that CP-*tough* does not exhibit any subject-object asymmetry either.

- (7) a. Zibun-no₂ gakusei-ga₁ John-nitotte₂ [_{CP} [_{CP} Mary-ga e₁ hihansita to]
 self-Gen student-Nom J.-for M.-Nom criticized that
 sinziru no]-ga muzukasi/yasasi-i
 believe C-Nom tough/easy-is
 ‘(lit.) Self’s₂ student₁ is tough/easy for John₂ [that he believes [that Mary criticized e₁]].’
- b. Zibun-no₂ gakusei-ga₁ John-nitotte₂ [_{CP} [_{CP} e₁ Mary-o hihansita to]
 self-Gen student-Nom J.-for M.-Acc criticized that
 sinziru no]-ga muzukasi/yasasi-i
 believe C-Nom tough/easy-is
 ‘(lit.) Self’s₂ student₁ is tough/easy for John₂ [that he believes [that e₁ criticized Mary]].’

To sum up so far, CP-*tough* shares all the major properties with vP-*tough*, despite the difference of the complement status, vP and CP. There is one striking difference, however, when it comes to the island-effects.

Let us first consider how vP-*tough* behaves with respect to islands. As shown in (8), Takezawa (1987) observes that vP-*tough* with NP-subjects is island-insensitive. The gap inside the complex NP can be associated with the matrix NP-subjects.

- (8) a. Konote-no hanzai-ga₁ keisatu-nitotte [_{vP} [[e₁ okasita] ningen]-o
 this.kind-Gen crime-Nom police-for committed man-Acc
 sagasi]-niku/yasu-i
 search.for-tough/easy-is
 ‘(lit.) This kind of crime₁ is tough/easy for the police [to search for [a man [who committed e₁]].’
 (adapted from Takezawa 1987:203)
- b. Sooiu ronbun-ga₁ watasi-nitotte [_{vP} [[e₁ kaita] gakusei]-o
 that.kind paper-Nom I-for wrote student-Acc
 hyookasi]-niku/yasu-i
 evaluate-tough/easy-is
 ‘(lit.) That kind of paper₁ is tough/easy for me [to evaluate [a student [who wrote e₁]].’
 (adapted from Takezawa 1987:203)

On the other hand, he observes that vP-*tough* with PP-subjects is island-sensitive. The ungrammaticality of (9a-b) indicates that the gaps within the island cannot be related to the matrix PP-subjects.

- (9) a. *<sub>[PP Anna taipu-no zyosei-to]-ga₁ John-nitotte [_{vP} [[_{e₁} kekkonsiteiru] otoko]-to
that type-Gen woman-with-Nom J.-for marry man-to
hanasi]-niku/yasu-i
talk-tough/easy-is
'(lit.) [_{PP} To that kind of woman]₁ is tough/easy for John [to talk to [a man [who get married
_{e₁]]].'} (adapted from Takezawa 1987:215)</sub>
- b. *<sub>[PP Sooiu kinyuukikan-kara]-ga₁ John-nitotte [_{vP} [[itumo _{e₁} okane-o
that.kind financial.agency-from-Nom J.-for always money-Acc
takusan kariteiru] hito]-o sinyoosi]-niku/yasu-i
a.lot borrow man-Acc trust-tough/easy-is
'(lit.) [_{PP} From that kind of financial agency]₁ is tough/easy for John [to trust [a person [who
always loans a lot of money _{e₁]]].'} (adapted from Takezawa 1987:216)</sub>

The contrast between (8) and (9) leads Takezawa (1987) to propose that the gaps in *vP-tough* with NP-subjects can be either *pro* or a trace, while the ones in *vP-tough* with PP-subjects always arise from (null operator) movement. His proposals can be schematized as in (10).⁴

- (10) a. NP-ga₁ X-nitotte [_{AP} ... [_{vP} ... *pro*₁ ... V-v]-niku/yasu]-i
b. NP/PP-ga₁ X-nitotte [_{AP} ... [_{vP} (Op)₁ ... *t₁* ... V-v]-niku/yasu]-i

Let us now examine the behavior of *CP-tough*. The relevant examples are given in (11) and (12). (11a) is a case of *vP-tough* with NP-subjects, and (11b) is its *CP-tough* counterpart. The fact that both of them are grammatical suggests that the *pro*-strategy depicted in (10a) is available for *CP-tough* with NP-subjects as well as *vP-tough* with NP-subjects.

- (11) a. Konna ronbun-ga₁ kyoosi-nitotte [_{vP} [[itumo _{e₁} kaku] gakusei]-o
this.kind paper-Nom teacher-for always write student-Acc
hyookasi]-niku/yasu-i
evaluate-tough/easy-is
'(lit.) This kind of paper₁ is tough/easy for teachers [to evaluate [a student [who always writes
_{e₁]]].'}
- b. Konna ronbun-ga₁ kyoosi-nitotte [_{CP} [[itumo _{e₁} kaku] gakusei]-o
this.kind paper-Nom teacher-for always write student-Acc
hyookasuru no]-ga muzukasi/yasasi-i
evaluate C-Nom tough/easy-is
'(lit.) This kind of paper₁ is tough/easy for teachers [that they evaluate [a student [who always
writes _{e₁]]].'}

What is crucial for our purpose is the contrast between (12a) and (12b). (12a) is a case of *vP-tough* with PP-subjects, and it is island-sensitive just like (9). On the other hand, its *CP-tough* counterpart in (12b) is significantly better than (12a). This suggests that *CP-tough* with PP-subjects is not island-sensitive.

⁴ The null operator Op is put in the parenthesis in (10) because it is not crucial for the current discussion if and where it appears.

- (12) a. *_[PP] Konna ronbun-kara]-ga₁ kyoosi-nitotte [_{vP} [[itumo e₁ rei-o
 this.kind paper-from-Nom teacher-for always example-Acc
 inyoosuru] gakusei]-o hyookasi]-niku/yasu-i
 cite student-Acc evaluate-tough/easy-is
 ‘(lit.) [From this kind of paper]₁ is tough/easy for teachers [to evaluate [a student [who always
 cites examples e₁]]].’
- b. _[PP] Konna ronbun-kara]-ga₁ kyoosi-nitotte [_{CP} [[itumo e₁ rei-o
 this.kind paper-from-Nom teacher-for always example-Acc
 inyoosuru] gakusei]-o hyookasuru no]-ga muzukasi/yasasi-i
 cite student-Acc evaluate C-Nom tough/easy-is
 ‘(lit.) [From this kind of paper]₁ is tough/easy for teachers [that they evaluate [a student [who
 always cites examples e₁]]].’

The same pattern can be observed even with NP-subject cases when the movement strategy depicted in (10b) is forced. Takita & Goto (2016) observe that island-effects emerge even for *vP-tough* with NP-subjects, when the NP-subjects are forced to undergo reconstruction. That is, reconstruction ensures that the gap is not *pro* but a trace. In fact, the example in (13a) is ungrammatical, whose NP-subject contains the anaphor *zibun* ‘self’ and forced to reconstruct into the position inside the complex NP island. Crucially, its CP-*tough* counterpart (13b) is grammatical, patterning with (12b).

- (13) a. *Zibun-no₂ ronbun-ga₁ kyoosi-nitotte₂ [_{vP} [[zyugyoo-de e₁ hihansita]
 self-Gen paper-Nom teacher-for class-in criticized
 gakusei]-o hyookasi]-niku/yasu-i
 student-Acc evaluate-tough/easy-is
 ‘(lit.) Self’s₂ paper₁ is tough/easy for teachers₂ [to evaluate [a student [who criticized e₁ in
 class]]].’
- b. Zibun-no₂ ronbun-ga₁ kyoosi-nitotte₂ [_{CP} [[zyugyoo-de e₁ hihansita]
 self-Gen paper-Nom teacher-for class-in criticized
 gakusei]-o hyookasuru no]-ga muzukasi/yasasi-i
 student-Acc evaluate C-Nom tough/easy-is
 ‘(lit.) Self’s₂ paper₁ is tough/easy for teachers₂ [that they evaluate [a student [who criticized e₁
 in class]]].’

The grammaticality of (13b) indicates that CP-*tough* with NP-subjects is not island-sensitive even when reconstruction is forced.

We have examined complex NP islands, but the same pattern is observed for other kinds of islands as well.⁵ The examples in (14) and (15) show this point with adjunct islands, where the gap is contained in the conditional clause headed by *nara* ‘if.’ The examples in (14) are the cases with PP-subjects and the NP-subjects in (15) are forced to reconstruct. In both cases, the *vP-tough* versions are ungrammatical but their CP-*tough* counterparts are not.

⁵ We thank an anonymous reviewer for suggesting us to check with islands other than complex NPs.

- (14) a. *_[PP] Konna ronbun-kara]-ga₁ kyoosi-nitotte _[vP] [itidodemo e₁ rei-o
 this.kind paper-from-Nom teacher-for even.just.once example-Acc
 inyoosita-nara] gakusei-o tyuuisi]-niku/yasu-i
 cited-if student-Acc warn-tough/easy-is
 ‘(lit.) [From this kind of paper]₁ is tough/easy for teachers [to warn a student [if he/she has cited examples e₁ even just once]].’
- b. _[PP] Konna ronbun-kara]-ga₁ kyoosi-nitotte _[CP] [itidodemo e₁ rei-o
 this.kind paper-from-Nom teacher-for even.just.once example-Acc
 inyoosita-nara] gakusei-o tyuuisuru no]-ga muzukasi/yasasi-i
 cited-if student-Acc warn C-Nom tough/easy-is
 ‘(lit.) [From this kind of paper]₁ is tough/easy for teachers [that they warn a student [if he/she has cited examples e₁ even just once]].’
- (15) a. *_{Zibun-no}₂ ronbun-ga₁ kyoosi-nitotte₂ _[vP] [zyugyoo-de e₁ hihansuru-nara]
 self-Gen paper-Nom teacher-for class-in criticize-if
 gakusei-o hyookasi]-niku/yasu-i
 student-Acc evaluate-tough/easy
 ‘(lit.) Self’_{s₂} paper₁ is tough/easy for teachers₂ [to evaluate a student [if he/she criticizes e₁ in class]].’
- b. _{Zibun-no}₂ ronbun-ga₁ kyoosi-nitotte₂ _[CP] [zyugyoo-de e₁ hihansuru-nara]
 self-Gen paper-Nom teacher-for class-in criticize-if
 gakusei-o hyookasuru no]-ga muzukasi/yasasi-i
 student-Acc evaluate C-Nom tough/easy-is
 ‘(lit.) Self’_{s₂} paper₁ is tough/easy for teachers₂ [that they evaluate a student [if he/she criticizes e₁ in class]].’

To summarize the discussion so far, it is observed that *CP-tough* resembles *vP-tough* in many respects while a striking difference emerges when it comes to islands. This raises an interesting and hitherto unnoticed puzzle.

3. Proposals and Analysis

The problem boils down to the following question: Given that the *pro*-strategy is not available for the NP-subject with forced reconstruction cases and the PP-subject cases, how can the gap within islands be linked to the subjects without recourse to movement/IM only in *CP-tough*? We propose that FormCopy (FC) proposed by Chomsky (2021) provides the key to the puzzle.

The quotations from Chomsky (2021) given in (16)-(17) lie behind the notion of FC. According to Chomsky (2021), a derivation is a series of states of a unique workspace updated by applying Merge, and one important property is that derivations are strictly Markovian, namely the system completely lacks memory. Hence, when there are two identical elements (called *inscription*) in a given state of workspace of a derivation, the system cannot tell whether they are created by IM or separately introduced by EM.

- (16) “The concept [of *occurrence*] is needed only when several inscriptions are taken to be occurrences of one another. The operative notion is relational. Therefore the notion *occurrence* can be eliminated in favor of a rule FormCopy (FC) assigning the relation *Copy* to certain identical inscriptions. One condition on FC is that it observe STABILITY.”(Chomsky 2021: 17)

- (17) “FC, like other operations, appropriates Σ from the third factor toolkit and operates at the phase level, keeping to MS to select an element X, then searching for a structurally identical element Y under the conditions on Σ , and assigning the relation *Copy* to $\langle X, Y \rangle$.” (Chomsky 2021: 20) (where Σ is “an operation Σ that searches LEX and WS and selects items to which O [= an operation that incorporates Σ] will apply” (Chomsky 2021: 17))

In order to assign a copy relation to these two identical inscriptions, the operation FC may apply to them, even when they are independently introduced by EM. This gives rise to the configuration called *Markovian-gaps*, which is claimed to have the property described in (18).

- (18) “FC is not subject to conditions that hold for the structure-building operation Merge. We expect, then, to find configurations subject to FC but not Merge, though at a particular stage of derivation earlier application of Merge is not detectable because of the Markovian property of derivations, which renders history of derivation inaccessible.” (Chomsky 2021: 20-21)

Let us illustrate how the framework employing FC works, taking a parasitic gap case like (19a) as a concrete example (adapted from Chomsky 2021: 35). In (19b), which is a rough structure of (19a), there are four inscriptions of *what*. In order to ensure the attested interpretation of (19a), all of them must stand in a copy relation. As for the pairs $\langle \textit{what}^1, \textit{what}^2 \rangle$ and $\langle \textit{what}^3, \textit{what}^4 \rangle$, just IM followed by FC suffices, while the pair $\langle \textit{what}^1, \textit{what}^3 \rangle$ requires more, because the *without*-clause constitutes an island, blocking IM. Chomsky (2021) then argues that FC determines that they are in a copy relation.

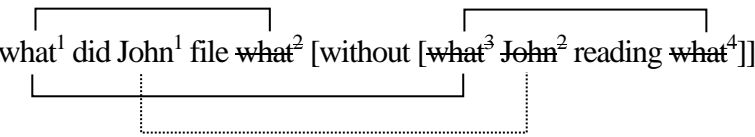
- (19) a. What did John file *e* without reading *pg*?
 b. 
 c. John¹ wrote a memoir [without John² once referring to himself]

Note that it is independently required that FC may apply across the *without*-island-boundary; otherwise the copy relation for the pair $\langle \textit{John}^1, \textit{John}^2 \rangle$ in (19b) as well as the one in (19c) fails to be established, predicting them to be ungrammatical contrary to fact.

We then propose that the *vP-tough* examples are analyzed as follows. (20a) is the structure where the *pro*-strategy is employed, where α abbreviates arbitrary many phases so as to cover the long-distance cases, and phases are given in shading. Since NP-subjects are possible no matter whether islands are involved unless they are forced to be reconstructed (see (8) and (11a)), we assume that they can make use of the *pro*-strategy, which utilizes a different mechanism from FC. The structures in (20b-c) are the cases where *vP-tough* has a PP-subject, or its NP-subject is forced to reconstruct. (20b) involves no island, so NP/PP² can be moved to the edge of *vP*-phase in a successive-cyclic way from the position of NP/PP³, yielding no problem for FC. As for the pair $\langle \textit{NP/PP}^1, \textit{NP/PP}^2 \rangle$, although there is a phase-boundary between NP/PP¹ and NP/PP², it can be licensed by FC just like the pair $\langle \textit{what}^1, \textit{what}^3 \rangle$ (and the pair $\langle \textit{John}^1, \textit{John}^2 \rangle$) in (19b) can be licensed. Hence, (20b) is legitimate.

- (22) a. Konna ronbun-ga₁ gakusei-nitotte [CP hitori-de e₁ yomu/*yonda
 this.kind paper-Nom student-for oneself-by read/have.read
 no]-ga muzukasi/yasasi-i
 C-Nom tough/easy-is
 ‘(lit.) This kind of paper₁ is tough/easy for students [that they read/have read e₁ by oneself].’
- b. [PP Konna ronbun-kara]-ga₁ gakusei-nitotte [CP e₁ rei-o
 this.kind paper-from-Nom student-for example-Acc
 inyoosuru/*inyoo-sita no]-ga muzukasi/yasasi-i
 cite/cited C-Nom tough/easy-is
 ‘(lit.) [From this kind of paper]₁ is tough/easy for students [that they cite/cited examples e₁].’

This kind of lack of tense-alternation has been taken as a hallmark of defective CP in Japanese, typically found in obligatory control structures like (23a) (Uchibori 2000, Fujii 2006, a.o.).

- (23) a. Gakusei-ga [CP PRO hitori-de konna ronbun-o yomu/*yonda to] kimeta
 student-Nom oneself-by this.kind paper-Acc read/have.read C decided
 ‘Students decided [PRO to read/have read this kind of paper by oneself].’
- b. students¹ decided [CP C [IP students² to read this kind of paper by oneself]]

In fact, Chomsky (2021) assumes that the CP complement in obligatory control is a defective phase, so that the controller-controllee pair (namely <students¹, students²>) in (23b) can be licensed by FC, even though the lower inscription *student*² is not on the CP-edge.

It is then predicted that island-effects emerge if a gap of CP-*tough* within an island is further embedded within another island. This prediction is indeed borne out, as shown by the contrast found in (24) and (25). In (24a), where the PP is the *tough*-subject, the complex NP containing the gap is the object of the most deeply embedded complement CP. Since there is no island, nothing prohibits this complex NP moves up to the edge of the defective CP, so FC can apply crossing just one island-boundary (see footnote 6). On the other hand, the complex NP containing the gap is embedded under the other complex NP headed by *riyuu* ‘reason.’ In this case, the sentence is degraded compared to (24a), indicating that it exhibits an island-effect. Under the proposed analysis, the higher complex NP island (labeled as “island₁”) blocks the movement of the lower complex NP (labeled as “island₂”) together with the gap to the edge of the defective CP. Since FC fails to apply, the ungrammaticality of (24b) follows.

- (24) a. [PP Konna ronbun-kara]-ga₁ kyoosi-nitotte [CP [CP [[itumo e₁ rei-o
 this.kind paper-from-Nom teacher-for always example-Acc
 inyoosuru] gakusei]-o hyookasita to] koohyoosuru no]-ga muzukasi/yasasi-i
 cite student-Acc evaluated that announce C-Nom tough/easy-is
 ‘(lit.) [From this kind of paper]₁ is tough/easy for teachers [that they announce [that they have evaluated [a student [who always cites examples e₁]]]].’

- b. *_{[PP Konna ronbun-kara]-ga₁ kyoosi-nitotte} _{[CP [island1 [[island2 [itumo e₁}
 this.kind paper-from-Nom teacher-for always
 rei-o inyoosuru] gakusei]-o hyookasita] riyuu]-o koohyoosuru
 example-Acc cite student-Acc evaluated reason-Acc announce
 no]-ga muzukasi/yasasi-i
 C-Nom tough/easy-is
 ‘(lit.) [From this kind of paper]₁ is tough/easy for teachers [that they announce [the reason [why
 they have evaluated [a student [who always cites examples e₁]]]]].’

The same explanation applies to the contrast found in (25), where the NP-subject is forced to reconstruct.

- (25) a. Zibun-no₂ ronbun-ga₁ kyoosi-nitotte₂ _{[CP [CP [[zyugyoo-de e₁ hihansita]}
 self-Gen paper-Nom teacher-for class-in criticized
 gakusei]-o hyookasita to] koohyoosuru no]-ga muzukasi/yasasi-i
 student-Acc evaluated that announce C-Nom tough/easy-is
 ‘(lit.) Self’_{s2} paper₁ is tough/easy for teachers₂ [that they announce [that they evaluated [a
 student [who criticized e₁ in class]]]]].’
 b. *Zibun-no₂ ronbun-ga₁ kyoosi-nitotte₂ _{[CP [island1 [[island2 [zyugyoo-de e₁}
 self-Gen paper-Nom teacher-for class-in
 hihansita] gakusei]-o hyookasita] riyuu]-o koohyoosuru no]-ga
 criticized student-Acc evaluated reason-Acc announce C-Nom
 muzukasi/yasasi-i
 tough/easy-is
 ‘(lit.) Self’_{s2} paper₁ is tough/easy for teachers₂ [that they announce [the reason [why they
 evaluated [a student [who criticized e₁ in class]]]]].’

The observations in (24) and (25) provide a clear parallelism with parasitic gaps. It is well-known that island-effects show up when the adjunct containing a parasitic gap is further embedded under another island, as shown in (26a) (see Kayne 1983, Chomsky 1986, Nunes 2001, 2004, a.o.). Under the current framework, the effect should be captured in the way depicted in (26b) (adapted from Nunes 2001: 327).

- (26) a. *Which book did you borrow *e* after leaving the bookstore without finding *pg*?
 b.

| | | | | | | | |
|-------------------|----------------|-------------------|--------------------------------------|------------------|-------------------|---------|---------------------|
| w.b. ¹ | did you borrow | w.b. ² | [island1 after leaving the bookstore | [island2 without | w.b. ³ | finding | w.b. ⁴] |
| *FC | | | | | | | |

That is, FC fails to apply from *which book*¹ to *which book*³ because of the higher island (namely island₁).

4. Concluding Remarks

To conclude, it is observed that there is a striking difference between *vP-tough* and *CP-tough* with respect to island-effects, although they are quite similar in other properties. It is then proposed that the observation regarding island-effects can be captured by employing Chomsky’s (2021) notion of FormCopy (FC), including a surprising parallelism with

obligatory control and parasitic gaps. This paper thus contributes to offering an empirical argument for FC, which is a direct consequence of the Markovian property of derivations, which in turn has emerged from the recent discussion on Merge and Workspace.

As a final remark, let us point out that there is one important remaining issue, which has to do with Chomsky's (2021) account of the well-known restriction on parasitic gaps that A-movement fails to license them. Assuming that "[f]rom an A-position, FC searches A-positions (Chomsky 2021: 28, Proposition [L])," the ungrammaticality of (27a) results from the failure of applying FC to the pair $\langle \textit{what}^1, \textit{what}^3 \rangle$ as shown in (27b) (the legitimate applications of FC to $\langle \textit{what}^1, \textit{what}^2 \rangle$ and $\langle \textit{what}^3, \textit{what}^4 \rangle$ are omitted).

- (27) a. *What was filed e [without John reading pg]?
 b. \textit{what}^1 was filed \textit{what}^2 [without \textit{what}^3 John reading \textit{what}^4] (adapted from Chomsky 2021: 35)
└──────────────────────────────────┘ *FC

If this is the case, a *tough*-subject must not be able to stand in the copy relation with a "null operator," which is nothing but an inscription appearing at the edge of the embedded clause under the current assumptions, as in (28b), which is the alleged underlying structure for (28a). But it is crucial for the proposed analysis of *tough*-constructions in Japanese that the *tough*-subjects can be paired with the lower inscriptions.

- (28) a. Many books₁ are easy for John to read e_1 . (adapted from Chomsky 2021, 28)
 b. many books₁ are [$\textit{many books}^2$ easy [$\textit{many books}^3$ for John to read $\textit{many books}^4$]]
└──────────────────────────────────┘ *FC

Meanwhile, Saito (2022: 171) suggests that "one can maintain the FC approach, and at the same time, abandon [L] on the assumption that improper movement is ruled out on independent grounds." Therefore, we believe that exploring a way to resolve this issue remains an important issue.

References

- Chomsky, Noam. 1981. *Lectures on government and binding*. Dordrecht: Foris.
- Chomsky, Noam. 1986. *Barriers*. Cambridge, MA: MIT Press.
- Chomsky, Noam. 2021. Minimalism: Where are we now, and where can we hope to go. *Gengo Kenkyu* 160:1-41.
- Fujii, Tomohiro. 2006. Some theoretical issues in Japanese control. Ph.D. dissertation, University of Maryland, College Park.
- Grover, Clair. 1995. Rethinking some empty categories: Missing objects and parasitic gaps in HPSG. Ph.D. dissertation, University of Essex.
- Hicks, Glyn. 2009. *Tough*-constructions and their derivation. *Linguistic Inquiry* 40:535-566.
- Inoue, Kazuko. 1976. *Henkei bunpoo-to nihongo [Transformational grammar and Japanese]*. Tokyo: Taishukan.
- Inoue, Kazuko. 1978. ‘Tough’ sentences in Japanese. In *Problems in Japanese syntax and semantics*, ed. by John Hinds and Irwin Howard, 122-154. Tokyo: Kaitakusha.
- Inoue, Kazuko. 2004. Japanese ‘tough’ sentences revisited. *Scientific approaches to Language* 3:75-111.
- Kaplan, Ronald M., and Joan Bresnan. 1982. *Lexical-functional grammar: A formal system for grammatical representation*. In *The mental representation of grammatical relations*, ed. by Joan Bresnan, 173-281. Cambridge, MA: MIT Press.
- Kayne, Richard. 1983. Connectedness. *Linguistic Inquiry* 14:223-249.
- Kuroda, S.-Y. 1987. Movement of noun phrases in Japanese. In *Issues in Japanese linguistics*, ed. by Takashi Imai and Mamoru Saito, 229-272. Dordrecht: Foris.
- Montalbetti, Mario, Mamoru Saito, and Lisa Travis. 1982. Three ways to get tough. In *Papers from the eighteenth Regional Meeting, Chicago Linguistic Society*, ed. by Kevin Tuite, Robinson Schneider, and Robert Chametzky, 348-366. Chicago: University of Chicago, Chicago Linguistic Society.
- Nanni, Deborah L. 1978. The *easy* class of adjectives in English. Doctoral dissertation, University of Massachusetts, Amherst.
- Nunes, Jairo. 2001. Sideward movement. *Linguistic Inquiry* 32:303-344.
- Nunes, Jairo. 2004. *Linearization of chains and sideward movement*. Cambridge, MA: MIT Press.
- Oh, Dandan, and Koichi Takezawa. 2021. Koto-setsu-o toru nan’izyutsugo-to kontorooru-nituite [On *tough*-predicates taking koto-clauses and control]. In *Rekishikon-kenkyuu-no gendaiteki-kadai [Contemporary issues in lexicon studies]*, ed. by Hideki Kishimoto, 25-49. Tokyo: Kurosio.
- Saito, Mamoru. 1982. Case-marking in Japanese: A preliminary study. Ms., MIT.
- Saito, Mamoru. 2022. Two notes on Copy Formation. *Nanzan Linguistics* 17:157-178.
- Stowell, Tim. 1986. Null antecedents and proper government. In *North East Linguistic Society (NELS) 16*, ed. by Stephen Berman, Jae-Woong Choe, and Joyce McDonough, 476-493. Amherst: University of Massachusetts, Graduate Linguistic Student Association.
- Takezawa, Koichi. 1987. A configurational approach to case-marking in Japanese. Ph.D. dissertation, University of Washington.
- Takita, Kensuke, and Nobu Goto. 2016. Labeling and *tough*-movement. Paper presented at the 24th Japanese/Korean Linguistics Conference Satellite Workshops, NINJAL, Tokyo, Japan, October 2016.
- Uchibori, Asako. 2000. *The syntax of subjunctive complements: Evidence from Japanese*. Ph.D. dissertation, University of Connecticut, Storrs.

Definite Expressions for Tenses: More Analogy between Pronouns and Tenses

Yusuke Yagi

University of Connecticut

1 Introduction

It has been claimed that there is an analogy between pronouns and tenses in that they can be anaphoric and bound variables (Partee, 1973; Kamp, 1979, 2017; Kratzer, 1998). This study adds one more observation to this analogy, arguing that some temporal pronouns have to be interpreted as definite descriptions, more specifically, as E-type (or d-type) pronouns (Cooper, 1979; Heim, 1990; Elbourne, 2001, 2005, a.o.). I further show that the novel data presented here poses an empirical challenge for dynamic analyses for anaphora (Kamp, 1981; Heim, 1982a; Groenendijk & Stokhof, 1991, among many others), which competes with the E-type analysis in accounting for anaphoric relation. The rest of this paper is organized as follows. Section 2 presents data and offers an analysis. Section 3 discusses an empirical challenge for dynamic analyses. Section 4 concludes. The formal detail of the analysis is laid out in Appendix.

2 Split Antecedence in Conjunction

The data point discussed in this study is represented by the English sentence in (1).

- (1) a. Alex was in a park at five, and Bill was in a station at six.
 b. Each of them got a phone call **at that time / then**.
 c. Alex got a phone call at five, and Bill got a phone call at six.

The data is an instance of split antecedence. Sentence (1b) is interpreted as (1c), which reveals that the temporal pronouns *at that time / then* are anaphoric to two different times, *at five* and *at six*. Thus, these pronouns are not interpreted as referring to the contextually salient time. There is no unique salient time in the context. Moreover, the singular morphology of *at that time* (contrary to *at these times*) suggests that the pronoun does not refer to a plurality of times. Putting the issue into more technical terms, suppose that temporal expressions carry a referential index – *at five* carries index 1, *at six* carries index 2, for instance. Then no indexation to the temporal pronouns achieves the reading in (1c). Assigning either 1 or 2 alone does not, because the pronouns should eventually refer to both *at five* and *at six*. However, assigning both 1 and 2 goes against the singular morphology of *at that time*, hence unwelcome.

It is important to notice that the interpretation hinges on the quantifier in the subject position of (1b). The interpretation disappears if the quantifier is replaced by *them*.

- (2) (After (1a))
 a. They got a phone call **at that time / then**.
 b. Not: Alex got a phone call at five, and Bill got a phone call at six.

I argue that the interpretation in (1) and its unavailability in (2) are accounted for by adopting the E-type strategy, which I lay out in the next section.

2.1 E-type Strategy

The E-type strategy crucially employs situation semantics. I base my proposal on the formalization by Heim (1990). The basics of the formalization are as follow.

- (3) a. Propositions are properties of situations, of type $\langle s, t \rangle$, where s is a type of situations.
- b. Situations are structured w.r.t. the part-of relation \leq .
For every pair of situations s, s' , $s \leq s'$ iff $s = s'$ or s is a part of s' .
I.e., $s \leq s'$ iff $s = s'$ or s' is an extension of s .
- c. Quantifiers quantify over pairs of an individual and a *minimal situation*.
- d. Situation s is a minimal situation w.r.t. propositions p_1, \dots, p_n iff
$$s \in (p_1 \cap p_2 \cap \dots \cap p_n) \wedge \forall s'[s' \leq s \wedge s' \in (p_1 \cap p_2 \cap \dots \cap p_n) \rightarrow s = s']$$

A central claim of the E-type strategy is that pronouns are not a syntactic primitive. Rather they are decomposed into a definite determiner THE, a predicate P , and a situation variable s . Semantically, it denotes the unique individual x such that $P(x)(s)$.

- (4) Decomposition of pronoun *pro*
LF: [THE [P s]]
 $\rightarrow \iota x[P(x, s)]$

Given the above settings, the analysis accounts for the classic donkey sentence *every man who owns a donkey beats it* in the following way. Suppose the following (semi)-lexical definitions in (5). In (5c), the predicate P in *it* is specified as *donkey*, which is arguably salient in the context. Composing (5a-c) results in (6).

- (5) a. *every* $P_{e, st} Q_{e, st}$
 \rightsquigarrow For every situation s and individual x :
if s is a minimal situation such that $P(x, s)$,
then there is a situation s' such that $s \leq s' \wedge Q(x, s')$.
- b. *man who owns a donkey*
 $\rightsquigarrow \lambda x_e. \lambda s_s. \exists y[\text{man}(x, s) \wedge \text{own}(x, y, s) \wedge \text{donkey}(y, s)]$
- c. *beats it* LF: beats [THE [donkey s]]
 $\rightsquigarrow \lambda x_e. \lambda s_s. \text{beat}(x, \iota z[\text{donkey}(z, s)])$

- (6) *Every man who owns a donkey beats it*
 \rightsquigarrow For every situation s and individual x :
if s is a minimal situation such that $\exists y[\text{man}(x, s) \wedge \text{own}(x, y, s) \wedge \text{donkey}(y, s)]$,
then there is a minimal situation s' such that $s \leq s' \wedge \text{beat}(x, \iota z[\text{donkey}(z, s')])$.

In (7), situation s contains one man and one donkey (and nothing else), since s is a minimal situation satisfying the restriction. s' , which is a minimal extension of s also contains the man and the donkey, plus beating relation between them. The uniqueness requirement of THE is satisfied because s' contains only one donkey.

2.2 Analysis

The temporal expression in (1) talks about the times of *eventualities* (*events* or *states*)

(Davidson, 1967; Parsons, 1990, a.o.) – the eventuality of Alex being in a park holds at five, for instance. Thus, it is convenient to have *eventualities* in our system as well, in addition to situations.¹ Then we obtain definitions of the conjuncts in (1a) as (7). (7a) should be read as true iff there is an event e such that e takes place at five, and e is an event of Alex being in a park in s . (See Appendix for formal details.)

- (7) a. *Alex was in a park at 5* $\rightsquigarrow \lambda s. \exists e[\text{time}(e) = 5 \wedge \text{in_a_park}(e, A, s)]$
 b. *Bill was in a station at 6* $\rightsquigarrow \lambda s. \exists e[\text{time}(e) = 6 \wedge \text{in_a_station}(e, B, s)]$

I propose that *then / at that time* bear the LF representation in (8). It is decomposed as other E-type pronouns. Since these pronouns are lexically specified as temporal pronouns, they inherently contain the TIME predicate. These temporal pronouns modify sentences as *at five/at six* do above. Thus, the scope of *each* in (1) is defined as (9), where i is a variable for times.

- (8) *at that time / then*
 LF: [THE [TIME s]]

- (9) *got a phone call then*
 $\rightsquigarrow \lambda x. \lambda s. \exists e[\text{got_a_phone_call}(e, x, s) \wedge \text{time}(e) = i[\text{time}(s) = i]]$

The quantifier in question *each* is defined as other quantifiers: it quantifies over situations and individual. The domain of individual quantification is provided by *of them*, which I for now take a set of individuals, for simplicity. The domain of situation quantification C is provided by a context (von Stechow, 1994). In the case at hand the domain is restricted to $p_1 \cup p_2$, where p_1 is (7a) and p_2 , (7b). I define *each* as follow.

- (10) *each_C of them* $Q_{e,st}$
 \rightsquigarrow For every individual x in *them* and for every situation $s \in C$:
 if x exists in s and s is a minimal situation such that $s \in C$,
 then there is a minimal situation s' such that $s \leq s' \wedge Q(x, s')$

Combining (9) and (10) results in (11).

- (11) *each_C of them* $Q_{e,st}$
 \rightsquigarrow For every individual x in *them* and for every situation $s \in C$:
 if x exists in s and s is a minimal situation such that $s \in C$,
 then there is a minimal situation s' such that
 $s \leq s' \wedge \exists e[\text{got_a_phone_call}(e, x, s') \wedge \text{time}(e) = i[\text{time}(s') = i]]$

Since the quantification is over minimal situations, the quantified situations contain *either* Alex being in a park or Bill being in a station, but not both. Still, the restriction *if x exists in s* is required to prevent overgeneration. Without it, *each* quantifies over pairs $\langle a, s_a \rangle$, $\langle a, s_b \rangle$, $\langle b, s_b \rangle$, and $\langle b, s_a \rangle$, where a is Alex, b Bob, s_a a minimal situation of (7a), s_b a minimal situation of (7b). But then scope also requires that there should be s' where *Bill* got a phone call at five, and s'

¹ The combination of event semantics and situation semantics is also argued for by Kratzer (2021).

where *Alex* got a phone call at six. This is not a reading available in (1b). The existence restriction limits the quantification to be over pairs $\langle a, s_a \rangle$ and $\langle b, s_b \rangle$, avoiding this issue.

The scope requires that the time of event e is *the* time of situation s' . s' is a minimal extension of situation s . s is a minimal situation that contains an event(uality) taking place at five or six. I thus argue that the time of s is also at five or six, unless specified otherwise by temporal modifiers. Then the time of minimally extended situation s' should also be at five or six. It in turn requires that the time of event e be at five or six, deriving the intuitively correct interpretation.

The unavailability of the reading without a quantifier is also accounted for. It is obvious that the reading hinges on the quantification over minimal situations. Since *they* does not induce the necessary quantification, the reading becomes unavailable.

Summarizing this section, I have argued that the decomposition of the temporal pronouns plus the E-type strategy derives the interpretation of (1b).

3 Discussion: E-type analysis v.s. Dynamic Analysis

In this section I argue that the interpretation of (1b) poses an empirical challenge for dynamic analyses (Kamp, 1981; Heim, 1982b; Groenendijk & Stokhof, 1991, a.o.).

Dynamic systems analyze sentences as an instruction to update an assignment. More technically, sentences are considered as pairs of an input assignment and an output assignment, the latter of which is a result of updating the input assignment along with the instruction given by the sentence. Indefinite NPs are no longer taken as quantificational expressions. They introduce what is called *discourse referents*; *drefs*, to which an assignment assigns a certain object. Drefs introduced are specified as a superscript of NPs, and an introduction of drefs instruct to update the input assignment in a certain way, as exemplified in (12).

- (12) A^u man came.
 $\rightsquigarrow \lambda i.\lambda j. i[u]j \wedge \text{man}(j(u)) \wedge \text{came}(j(u))$, where
 a. $i[u]j$ should be read as ‘ j differs from i at most the value assign to u ’.
 I.e., for all v : if $v \neq u$ then $i(v) = j(v)$

Here, the sentence updates the assignment i to j so that (j differs from i at most in the value it assigns to u and) j assigns u an individual x such that x is a man and x came. This new assignment j will in turn become an input to the next sentence, for example, in (13). Since (13) does not contain an indefinite or a proper noun, it does not update the input assignment (as specified in $j = h$), but it *tests* if the input assignment satisfies a new requirement, namely that j assigns u an individual x who (came in and) sat down.

- (13) He_u sat down.
 $\rightsquigarrow \lambda j.\lambda h. j = h \wedge \text{sat_down}(uj)$

Suppose, following Kamp (1979, 2017), that temporal expressions like *at six* introduce discourse referents as well. Suppose further that the temporal pronouns pick up a discourse referent via coindexation. A challenge that arises when applying the system to (1b) is obvious. In sentence (14a), *at five* and *at six* should be contraindexed to pass the referential information to (14b). If they are coindexed, say as u_1 , the second expression *at six* updates the input assignment so that the output assigns u_1 the time six, losing the referential information about the

time five. But if they are conjoined, the issue pointed out in the introduction arises. The pronoun should be able to refer to both at five and at six, so u_1 or u_2 alone does not suffice. However, putting both u_1 / u_2 goes against the singular morphology of the pronoun.

- (14) a. Alex was in a park at five ^{u_1} , and Bill was in a station at six ^{u_2} .
 b. Each of them got a phone call then??

In general, as long as the conjunction in (1a) is internally dynamic, the system faces the issue just discussed. One may argue then to propose an internally non-dynamic conjunction toward an analysis. However, the interpretation in question is also available when a conjunction is clearly internally dynamic. In (15), in order for *his* to pick up a proper discourse referent (introduced by *a man*), the conjunction must be internally dynamic.

- (15) a. A man was in a park at five, his friend was in a station at six.
 b. Each of them got a phone call then.

Summarizing, I've pointed out that the interpretation of (1b) poses a challenge for dynamic analyses.

4 Concluding Remark

This study aimed at arguing that *then/at that time* is analyzed as an E-type pronoun. The proposal presents another instance of the similarity between pronouns and tenses (Partee, 1973; Kratzer, 1998). The data raises an empirical issue for dynamic analyses as well.

As a concluding remark I would like to point out an extension of the analysis and a loose end. As an extension: data parallel to (1) can be composed with different types of pronouns, like *it* or *there*, as (16). It indicates that the proposal is not construction specific. The data is robustly widespread, and the analysis accounts for the distribution. The relevance of *events* shown in Appendix is further justified by the data with an event pronoun.

- (16) a. Alex saw a monkey, and Bill saw a donkey.
 b. Each of them caught it.
- (17) a. Alex was in a park, and Bill was in a station.
 b. Each of them got a phone call there.
- (18) a. Alex caught a monkey, and Bill caught a donkey.
 b. Each of them did it quickly.

However, this is not the end of investigations of constructions like (1). As far as I know, this construction has never been discussed in the literature, and it poses further interesting questions which I currently do not have an answer for. One is that the construction induces the degradation by a crossover (Postal, 1971).

- (19) a. John saw a monkey, and Bill saw a donkey.
 b. #It kicked each of them.

Suppose that the object quantifier moves to take scope over the subject pronoun, as (20a). At LF *it* is decomposed. I follow Elbourne (2008) and assume that the predicate position is filled by DONKEY_OR_MONKEY. Then the LF is represented as (20b).

- (20) a. Each of them₁ [it kicked *t*₁]
 b. LF: Each of them₁ [[THE [DONKEY_OR_MONKEY *s*]] kicked *t*₁]

This LF does not raise any semantic anomaly. Also, it suggests one technical difficulty in analyzing crossover phenomena in E-type analyses. A widespread view of crossover phenomena is that it is the *coindexation* of the crossed-over element (here, *it*) and the trace of the moved quantifier that causes the degradation due to Binding Condition C. No such coindexation, however, is supposed in LF (20b). The application of the standard analysis seems unsuccessful.

The technical issue discussed in the previous paragraph is probably a general problem of E-type analyses. Solving this puzzle is clearly beyond the scope of this paper, and I leave it for future research.

Another empirical question is on the analysis of (21), which is similar to (1) but the former contains a quantifier in the conjuncts.²

- (21) (This camp is about fostering a sense of responsibility.)
 a. This year, every boy was assigned a cat and every girl was assigned a rabbit.
 b. Each of them had to take care of it on a daily basis.

Suppose, as above, that the quantifier *each* quantifies over minimal situations in *C*, where *C* is a set of situations where (at least) one of the conjuncts in (21) is true. Then it is obvious that the present proposal does not account for the anaphoric relation. In each minimal situation *s*, either every boy was assigned a cat, or every girl assigned a rabbit. Thus, *s* contains either every boy and their cats, or every girl and their rabbits. There is no unique rabbit or cat in these situations, so the uniqueness presupposition cannot be satisfied.

Intuitively, *each* has to quantify over each minimal 'assigning' situation, where one boy is assigned one cat or one girl is assigned one rabbit. Since the domain of quantification *C* is provided contextually, we may be able to argue that *C* is specified as such. However, this argument needs careful justification, which I leave for future work.

Appendix: Formal Detail of Situation Semantics + Event Semantics

As illustrated in the analysis, existential quantification over eventuality takes place in a low position, at least lower than the lambda abstraction over situation variables. I achieve this result by partly following Champollion (2015), who argues that verbs have existential quantification over events in it. I depart from Champollion, however, in that verbs also take their argument(s) by themselves.

For a situation semantics part, I follow Elbourne (2005) in that names like *Alex* is of type *se*. The types for other functions taking the canonical individual type *e* are also lifted accordingly. In the current proposal, then, one-place predicates *pred*₁ and two-place predicates *pred*₂ are defined as

² I appreciate an anonymous reviewer of 3rd Tsinghua Interdisciplinary Workshop on Logic, Language and Meaning for pointing

- (22) a. $pred_1 := \lambda u_{se}.\lambda f_{vt}.\lambda s_s.\exists e[\text{pred}_1(e, u(s), s) \wedge f(e)]$
 b. $pred_2 := \lambda u_{se}.\lambda u'_{se}.\lambda f_{vt}.\lambda s_s.\exists e[\text{pred}_2(e, u(s), u'(s), s) \wedge f(e)]$

Then for instance *Alex slept* is computed as

- (23) a. $slept_1 := \lambda u_{se}.\lambda f_{vt}.\lambda s_s.\exists e [\text{slept}(e, u(s), s) \wedge f(e)]$
 b. $Alex := \lambda s_s.a$
 c. $Alex\ slept \rightsquigarrow \lambda f_{vt}.\lambda s_s.\exists e [\text{slept}(e, a, s) \wedge f(e)]$

In this case the variable f is saturated by predicate `true`, which is true of any events.

- (24) a. $\text{true}((23c))$
 $\rightsquigarrow \lambda s_s.\exists e [\text{slept}(e, a, s) \wedge \text{true}(e)]$
 $\rightsquigarrow \lambda s_s.\exists e [\text{slept}(e, a, s)]$

In other case the variable f lets adverbs modify the existentially quantified event. Temporal adverb *at five*, for instance, is defined as (25), where a variable V is for the type of (26), $\langle vt, \langle s, t \rangle \rangle$, abbreviated as vt, st .

- (25) $at\ five \rightsquigarrow \lambda V_{vt, st}.\lambda f_{vt}.\lambda s_s.V(\lambda e_v.[\text{time}(e) = 5 \wedge f(e)], s)$

Combining (25) and (23c) yields (26), whose f again waits for being saturated by `true` or for another adverb to modify the event.

- (26) $at\ five((17c))$
 $\rightsquigarrow \lambda f_{vt}.\lambda s'_s. [\lambda f.\lambda s.\exists e [\text{slept}(e, a, s) \wedge f(e)]] (\lambda e_v.[\text{time}(e) = 5 \wedge f(e)], s')$
 $\rightsquigarrow \lambda f_{vt}.\lambda s'_s. \exists e [\text{slept}(e, a, s') \wedge \text{time}(e) = 5 \wedge f(e)]$

With a proper definition of *at six*, and applications of `true` the propositions in the conjunction in (1a) are translated as (27a, b).

- (27) a. $\lambda s'. \exists e [\text{in_a_park}(e, a, s') \wedge \text{time}(e) = 5]$
 b. $\lambda s. \exists e [\text{in_a_station}(e, a, s') \wedge \text{time}(e) = 6]$

The temporal pronoun is defined in a similar way, as (28).

- (28) $then/at\ that\ time \rightsquigarrow \lambda V_{vt, st}.\lambda f_{vt}.\lambda s_s.V(\lambda e_v.[\text{time}(e) = i][\text{time}(s) = i]], s)$

For ease of discussion, I assume that in (1b) *each of them* undergoes quantifier raising, yielding the LF structure in (29).

- (29) [(ii) Each of them [(i) [t_1 got a phone call] [then]]]

The constituent (i), with Lambda Abstraction over the variable/trace t_1 induced by the QR, is interpreted as (30). Since `got_a_phone_call` takes the lifted individual type se , I

argue that the QR induces lambda abstraction over *se*-type.

$$(30) \quad \lambda u_{se} . \lambda f_{vt} . \lambda s_s . \exists e [\text{got_a_phone_call}(e, u(s), s) \wedge \text{time}(e) = i[\text{time}(s) = i] \wedge f(e)]$$

Each, which should take (30) as its scope, is defined as follow, where the variable Q is for the type of (30), $\langle se, \langle vt, \langle s, t \rangle \rangle \rangle$.

$$(31) \quad \begin{aligned} & \textit{each} \\ & \rightarrow \lambda u_{st} . \lambda C_{st} . \lambda Q . \lambda s_s . \forall u \forall s' \in C \\ & \quad [u'(s') <_e u(s) \wedge \text{exist}(u'(s'), s') \wedge s' \in \text{Min}(C) \wedge s' \leq s] \\ & \quad \rightarrow \exists s'' [s'' \leq s \wedge s' \leq s'' \wedge Q(u', \text{true}, s'')] \end{aligned}$$

I take the domain of individual D_e contains plural individuals, which is formed from atomic individuals by summation \oplus (Link, 1983, a.o.). The first argument of *each*, namely u' , takes a situation s and returns a plural individual. This serves as the domain of individual quantification. The argument is saturated by *them*, which I simply define as (32) in the case at hand where *them* refers to the plurality of Alex and Bill.³

$$(32) \quad \textit{them} \rightsquigarrow \lambda s_s . a \oplus b$$

Notice that while u' is evaluated w.r.t. s' , which is a minimal situation in C , u' is evaluated w.r.t. s . This is because s' does not contain such a plural individual, for its minimality. The argument u' then restricts the quantification over u' via the part-of relation $<_e$. $y <_e x$ holds iff x and y are individuals and y is an atomic part of x . Thus, the quantification over u' is restricted so that $u'(s)$ is a part of $u(s)$. The second argument C is a set of situations, the domain of situation quantification provided by context. The third argument Q is the scope of quantification.

Composing (31) and (32) yields (33), deriving the interpretation we have been pursuing. Suppose that *of them* denotes $a \oplus b$, and $C = (27a) \cup (27b)$.

$$(33) \quad \begin{aligned} & \textit{each}c \textit{ of them got a phone call then} \\ & \rightarrow \lambda s_s . \forall u \forall s' \in C \\ & \quad [u'(s') \leq_e a \oplus b \wedge \text{exist}(y, s') \wedge s' \in \text{Min}(C) \wedge s' \leq s] \\ & \quad \rightarrow \exists s'' [s'' \leq s \wedge s' \leq s'' \wedge \\ & \quad \exists e [\text{got_a_phone_call}(e, u'(s''), s'') \wedge \text{time}(e) = i[\text{time}(s'') = i]]] \end{aligned}$$

³ In a fully generalized E-type theory, *them* should be decomposed as *then* in this study, and picks up *Alex* and *Bill* through the interplay of the definite determiner and a predicate. I leave the formalization of this process for future research.

References

- Champollion, L. (2015). The interaction of compositional semantics and event semantics. *Linguistics and Philosophy*, 38(1), 31–66.
- Cooper, R. (1979). The interpretation of pronouns. In F. Heny & H. Schnelle (Eds.), *Syntax and Semantics 10: Selection from the Third Gröninggen Round Table*, 61–92. New York: Academic Press.
- Davidson, D. (1967). The logical form of action sentences. In N. Rescher (Ed.), *The Logic of Decision and Action*, 81–94. Pittsburgh: University of Pittsburgh Press.
- Elbourne, P. (2001). E-Type anaphora as NP-deletion. *Natural Language Semantics*, 9(3), 241–288.
- Elbourne, P. (2005). *Situations and individuals*. MIT Press.
- Elbourne, P. (2008). Ellipsis sites as definite descriptions. *Linguistic Inquiry*, 39(2), 191–220. Publisher: The MIT Press.
- von Fintel, K. (1994). *Restrictions on quantifier domains*. PhD thesis, UMass, Amherst.
- Groenendijk, J. & Stokhof, M. (1991). Dynamic predicate logic. *Linguistics and Philosophy* 14(1), 39–100. Publisher: Springer.
- Heim, I. (1982). *The semantics of definite and indefinite noun phrases*. PhD thesis, UMass Amherst.
- Heim, I. (1990). E-Type pronouns and donkey anaphora. *Linguistics and Philosophy*, 13(2), 137–177. Publisher: Springer.
- Kamp, H. (1979). Events, instants and temporal reference. In *Semantics from Different Point of View* (Springer Series in Language and Communication 6) 376–417. Berlin: Springer.
- Kamp, H. (1981). A theory of truth and semantic representation. In Groenendijk, J., Janssen, T., & Stokhof, M. (Eds.), *Formal methods in the Study of Language*, 189–222. Amsterdam.
- Kamp, H. (2017). Event, discourse representations and temporal Reference. *Semantics and Pragmatics*, 10, 1–68.
- Kratzer, A. (1998). More structural analogies between pronouns and tenses. In *Proceedings of SALT VIII*, 92–110.
- Kratzer, A. (2021). Situations in natural language semantics. In E. N. Zalta (Ed.), *The Stanford Encyclopedia of Philosophy* (Winter 2021 ed.). Metaphysics Research Lab, Stanford University.
- Link, G. (1983). The Logical of Plurals and Mass Terms: A Lattice-theoretic Approach, 302–323. Berlin: de Gruyter.
- Parsons, T. (1990). *Events in the semantics of English: A study in subatomic semantics*. Cambridge, Mass.: MIT Press.
- Partee, B. (1973). Some structural analogies between tenses and pronouns in English. *Journal of Philosophy*, 70, 601–609.
- Postal, P. (1971). *Cross-over phenomena*. New York: Holt, Reinhart and Winston.

Mandarin bridging: experimental data and theoretical implications

Ziling Zhu, Dorothy Ahn

Rutgers University

1. Introduction

This project experimentally investigates the distribution and the licensing conditions of bridging in Mandarin, a classifier language. Bridging, also known as associative anaphora (Clark 1975, Hawkins 1978), is a phenomenon where a definite expression is licensed in a context that does not immediately seem to meet the uniqueness presupposition. Instead, it is licensed based on some relation established in the context. Schwarz (2009) distinguishes two types of bridging based on the nature of this relation: part-whole bridging where the entity is uniquely identified within a salient situation, and producer-product bridging where the entity is uniquely identified based on some relation to another discourse referent. He further shows that this difference is reflected in languages that distinguish between uniqueness-denoting definiteness and familiarity-denoting definiteness, with the former being used for part-whole bridging and the latter being used for producer-product bridging.

The way in which Mandarin marks definiteness has been investigated in a number of works, including Jenks (2018) and Dayal & Jiang (2021). The two studies propose different theoretical analyses of Mandarin definites and thus predict different patterns for Mandarin bridging. For example, Jenks (2018) predicts bare nouns to be used in part-whole bridging only and demonstrative descriptions to be used in producer-product bridging. Dayal & Jiang's (2021) analysis of Mandarin demonstratives, on the other hand, rules out the use of demonstratives in either type of bridging. In order to test these predictions against systematically collected data, we conducted a sentence rating task where participants were asked to rate the naturalness of the two types of bridging, varying the form of the definite noun between bare nouns (*che* 'car') and demonstrative constructions (*na-liang-che* 'that-CLASSIFIER-car').

Our results suggest that both bare nouns and demonstrative constructions are felicitous in both types of bridging in Mandarin, different from what Jenks and Dayal and Jiang would predict. Our results call for a more gradient view on Mandarin bridging, where both bare nouns and *na* constructions can semantically denote both types of definiteness but may have interactions at the pragmatic level that result in distributional differences.

This paper is organized as follows. Section 2 introduces the background, presenting the general claim on two types of bridging and zooming into the specific arguments about Mandarin bridging. In Section 3, we present our sentence rating study and discuss the results, which suggest that both bare nouns and demonstrative constructions are felicitous in both types of bridging in Mandarin. Section 4 concludes with a discussion of implications and remaining questions.

2. Background

2.1 Bridging

Bridging, or associative anaphora (Clark 1975, Hawkins 1978), is a phenomenon where a definite expression is licensed based on some relation to a context. Schwarz (2009) argues that

two types of bridging must be distinguished: **part-whole bridging** that identifies the target referent based on situational uniqueness, and **producer-product bridging** that identifies the target based on relational anaphora to another discourse referent.

In part-whole bridging as in (1a), the steering wheel can be identified because there is only one such wheel in the minimal situation that contains the driving event introduced in the first sentence. In producer-product bridging as in (1b), the relevant author can be identified assuming that there is a unique author that stands in a writing relation with the book introduced in the first sentence.

- (1) a. Jane was driving down the street. **The steering wheel** was cold. [part-whole]
 b. Jake bought a book today. **The author** is French. [producer-product]

Although English uses the definite article *the* for both cases, as shown in (1), there are languages that make morphosyntactic distinctions between uniqueness-denoting and familiarity-denoting definiteness, thus distinguishing between part-whole and producer-product bridging, respectively (Schwarz 2009, 2013, a.o.). For example, Fering uses the uniqueness-denoting *a* in part-whole bridging, and the anaphoricity-denoting *di* in producer-product bridging (Ebert 1971). German makes the same morphophonological distinction between uniqueness and familiarity in part-whole and producer-product bridging, respectively (Schwarz 2009).

In this work, we examine bridging in Mandarin, a classifier language that lacks an overt definite determiner. In the next section, we first introduce some preliminary empirical data on Mandarin definite expressions and then present two theoretical views on Mandarin bridging (Jenks 2018, Dayal and Jiang 2021).

2.2 Mandarin bridging

Mandarin does not have an overt definite article. Instead, bare nouns, which occur freely in the language, as well as demonstrative descriptions containing the demonstrative *na* and the classifier allow definite readings, as shown in (2).

- (2) a. **gou** yao guo malu.
 dog want cross road
 ‘The dog wants to cross the road.’
 b. **na-tiao-gou** yao guo malu.
 that-CL-dog want cross road
 ‘That dog wants to cross the road.’

Semantic analyses of definite bare nouns and demonstrative descriptions vary in the literature. In the rest of this section, we review two recent accounts of these definite expressions and discuss their empirical predictions.

2.2.1 Jenks (2018)

Jenks (2018) argues that the difference between a bare noun and a *na* construction aligns with the uniqueness vs. familiarity distinction made in Schwarz (2009), where uniqueness-based definiteness is expressed with bare nouns and familiarity-based definiteness is expressed with *na* constructions. Jenks discusses three observations that support the claim about Mandarin

bare nouns. First, larger-situation definites in Mandarin are expressed by bare nouns. These definites are licensed by general world knowledge. For example, in (3), the bare noun *yueliang* ‘the moon’ is licensed because their descriptive content mandates that there is a unique moon.

- (3) **Yueliang** sheng shang lai le.
 moon rise up come LE
 ‘The moon has risen.’

Second, immediate-situation definites are expressed by bare nouns. In (4), the sentence is interpreted in a specific context, where a specific individual finished a specific bowl of soup that is unique in the relevant situation. Hence, definiteness is licensed, and it is expressed by the bare noun *tang* ‘soup’.

- (4) Hufei he-wan-le **tang**.
 Hufei drink-finish-LE soup
 ‘Hufei finished the soup.’

Third and most relevant to our project, he observes that part-whole bridging is expressed by bare nouns, as in (5).

- (5) Chezi bei jingcha lanjie le yinwei mei you tiezhi zai **paizhao** shang.
 car PASS police intercept LE because NEG have sticker at license.plate on
 ‘The car was intercepted by the police because there wasn’t a sticker on the license plate.’

Jenks notes that anaphoric uses of bare nouns are much more restricted. For example, in an anaphoric context as in (6), a bare noun is infelicitous and a demonstrative construction is needed instead.

- (6) Jiaoshi li zuo-zhe yi-ge-nansheng he yi-ge-nusheng.
 classroom inside sit-PROG one-CL-boy and one-CL-girl
 Wo zuotian yudao **#(na-ge)-nansheng**.
 I yesterday meet that-CL-boy
 ‘There are a boy and a girl sitting in the classroom. I met the boy yesterday.’

Based on these observations, Jenks argues that Mandarin bare nouns carry a uniqueness-based *iota* operator, while *na* constructions carry an indexed *iota* operator, which resolves referent through anaphora. He further proposes that there is a principle that maximizes the use of index whenever possible (*Index!*), explaining why bare nouns are ruled out and *na* constructions are realized in anaphoric contexts in Mandarin. Finally, he notes that there is an exception to this generalization, which is that in subject positions, bare nouns can be anaphoric due to their topic status.

Jenks’ analysis of Mandarin bare nouns and *na* constructions make specific predictions on their distribution with respect to the two kinds of bridging. Jenks predicts that bare nouns would be reserved for part-whole bridging, while *na* constructions would be reserved for producer-product bridging. Bare nouns are predicted to be felicitous in producer-product bridging only if they appear in the subject position.

2.2.2 Dayal and Jiang (2021)

Dayal and Jiang (2021, see also Dayal 2021) argue that *na* constructions are similar to English *that*, and that both demonstratives carry an anti-uniqueness presupposition. In other words, there is another entity that meets the description outside the minimal situation in which the main predicate is evaluated. As English demonstrative *that* constructions cannot be used as anaphora in bridging, as shown in (7), Mandarin *na* constructions are ruled out for the same reason.

- (7) Mary bought a house.
 a. **The** roof needed to be replaced.
 b. #**That** roof needed to be replaced.

Moreover, Dayal and Jiang note that the antecedent noun type might play a role in Mandarin producer-product bridging. They observe the contrast in (8), noting that non-subject bare nouns can also be used in producer-product bridging. They note that this observation is in conflict with what is predicted in Jenks (2018).

- (8) a. #Paul renwei **na shou shi** hen youmei, jishi ta bu renshi **shiren**.
 Paul think that CL poem very beautiful although he NEG know poet
 ‘Paul thinks that poem is very beautiful although he doesn’t know of the poet.’
 b. Paul du-le **yi ben youqu-de shu**. Ta xiang jian **zuozhe**.
 Paul read-LE one CL interesting book he want meet author
 ‘Paul read an interesting book. He wants to meet the author.’

Dayal and Jiang thus predict the felicitousness of bare nouns in bridging contexts to be more gradient, especially based on the type of antecedent used. They, however, predict *na* constructions to be ruled out in any kind of bridging contexts because the unavailability of bridging uses is one of the main characteristics of English *that*, whose distribution they claim overlaps completely with that of *na*.

In summary, Jenks predicts the two noun types are reserved for different types of bridging and for bare nouns to only allow producer-product bridging in subject positions, while Dayal and Jiang predict that Mandarin demonstratives to be ruled out in bridging contexts altogether.

In this work, we tested the two predictions presented above to better understand the distribution of bare nouns and *na* constructions in bridging. Because the empirical claims in the two papers differ, we conducted a rating task against a larger number of Mandarin speakers, carefully manipulating the possible factors that can affect the interpretation.

3. Experiment

We conducted a sentence rating task looking at Mandarin bridging constructions. The two main factors we investigated were a) the bridging type (part-whole vs. producer-product), and b) the definite expression (bare noun vs. *na* construction). In addition to the two main independent variables, we further manipulated the antecedent type to address the effect of antecedent in bridging discussed in Dayal and Jiang (2021), as well as the syntactic position in which the definite expression occurs in the second sentence, based on Jenks’ (2018) argument that subject bare nouns allow an anaphoric reading. This section summarizes our methodology and the

results.

3.1 Stimuli

Our target stimuli contained 8 part-whole bridging and 8 product-producer bridging sentence pairs. Within each item, we manipulated the anaphor noun type (bare noun vs. demonstrative), the antecedent noun type (indefinite, bare, and demonstrative), and the syntactic position of the anaphor. Half of the stimuli involved animate nouns, while the other half had inanimate nouns. We discuss each factor in detail below.

First, bridging type included part-whole and producer-product bridging. Part-whole bridging is defined as a relation where the entity labeled as the “part” is physically contained in the entity labeled as the “whole”. Producer-product bridging is defined as a relation where the entity labeled as “product” has a one-to-one correspondence to the entity labeled as the “producer”. In order to avoid a context where both kinds of bridging might be available, we made sure that the producer-product bridging did not contain any relations where the “product” was physically contained within the “producer”. The complete list of entities are presented in (9).

(9) a. Part-whole relations:

Inanimate group: (brake, car), (roof, house), (seat, bike), (screen, laptop);

Animate group: (forehead, horse), (nose, dog), (mouth, shark), (tail, cat).

b. Producer-product relations:

Inanimate group: (key, lock), (password, account), (remote, TV), (charger, phone);

Animate group: (author, book), (painter, painting), (director, film), (speaker, presentation).

Second, we manipulated the different syntactic forms that the antecedents and anaphors may take. The antecedent was either a bare noun, such as (10a), a demonstrative construction with *na* and a classifier, such as (10b), or an indefinite noun phrase with the indefinite article *yi* ‘one’ and a classifier, such as (10c). The anaphor was either a bare noun or a demonstrative construction. Crucially, the two theories have different predictions on which noun form(s) the two types of bridging would use (Section 3.3).

(10) a. *che*

car

‘car’

[BARE]

b. *na liang che*

that CL car

‘that car’

[DEM]

c. *yi liang che*

one CL car

‘one car’

[INDEF]

Third, we varied the syntactic positions where the referents (antecedents and anaphors) appear. The syntactic positions are limited to the subject and object of a simple declarative sentence.

Finally, half of the items involved animate nouns while half of the items involved inanimate ones, as shown in the full list in (9). Previous literature consistently use inanimate

objects as part-whole bridging examples, and animate ones for producers in the narrowly defined producer-product bridging (i.e., animate producers and inanimate products). The mix-match of the two variables, (in)animacy and bridging type, in the stimuli allows us to examine whether a noun form is reserved for a certain bridging type.

We present two example target stimuli in (11): a part-whole bridging item with inanimate referents in object positions, where both the antecedent and the anaphor are bare nouns, as in (11a); a producer-product bridging item with inanimate referents in subject positions, where the antecedent is an indefinite noun phrase and the anaphor is a demonstrative construction, as in (11b).

- (11) a. qu-nian wo mai le **che**. Wo zong wangji jiancha **shache**.
 Last-year I buy asp car I always forget check brake
 ‘I bought the car last year. I always forget to check the brake.’
- b. **yi-bu-shouji** mashang jiuyao meidian-le, dan **na-ge-chongdianqi** qiahao huai-le.
 One-CL-phone soon will no.battery-LE but that-CL-charger happen.to break-LE
 ‘A phone is running out of battery, but that charger happens to be broken.’

The 16 sets of target stimuli, with the factors varied as above, resulted in a total of 96 target stimuli. Each participant only saw one variation within each stimuli set, thus seeing 16 target sentences in total. In addition to the target stimuli, we included 24 syntactically well-formed controls with semantic oddness (12a), pragmatic oddness (12b), or no linguistic violations (12c). This set of control sentences were added in order to have a more systematic understanding of what the ratings mean. Comparing the participants’ ratings of the target sentences against semantically odd, pragmatically odd, and felicitous sentences allows us to locate the target ratings against a larger set of Mandarin data, and also helps us determine whether an infelicity of a sentence is due to semantic or pragmatic violations. The details of the control stimuli can be found in Zhu and Ahn (2022).

- (12) a. Zhang Xiaoming shi ge jie-le-hun-de danshenhan, wo he ta hen shu.
 Zhang Xiaoming is CL married bachelor I and he very close
 ‘Zhang Xiaoming is a married bachelor. I’m close to him.’ [semantically odd]
- b. Zuotian xiayu de shihou xiayu le.
 yesterday rain DE time rain LE
 ‘Yesterday it was raining when it was raining.’ [pragmatically odd]
- c. Xiaoxue zhengli hao keben, jue ding jintian qu-shangxue.
 Xiaoxue organize good textbook decide today go.to.school
 ‘Xiaoxue organized the textbooks and decided to go to school today.’ [neutral]

In Zhu and Ahn (2022), we determined that an instruction asking Mandarin speakers to rate based on ‘naturalness’ best captures distinctions between semantically odd and pragmatically odd sentences. Based on this, we used the instruction shown in (13).

- (13) Qing gei juzi de ziran chengdu dafen.
 Please give sentence DE natural degree rate.
 1 fen wei zui-bu-ziran, 7 fen wei zui-ziran.
 1 point is most-not-natural 7 point is most-natural
 ‘Please rate the naturalness of the sentence(s). 1 means least natural, and 7 means most natural.’

3.2 Participants and procedure

We recruited 120 native Mandarin speakers (18-64; gender-balanced) via Prolific. Participants were redirected to a PCIbex survey, where they were asked to first provide some demographic and language background information, and then complete the sentence judgment task. Participants were compensated \$2-3 for their time.

Each participant was presented with 40 stimuli, randomized in order: 8 part-whole and 8 producer-product bridging sentences (pseudo-randomized in referent noun type, animacy, and syntactic position), as well as 24 controls. Participants were asked to rate the naturalness of these sentences on a 7-point Likert scale, as in Fig. 1.

早上起床以后，张三闻到了三点钟。

请给句子的自然程度打分，1分为最不自然，7分为最自然。

最不自然 ○ ○ ○ ○ ○ ○ ○ 最自然
 1 2 3 4 5 6 7

Figure 1: Sample question (a control item with semantic violations)

3.3 Predictions

Jenks (2018) predicts that bare nouns are reserved for part-whole bridging, while demonstratives are reserved for producer-product bridging, with the exception that bare nouns are felicitous in producer-product bridging in subject positions. Therefore, anaphor noun type would significantly change the sentence ratings under the same bridging type. Bare noun anaphors would lead to higher ratings in part-whole bridging, while demonstrative constructions would lead to higher ratings in producer-product bridging. Bare nouns in subject positions would also lead to higher ratings in producer-product bridging.

Dayal & Jiang (2021) predict that Mandarin demonstrative *na* is ruled out in bridging contexts altogether, similar to English *that*. Therefore, demonstrative constructions would lead to lower ratings in any type of bridging. In contrast, bare noun anaphors would lead to higher ratings in both part-whole and producer-product bridging contexts. Moreover, they predict that gradient differences would be observed for bare nouns in bridging contexts, when antecedent noun type varies.

3.4 Results

We fit a Cumulative Link Mixed Model in R to compare ratings in different conditions. For part-whole bridging (Fig. 2), our results showed a main effect of **animacy** ($p < 0.001$) and **syntactic position** ($p < 0.05$). In the animate group (blue bars), no significant difference was

found for either **antecedent** or **anaphor** noun type ($p > 0.1$). In the inanimate group (yellow bars), we identified a main effect of **anaphor** noun type ($p < 0.01$). Moreover, Fig. 2 (as well as Fig. 3) indicates the average ratings of controls, including semantically odd sentences (red solid line), pragmatically odd sentences (red dashed line), and neutral sentences (black line).

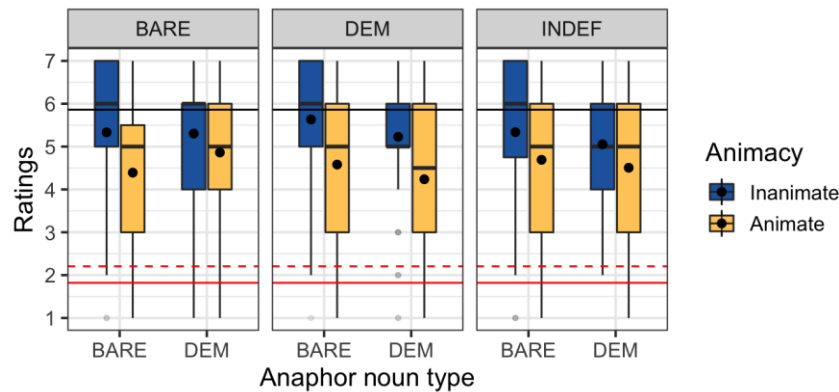

Figure 2: Ratings as function of anaphor noun type, grouped by antecedent noun type, in part-whole bridging.

For producer-product bridging (Fig. 3), we found a main effect of **syntactic positions** ($p < 0.01$) and significant interaction of antecedent noun type **INDEF** in **subject** positions ($p < 0.05$).

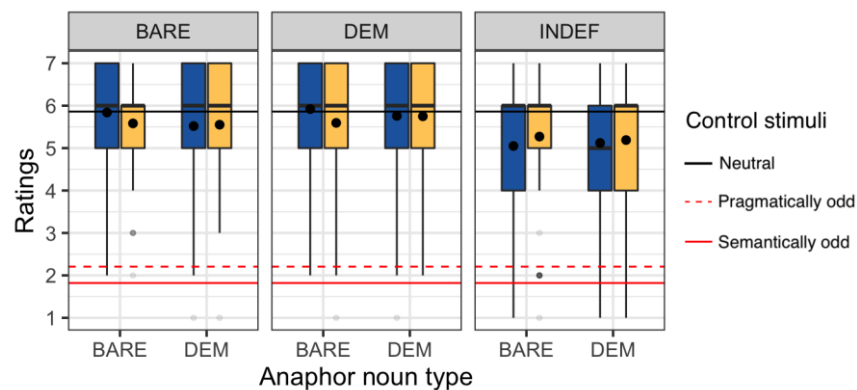

Figure 3: Ratings as function of anaphor noun type, grouped by antecedent noun type, in producer-product bridging.

For both bridging types, neither anaphor noun type nor antecedent noun type leads to significant rating differences ($p > 0.1$). Furthermore, the ratings of all bridging sentences are significantly above the ratings of pragmatically odd and semantically odd sentences ($p < 0.001$).

4. Discussion and conclusions

We have provided systematic empirical observations for Mandarin bridging. Our results show that both bare nouns and demonstrative constructions are felicitous in part-whole and producer-product bridging.

First, our results are not accounted for by Jenks' analysis. Jenks argues that demonstratives are preferred in producer-product bridging with the exception of bare nouns in subject positions. However, bare noun anaphors are actually rated higher than demonstratives in both types of

bridging. Hence, Jenks' prediction is not borne out. The only exception exists in inanimate part-whole bridging, where bare noun anaphors are indeed rated higher than demonstratives. The absence of this contrast in the animate part-whole bridging might be due to examples with body-parts such as *nose* and *forehead*. The tendency for bare nouns referring to body parts to refer to the speaker's own seems to have interfered with the rating. We suspect this might have led to the observed interaction of animacy and anaphor noun type. We plan to launch a follow-up reading time task to evaluate Jenks' theory in more depth.

Second, Dayal and Jiang (2021) makes too strong a prediction for Mandarin demonstratives, with their anti-presupposition analysis. In contrast to their prediction, Mandarin demonstrative constructions with *na* are in fact felicitous in both types of bridging, unlike English demonstratives. Moreover, the antecedent noun type did not lead to significant rating differences of bare nouns in bridging contexts. The observed interaction between indefinite antecedents and subject positions can be explained away by the dispreference of indefinite expressions in subject positions in Mandarin.

We further note that the difference between anaphor type is not categorical as predicted by Jenks' analysis. Instead, all ratings were significantly higher than pragmatically and semantically odd control sentences we included in the experiment. We argue that this calls for a more gradient view of bridging in Mandarin, where both bare nouns and *na* constructions can denote familiarity. There have been some recent discussions on the competition between different definite expressions in a given context, including definites and demonstratives (Patel-Grosz and Grosz 2017, Schlenker 2005, a.o.). These definite expressions have shown varying, gradient distributions, which are not categorical, similar to what we have observed for Mandarin bridging.

References

- Clark, H. H. 1975. Bridging. In *Theoretical issues in natural language processing*.
- Dayal, V. 2021. The Cross-linguistic Expression of Definiteness: Demonstratives, Definites and Bare Nouns. Online talk at Tsinghua University, China.
- Dayal, V., & Jiang, J. 2021. The Puzzle of Anaphoric Bare Nouns in Mandarin: A Counterpoint to Index!. *Linguistic Inquiry*, 1-42.
- Ebert, K. H. 1971. *Referenz, Sprechsituation und die bestimmten Artikel in einem nordfriesischen Dialekt* (Vol. 4). Nordfriisk Instituut.
- Hawkins, J. A. 1978. Definiteness and indefiniteness: a study in reference and grammaticality prediction. *London: Croom Helm*.
- Jenks, P. 2018. Articulated definiteness without articles. *Linguistic Inquiry*, 49(3), 501-536.
- Patel-Grosz, P., & Grosz, P. G. 2017. Revisiting pronominal typology. *Linguistic Inquiry*, 48(2), 259-297.
- Schlenker, P. 2005. Minimize restrictors!(Notes on definite descriptions, Condition C and epithets). In *Proceedings of Sinn und Bedeutung* (Vol. 9, pp. 385-416).
- Schwarz, F. 2009. Two types of definites in natural language. Doctoral dissertation, University of Massachusetts Amherst.
- Schwarz, F. 2013. Two kinds of definites cross-linguistically. *Language and Linguistics Compass*, 7(10), 534-559.

Proceedings of The 13th Generative Linguistics in The Old World in Asia (GLOW in Asia XIII) 2022 Online Special

August 4 - 7, 2022

The Chinese University of Hong Kong

Keynote Speakers

Main Session:

Željko Bošković (University of Connecticut)

Ayesha Kidwai (Jawaharlal Nehru University)

Caterina Donati (Université Paris Cité)

Rajesh Bhatt (University of Massachusetts Amherst)

Workshop: Workspace, MERGE, and Labelling

Mamoru Saito (Notre Dame Seishin University)

Hosted by

Department of Linguistics and Modern Languages

The Chinese University of Hong Kong

With the support of Faculty of Arts, The Chinese University of Hong Kong