

# 校長報告書

## Vice-Chancellor's Report

一九八七至九零年

1987-90

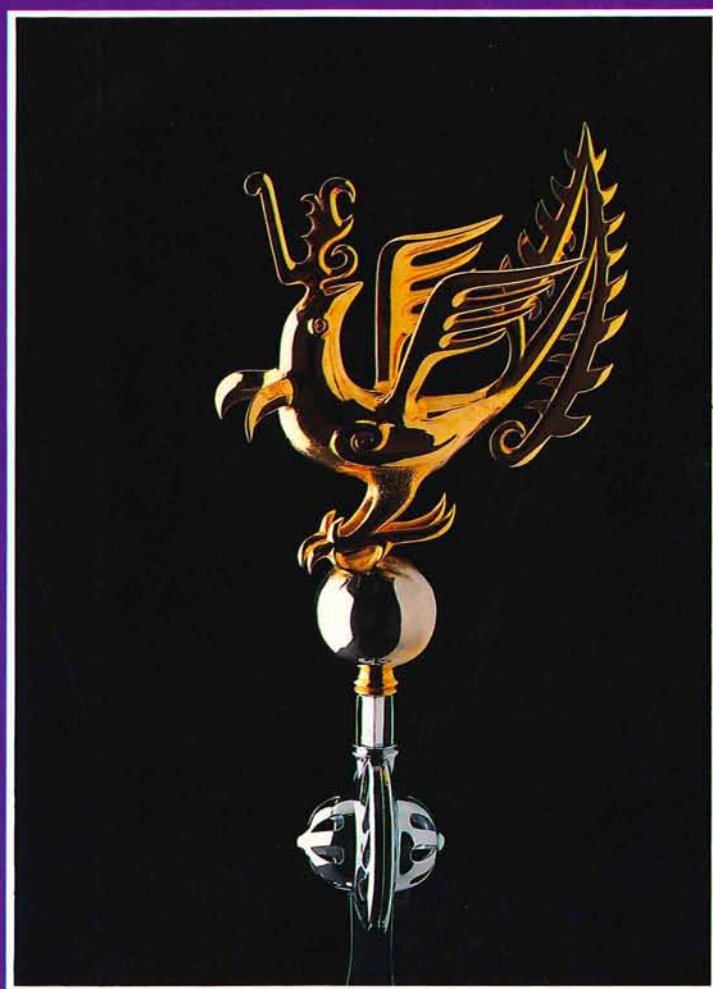

香港中文大學

The Chinese University of Hong Kong



# 校長報告書

## Vice-Chancellor's Report

一九八七至九零年

1987-90



香港中文大學

The Chinese University of Hong Kong



# 目 錄

## Contents

|  |           |
|--|-----------|
| <b>校長報告書</b><br><b>Vice-Chancellor's Report</b>                          | <b>1</b>  |
| <b>附 錄</b><br><b>Appendices</b>  | <b>27</b> |
| 1. 大學管理<br>University governance   | 29        |
| i. 大學校董會<br>The Council  | 30        |
| ii. 大學主管人員<br>University officers  | 36        |
| iii. 大學條例與規程修訂<br>Amendments to Ordinance and Statutes of the University | 40        |
| 2. 教職員資料<br>Staff information  | 43        |
| 3. 學生資料<br>Student information   | 47        |
| i. 學生人數<br>Enrolment figures   | 48        |
| ii. 入學人數<br>Admission figures  | 50        |
| iii. 修讀校外課程學生人數<br>Number of students taking extramural courses          | 52        |
| iv. 學位及文憑頒授數目<br>Number of degrees and diplomas awarded                  | 54        |
| v. 學位及文憑畢業生去向<br>Destinations of degree and diploma holders              | 56        |
| vi. 交換計劃<br>Exchange programmes  | 64        |
| vii. 宿 位<br>Hostel places  | 68        |
| 4. 校園建設<br>Campus development  | 69        |
| 5. 主要捐贈<br>Major donations   | 77        |
| 6. 賬 項<br>Annual accounts  | 89        |



校長報告書  
*Vice-Chancellor's  
Report*

## 前 言

撰寫這份報告書時，香港中文大學成立已近二十七年了，它秉持自強不息之原則，邁進九十年代。

二十多年來，中文大學一直以作育英材為己任，畢業生數以萬計。他們大部分在本港或海外位居要職，向社會貢獻一己所長，替母校樹立良好形像；而大學亦以他們之成就為榮。本校多年之努力也感召了香港各界熱心人士，他們紛紛慷慨解囊，鼎力支持中文大學。各種慈善基金捐款源源不絕，用以資助各項研究計劃。這些捐贈，不論金額多寡，都顯示出各方愛護大學之心，及支持大學辦學之意，對大學之茁壯成長，至為重要。在此，謹代表大學全體教職員生向各位社會賢達致以衷心感謝！

踏入二十世紀九十年代，先進國家之大學所充當之角色急劇轉變，它不再純粹以知識之守護神自居，而必須投身社會，成為社會不可或缺之組成部分。它必須容納大量來自不同階層背景之學生，培育大批各類人才，以應社會之需。與此同時，各國大學間必須加強連繫及交流，以維持學術水平及提高學術競爭能力。

經過八十年代之迅速發展，香港已經成為高度發展地區之一，位居全球二十個貿易強國（地區）之中；按人口平均計算之本地生產總值逐年遞升，至一九八九年已達一萬一千美元。近期本港面對勞工短缺、高通脹、可供發展土地不足、遭受東協及其他新興工業國家之強烈競爭等困難，要維持高增長，展望未來，端賴發展高科技，製造優質新產品。此外，香港已逐漸成為中國與外國交往之重要橋樑，扮演著金融中心及技術轉移中心之新角色，







## INTRODUCTION

At the time of the writing of this report, The Chinese University of Hong Kong is nearly 27 years old. It is a university on the move.

The University has over these years produced tens of thousands of graduates, many of whom are now serving society here and in communities abroad in important positions. All of them are contributing their talents and building a solid image for the University, and the University is proud of their achievements. In recognition of our efforts in producing quality graduates, many generous people of Hong Kong have been making donations in one form or another to the University. We have also received support from charitable foundations and trust funds for research. Large or small, these contributions are all important for the healthy growth of this University and are extremely useful in our quest for improvement. They exemplify a love for what this University stands for and what it does. I take this opportunity to express the gratitude of the entire University to our many benefactors.

As we enter the last decade of the 20th century, the role of universities in advanced nations is undergoing significant changes. They are not only custodians of knowledge, they also form an integral part of a global society. These universities must deal with a greater influx of students from diverse social backgrounds and must produce a range of graduates with competence in a variety of areas to meet societal needs. International linkages and the transferability of experience are also emphasized as keys to the maintenance of academic standards and competitiveness.

Hong Kong has already reached the status of a highly developed area, being ranked amongst the world's top 20 trading nations, and with its per capita GDP reaching US\$11,000 in 1989 and growing at a rapid annual rate. However, in the face of a labour shortage, high inflation, scarcity of available land and tough competition from ASEAN countries and other newly industrialized economies, the future of Hong Kong's economy depends upon its ability to shift to higher value-added products through the application of advanced technology. On the one hand, Hong Kong is moving towards new economic roles as both a financial centre

需要大量人才。近年來專業及管理人才外流情況嚴重，對本港各行各業構成一定之困擾。在這樣的經濟氣候及社會境況下，本港之大學教育實任重而道遠。

香港政府已表明將大幅擴展專上教育，增加學術研究撥款。為配合這種新形勢，中文大學必須進行種種改革，以提高整體運作效率，激勵大學師生爭取卓越成績，躋身世界一流水準學府。

其實，本人就任中文大學校長之時，大學在全體教職員生之努力下，已取得良好成績；前任校長李卓敏教授及馬臨教授竭心盡力，高瞻遠矚之領導，居功至偉。早在一九八六年，大學已為應付日後之轉變作積極準備，全面採用學分制，取代沿用之學位試制度，令大學課程可以靈活變通，以配合各方面之發展。在今天這個知識爆炸的年代，此項轉變尤其重要。本人自八七年中上任以來，曾在大大小小不同場合，與各級同人及學生接觸，就各項校政進行廣泛而深入之諮詢及交流。時至今日，大學各部門都已為改革準備就緒。茲將過去三年中完成之要務概述如後：

### **施行靈活學分制**

一九八六年以前，中文大學之課程結構由學位試及學分制組成。教務會於八六年接納由金耀基教授領導之課程檢討工作小組之建議，由八六至八七學年起，正式取消學位試，純粹採用學分制。實施新學分制三年後，校方在八九年二月委任專責小組作全面檢討。小組由金耀基教授擔任主席，其他成員包括廖柏偉博士及胡玲達女士。經過半年努力，小組提出一套建議，使學分制更靈活，更能配合香港未來發展之需要。

建議於九零年二月獲教務會通過，由九一至九二學年起實施。這套靈活學分制，不再規定按年晉級，而以修讀學分為基礎，同時顧及課程之廣度及深度，使學生能兼顧通識教育及學術新知。

在新學制下，不同才具之學生，可根據各自之志趣、學習進度及能力修讀各類課程；大學亦可同時取錄中六及中七學生，而中七入學者一般能以三年修畢本科課程。實施這個制度，大學更可與世界著名學府合辦課程，高成效地培訓優質人才，並能提供更多跨學科之學位課程，以及開辦更多學系。

and a technology transfer centre, and will serve as a significant interface between China and the outside world. On the other hand, the brain-drain phenomenon has caused the territory to lose a considerable number of professional and management personnel. All these factors constitute a new economic and social environment in which universities in Hong Kong are required to operate.

Fortunately, the Hong Kong Government has declared its intentions to significantly expand the tertiary education sector and to increase funding for academic research. This will certainly enhance our chance of developing into a world-class institution. It is apparent that the University must respond to the new environment by initiating changes to revitalize its operation and by providing incentives for both staff and students to achieve excellence.

When I assumed office as Vice-Chancellor three years ago, the University had already achieved much through the efforts of staff and students under the devoted and masterly guidance of my predecessors, Prof. Li Choh-Ming and Prof. Ma Lin. The preparation for change at this University had already started before I took office. The degree examination system was abolished in 1986 and a pure credit unit system was instituted immediately afterwards. They were intended to make our curriculum more responsive to change, a necessity when knowledge is expanding very rapidly. After nearly three years of broad and in-depth interaction with staff and students at many levels and on numerous formal and informal occasions, I have come to the conclusion that the stage is now set for implementing further changes. It is my duty now to give a report of some major tasks that have been completed during the last three years.

**ADOPTION OF A  
SUBSTANTIALLY  
IMPROVED CREDIT  
UNIT SYSTEM WITH NO  
YEARLY PROMOTION  
DEMARCATON**

Prior to 1986, the University's curriculum structure was based on a combination of the credit unit system and the degree examination system. Upon the recommendation of a special panel on curriculum review chaired by Prof. Ambrose Y. C. King, a new curriculum structure for the University's undergraduate studies, based entirely on the credit unit system, was adopted by the Senate in 1986, and became effective in the 1986-87 academic year.

After three years of implementation, an ad hoc Working Group on Curriculum Review consisting of Prof. Ambrose Y. C. King, Dr. P.W. Liu and Miss Linda Hu was appointed in February 1989 to review the system. The Working Group came up with a recommendation to further improve the system so as to increase its flexibility.

A substantially improved credit unit system with no yearly promotion demarcation was finally adopted by the Senate in February 1990 and will take effect from 1991-92. The new system will offer programmes of studies with flexible coverage of a wide range of subjects in suitable breadth and depth compatible with the rapid growth of knowledge and general education requirements. The system will also enable the University to establish joint courses with selected universities

## 成立新研究所

近年來，無論政府或社會大眾，都認識到研究工作對香港未來發展之重要。中文大學獲各界慷慨支持，在原有之中國文化研究所、理工研究所及社會研究所之基礎上，設立多所接受專款支持而自行管理之新研究所。它們共同之目標是在各專門之領域求取卓越之研究成果，以造福香港社會。

### 香港生物科技研究院

香港生物科技研究院獲英皇御准香港賽馬會捐贈一億七千萬港元設立，於一九八八年六月正式成立，是本港第一所非牟利之生

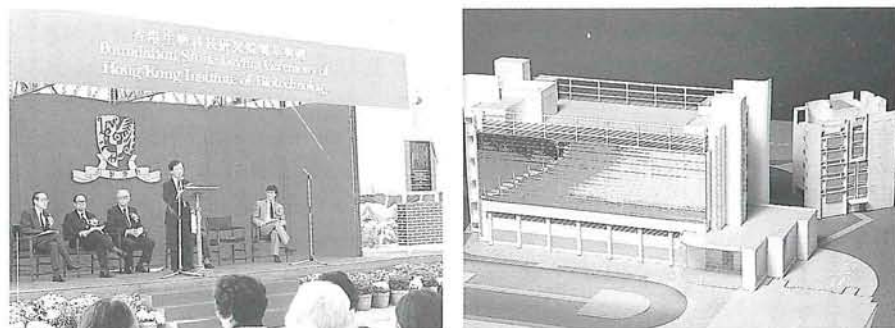

物科技研究機構。該院積極開展生物醫學研究，並將向港府及工業界提供生物科技研究之發展建議，以及透過各種合作方式，與港府及其他專上院校或商業機構共同發展本港之生物科技產品。該院之主要研究及發展範圍包括營養及食品科技、環境及廢料管理，以及東、西方藥物之研究等。

自成立以來，該院已獲數項鉅額研究資助，並與中美同類機構簽訂重要合作協議。

### 香港中文大學亞太工商研究所

亞太工商研究所於一九九零年二月成立，旨在促進學術界與工商界之交流，並為本港與海外公司提供諮詢及培訓等服務，以協助管理階層應付未來之挑戰，促進香港及亞太地區之工商貿易發展。

研究所分管理人才拓展及研究兩組，前者負責籌劃管理發展計劃、研討會及學術會議；後者則提供顧問服務，以及為研究計

around the world, to produce quality graduates at the fastest rate possible and with cost-effectiveness, to cope with the different academic attainments and aspirations of a larger number of incoming students, to offer a greater number of multi-disciplinary degree programmes, and to maintain a large number of academic departments. With the new system, the University can also accept students from both Secondary Six and Seven who will normally graduate in four and three years respectively.

#### **ESTABLISHMENT OF NEW RESEARCH INSTITUTES**

In recognition of the importance of research to the future prosperity of Hong Kong and with generous support from the Government and the community, the University has over the last three years established a number of independently funded and separately managed research institutes in addition to the existing Institute of Chinese Studies, the Institute of Science and Technology, and the Institute of Social Studies. These new institutes aspire to become centres of excellence in their own area of speciality and to contribute to the well-being of Hong Kong through their research activities.

#### **Hong Kong Institute of Biotechnology**

The institute was established in June 1988 with a donation of HK\$170 million from the Royal Hong Kong Jockey Club as a non-profit-making organization to promote the establishment of a biotechnology industry in Hong Kong. The institute conducts in-house biomedical research and collaborates with local industries, the Government, and other tertiary institutions of Hong Kong on the development of biotechnology-related projects and products. Key areas of research and development include nutrition and food technology, environmental and waste management, and Oriental and Western medicines.

Since its inception, the institute has received several substantial research grants and signed important collaborative agreements with biotechnological institutes in China and the U.S.A.

#### **Asia-Pacific Institute of Business, CUHK**

The institute was established in February 1990 to promote interaction between the academic and the business communities, to assist the management in local business enterprises to meet challenges of the future, and to enhance the growth and prosperity of Hong Kong and the Asia-Pacific region through various training, consultancy and research activities.

The institute comprises a division of management development and a division of research. The former is responsible for management development programmes and the organization of seminars and conferences, while the latter provides advisory and consultative services, and funding for research programmes and scholarly exchanges. The institute is supported primarily by private endowments and corporate sponsorship.

劃及學術交流活動籌措經費。研究所之經費來源主要靠私人捐款及商業機構贊助。

### 香港中文大學香港亞太研究所

香港亞太研究所之籌備工作已經就緒，將於一九九零年九月正式成立，取代原有之社會研究所及其轄下之兩個研究中心，即香港研究中心及當代亞洲研究中心。該所今後將致力於跨科系之社會科學研究，以期把大學發展為研究香港、中國及亞太區之學術重鎮。

研究所之研究重點包括九十年代中國之改革及發展、性別研究、香港及亞太區經濟、日本與亞太發展、亞太區之都市及區域發展、香港之政治發展、香港之社會指標與社會發展等。

為確保日後成立之研究所及新研究計劃良好運作，大學更於一九九零年三月成立一個非牟利附屬機構——「香港中文大學基金有限公司」，協助管理與發展盈虧自負之新研究單位。至於原有之研究所，如中國文化研究所及理工研究所等，則獲較多之基本資助，日後並將按其成績續予撥款作為獎勵。

## 開設新課程

過去三年，各學院增設或重組之新課程共有十四項：

### 八七至八八年度

法律副修課程  
人類學哲學碩士課程

### 八八至八九年度

訊息工程學理學士課程  
體育副修課程  
小學教育（兼讀）教育學士課程  
臨牀心理學社會科學碩士課程

### 八九至九零年度

醫學科學（增插學年）學士課程  
綜合工程學理學士課程，取代原有之訊息工程學課程  
數學及統計（兼讀）理學士課程  
體育（兼讀）教育學士課程

### The Hong Kong Institute of Asia-Pacific Studies, CUHK

The Hong Kong Institute of Asia-Pacific Studies will be formally instituted in September 1990 to replace the Institute of Social Studies and its two research centres—the Centre for Hong Kong Studies and the Centre for Contemporary Asian Studies. With its focus on multidisciplinary social science research, the institute aims to become a research and academic centre of excellence in the interrelated study of Hong Kong, China, and the Asia-Pacific region.

Research topics include reform and development of China in the 1990s, gender studies, Hong Kong and the Asia-Pacific economies, Japan and Asia-Pacific development, urban and regional development in the Asia-Pacific region, the political development of Hong Kong, social indicators and the social development of Hong Kong.

The Chinese University of Hong Kong Foundation Limited, a non-profit-making company affiliated with the University, was incorporated in March 1990 to launch and to ensure proper control of new research institutes/programmes which are expected to be self-financing in the long run. At the same time, greater baseline support and an incentive funds system have been introduced for the existing research units such as the Institute of Chinese Studies and the Institute of Science and Technology.

### NEW ACADEMIC PROGRAMMES DEVELOPED

During the period under reporting, 14 new programmes of studies were introduced or reorganized by various faculties/schools:

- |         |   |
|---------|---|
| 1987-88 | Minor programme in Law<br>M.Phil. in Anthropology   |
| 1988-89 | B.Sc. in Information Engineering<br>Minor programme in Physical Education<br>B.Ed. in Primary Education (Part-time)<br>M.S.Sc. in Clinical Psychology   |
| 1989-90 | B.Med.Sc. (an intercalated degree programme in medical sciences)<br>B.Sc. in Integrative Engineering instead of Information Engineering<br>B.Sc. in Mathematics and Statistics (Part-time)<br>B.Ed. in Physical Education (Part-time)<br>M.A. in Chinese Language and Literature<br>M.A. in Music (Composition)<br>Ph.D. in English (Comparative Literature or Applied Linguistics)<br>Ph.D. in Business Administration instead of Marketing and International Business |

Another 15 programmes have been approved for introduction in 1990-91:

- B.Sc. in Engineering instead of Integrative Engineering

中國語言及文學文學碩士課程  
音樂創作文學碩士課程  
英文哲學博士課程（比較文學或應用語言學）  
工商管理哲學博士課程，取代原有之市場與國際企業課程

另有十五項新課程已獲通過於九零至九一年度開設：

工程學理學士課程，取代原有之綜合工程學課程  
生物及化學（兼讀）理學士課程  
教育學哲學碩士課程  
教育碩士課程  
電子工程學哲學碩士課程，取代原有之電子學課程  
訊息工程學理學碩士課程  
訊息工程學哲學碩士課程  
宗教研究哲學碩士課程  
電子計算學哲學博士課程  
教育學哲學博士課程  
電子工程學哲學博士課程，取代原有之電子學課程  
地理學哲學博士課程  
訊息工程學哲學博士課程  
心理學哲學博士課程  
統計學哲學博士課程

## 拓展財政資源

自創校以來，大學有賴海內外熱心人士、工商機構及基金慷慨捐助，得以不斷發展成長，服務社會。校內眾多科研項目、教職員及學生交換計劃，以及教學設施不斷發展，都得力於社會各界之捐贈。

過去三年，大學積極拓展並成功獲取新的校外財政資源，供大學靈活調度，支持未能獲政府撥款資助之各類重要活動及發展計劃。該等資源分別來自科研合約、專業服務、安排特許權，以及顧問服務等。

## 科研合約

大學與部分本港及跨國機構訂定合約，開展特定研究項目。贊助機構依約提供研究經費或給予其他援助，但擁有優先運用研



B.Sc. in Biology and Chemistry (Part-time)  
 M.Phil. in Education  
 M.Ed. in Education  
 M.Phil. in Electronic Engineering instead of Electronics  
 M.Sc. in Information Engineering  
 M.Phil. in Information Engineering  
 M.Phil. in Religious Studies  
 Ph.D. in Computer Science  
 Ph.D. in Education  
 Ph.D. in Electronic Engineering instead of Electronics  
 Ph.D. in Geography  
 Ph.D. in Information Engineering  
 Ph.D. in Psychology  
 Ph.D. in Statistics

#### **MORE EXTERNAL FUNDING TAPPED TO SUPPORT ACTIVITIES OF THE UNIVERSITY**

Traditionally, donations and grants from local and overseas individuals, corporations and foundations have been the mainstay of external funding for the University. Such funds have supported numerous staff and student exchange programmes, research projects, the building of facilities, and the provision of much needed equipment. The University stepped up its efforts in exploring new sources of external funding in the last three years and has successfully diversified the scope and nature of external support. Such support has provided the University with the flexibility and resources to undertake projects that are important for its growth and development but which the Government is unable to finance.

#### **Contract Research**

Many local and multinational corporations have entered into contracts with the University to provide financial and other support for research projects. In return for such support to the University and its staff, these corporations will have priority use of the research findings. The University's position is that intellectual properties arising from such projects should belong to the University but the sponsoring corporations will generally be given benefits such as the right to commercialize inventions resulting from research activities.

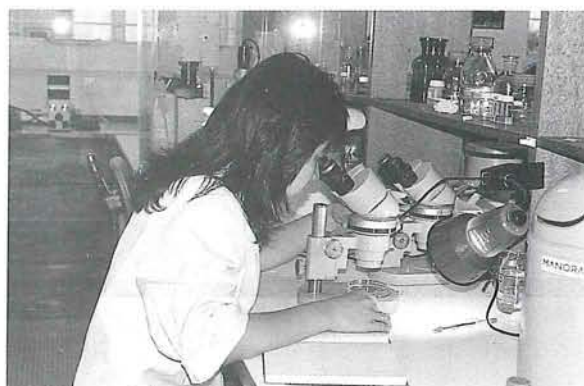



究成果之權利。大學立約原則是保留知識產權，而贊助機構則可將研究成果作商業用途。

### 專業服務

大學運用教員之專業知識，為本地工商界提供高水準之收費專業服務。大學經與一所商業機構協議，由大學提供化學品樣本，供該機構研究及發展具商業價值之產品。

### 特許權

大學教職員之研究成果，不單具備學術價值，很多更可能有商業潛能。大學已與商業機構達成特許權使用協議，由後者將大學之科技成果包裝及推廣，作商業用途；這些項目包括電算機軟件及生物科技產品等。大學所得之特許權使用費收益，將用以資助更多研究計劃，以及激勵教研人員加強研究工作。

### 顧問服務

大學鼓勵教員為工商企業提供顧問服務，以發揮個人所長，貢獻社會。教員亦可從中接觸到科技及市場之最新發展，更新教材，裨益學生，並加強大學與工商企業之聯繫。大學已於本年初修改校外服務條例，鼓勵更多教員參與顧問服務工作，為教員本身及大學增加額外收入。

## 革新校政

大學於一九八九年冬開始，檢討及重新界定學院院長、系主任及系務會之職責、職權和統屬關係。經過六個月廣泛徵詢教職同人之意見後，該項工作於九零年四月完成，從而邁出校政分權管理之重要一步，以配合大學在未來數年之迅速擴展。

根據新的職權分配，學院院長負責領導學院之整體發展，調節學院之發展方向和重點，以及處理聘任、實授、晉升及免職事務。其主要職責在於重組或增加學科，適當調配人力物力，以達成各項目標，維持學院水準。大學幾個決策組織——校董會、教務會和行政與計劃委員會——及大學校長，則負責監察和制衡學院院長之職權。

系主任負責學系之人事和管理工作，其職責包括評審人員之

### Service Provision

Capitalizing on the professional expertise of its staff members, the University has begun to provide useful services to local businesses in exchange for fees. One example is an agreement with a firm to provide samples of chemicals for commercial evaluation and to search for new, commercially viable products.

### Licensing

Results of some research activities undertaken by University staff members may benefit mankind and can have commercial value. The University has made licensing arrangements with commercial firms that will package and market certain inventions with potential commercial value. Examples include computer software and biotech inventions. It is hoped that income from royalties will in the long run fund further research and provide additional incentive for researchers to be even more productive.

### Consultancy

Faculty members have been encouraged to offer consultancy services to industries and businesses to continually update the relevancy of their teaching material, to contribute directly to the community, and to foster the University's links with the public and private sectors. The University also liberalized its outside practice regulations in early 1990 to encourage more staff members to engage in such activities which can generate more revenue for the University and bring extra income to the staff concerned.



### DECENTRALIZATION OF ACADEMIC AND ADMINISTRATIVE FUNCTIONS

An exercise to redefine the responsibility, authority and accountability of the faculty deans, department chairmen, and boards of studies was carried out in late 1989 and was completed in April 1990 after six months' wide and extensive consultation with the University's academic and administrative staff. The exercise was an important step in the process of decentralization of academic and administrative functions in anticipation of the rapid expansion of the University in the next few years.

Under the new arrangement, the responsibility of the dean lies in the overall development of the faculty. He/She has the authority to control the direction and emphasis of the faculty and his/her main concerns will include the introduction or reconstitution of subjects/areas of studies, the allocation of resources to such endeavours, and the control of quality of education through their active involvement in dealing with matters related to staff appointment, substantiation, promotion, and dismissal. The University policy bodies – the Council, Senate, and the Administrative and Planning Committee – and the Vice-Chancellor are checks and balances for the dean's authority.

The department chairman is now responsible for all personnel and

晉升、編配教務工作、控制教學質素，以及處理一般行政事務。傳統上，系主任必須肩負學科發展之責任；但在今天，各門學科不斷深入繁衍，已不可能要求一個人精通系內各門知識，並獨力領導學術發展。學術上之責任，自然便落到系務會各委員身上。

系務會由各學科主任互選主席擔任協調工作，負責制訂和實施本科生及研究生課程，就學術事務與學生保持溝通，負責新生入學、學生輔導，以及其他教學事務。

## 採用更靈活之 人事政策

未來數年，本港大專院校在羅致優秀教職人才方面之競爭將十分激烈。面對這種情況，大學採取新措施，加快聘任教職員之程序，並變通地執行聘任條件，以吸引及挽留人才。

### 精簡教職員招聘程序

大學校董會於一九八七年通過，授權根據「大學規程」第二十條而設之敘聘諮詢委員會（成員包括有關學科之校外專家），議決高級講師或以下級別之教職員之聘任事宜，縮短審批程序，以提高招聘效率。

### 靈活執行僱員服務條款

現時，甲類服務條款僱員之聘任方式，包括長職僱用、限期合約或兼任合約，並附之以如下之彈性安排：

- （一）一般一年合約（附約滿酬金），可靈活變通為十個月之合約，即連續工作十個月，期間不支取合約規定之假期，至約滿時，除獲得議定之約滿酬金外，另獲支取假期代金。
- （二）部分因工作關係而不能按合約支取議定長假之教職員，除獲基本約滿酬金外，亦可支取長假代金。
- （三）為擴闊教員之接觸面及視野，更新專業知識，教員可與大學磋商，申請兼任安排，使教員能在某段期間，放下部分大學事務；除負責正常之教學工作外，可同時受僱於校外機構，從事顧問服務等工作。兼職受僱期間之教學及其他事務比例，由各該教員與校方議定。

administrative affairs within the department. These include promotion assessment, assigning teaching duties, quality control and other administrative duties. Formerly, the department chairman was expected to be the academic leader of the field of studies offered by the department. This situation can no longer be sustained even if it is desired. The proliferation of any field of studies is so great these days that no one can be expected to be an overall expert providing academic leadership to the whole department single-handedly. The academic duties have therefore been assigned to the members of the Board of Studies.

The Board of Studies, acting as a body under the coordination of the chairman of the Board elected from among the Directors of Studies, is responsible for the design and implementation of the undergraduate and postgraduate programmes and curricula, dialogue with students on academic matters, the admission and counselling of students, and all other academic affairs.

In the face of keen competition for high-quality staff members in the next few years, the University introduced new measures to expedite the process of staff recruitment and to increase the flexibility of employment terms to attract suitable candidates:

**MORE FLEXIBLE  
PERSONNEL POLICIES  
INTRODUCED**

**Staff Recruitment Procedure Streamlined**

Approval from the University Council was sought in 1987 for authority to approve the appointment of teaching and non-teaching staff at Senior Lecturer rank or below to be delegated to the Board of Advisers (which consists, among others, of external experts in the special fields concerned) constituted under Statute 20 of the University Ordinance. This has sped up the recruitment procedure as a whole.

**Greater Flexibility in Benefit Package Introduced**

Employment terms may now take the form of superannuable, fixed-term or fractional-time contracts with the following additional flexibility:

- (i) Standard one-year gratuity-bearing contracts may be flexibly made in the form of a 10-month contract under which the appointee will be required to be in resident service for the entire 10 months, and a cash payment in lieu of the entitled leave under the standard contract will be payable at the end of the 10-month period together with the usual contract-end gratuity.
- (ii) Payment in lieu of the entitled long leave are made to academic and professional staff on contract terms whose job requirements usually prevent them from taking extended leave of absence during the contract period.
- (iii) To facilitate professional development through outside consultancy work, staff members may now negotiate with the University for a fractional-time appointment which would allow them to be employed with reduced University duties while taking up the outside consultancy employment. During the period, the staff concerned will still be required to teach. The

### 實行新長假安排

大學為方便人力規劃，並減輕因要支付教職員累積長假之代金可能造成之財政負擔，自一九九零年一月一日起，對於該日或其後入職，按甲類服務條款獲聘任之僱員，實行長假安排之新措施。前此入職之僱員，可保留舊長假安排，亦可由同一生效日期起，選擇採用新措施。

按新的長假安排，大學將逐年計算教職員在過去一年所累積而未支取之長假，並於年終支付不超過一個月之長假代金；代替過去於聘約結束時才支付未支取長假代金之計算方式。而教職員除去長假代金後在該學年所累積之其餘長假，則須於大約兩年內支取。然而教職員亦可向大學申請，以其積累不超過六個月之長假作為進修假期；惟其進修計劃必須為攻讀與其教職範圍有關之高級學位或相等資格。

### 重組大學秘書處

大學之不斷擴展，以及校務之新發展，需要新的行政及服務支援，例如加強教職員進修計劃及籌募研究經費。為使行政部門能更有效及順利地運作，大學已著手重組行政部門，清楚界定工作及職權範圍，以避免重疊及混亂。

首先重組之行政部門是大學秘書處。由九零年一月一日起，秘書處重新編整為人事組、校務組及大學發展組三大組別。重新

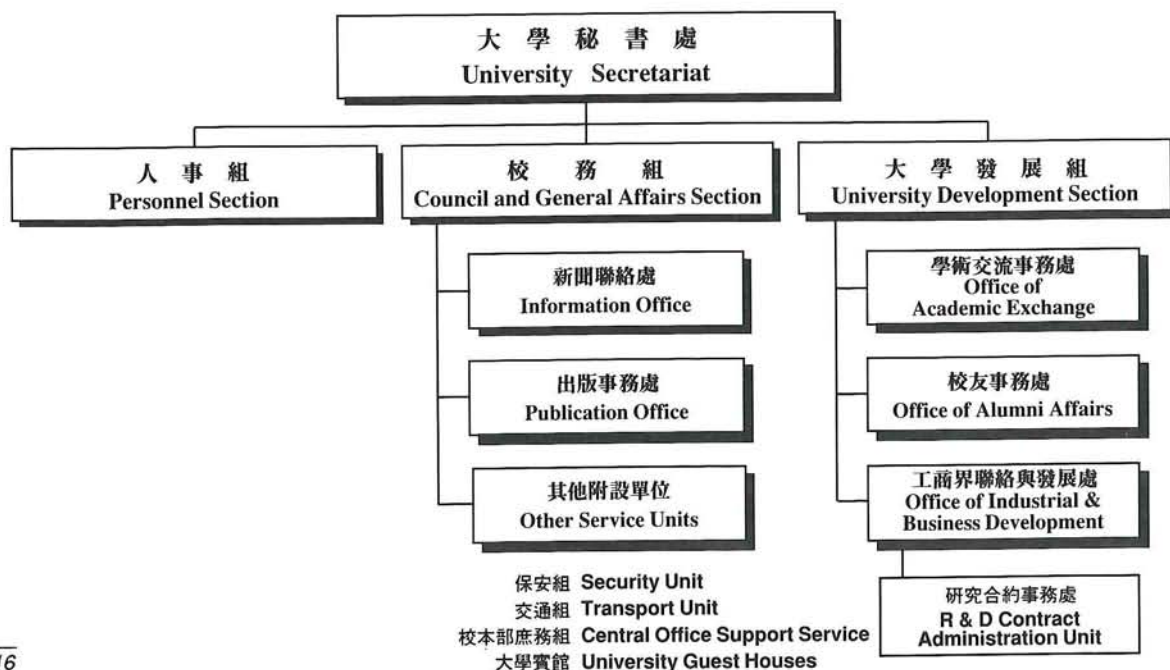

teaching load and other University duties will be set at a proportion agreeable to both the University and the staff members concerned.

### **New Long Leave Arrangements Implemented**

To facilitate manpower planning and to help the University to ease the financial burden which may arise from payment in lieu of extended accumulation of long leave, the University started to implement new long leave arrangements from 1st January 1990 for all Terms of Service (A) staff appointed on or after that date. Serving staff members on Terms of Service (A) were given the option of selecting the new arrangements from the same date.

Under the new leave arrangements, payment in lieu of any accumulated long leave up to a maximum of one month is made to all affected Terms of Service (A) staff members once every year instead of at the end of employment. The remaining long leave earned has to be cleared, broadly speaking, within a two-year period. However, staff members may, upon application, be allowed to use their accumulated long leave as study leave for a period of up to six months to pursue further studies or research leading to a higher degree or equivalent qualifications relevant to their duties.

The University's continuous growth and new thrusts in various directions have generated the need for new administrative and service support, e.g. better focused staff development programmes and fund-raising programmes to aid research. To enable the administrative units to render services more efficiently, smoothly and in good time, the administrative departments have been reorganized to be task-specific and free from double reporting.

### **REORGANIZATION OF THE UNIVERSITY SECRETARIAT**

With effect from 1st January 1990, the Secretariat has been consolidated into three distinct sections: Personnel, Council and General Affairs, and University Development. The job responsibilities, authority and accountability of the staff members at all levels have been more clearly defined to minimize the overlapping of roles and duties. The new administrative set-up has enabled each officer to discharge his/her responsibilities independently and efficiently within defined authority and to be accountable for his/her decisions and actions. Furthermore, the new system has enhanced the capability of the Secretariat and its staff to respond to changes and to maintain the quality of service as the operation grows larger.

The University Development Section is a newly established section within the Secretariat to support the expansion of the University's research and development (R & D) activities and other University development objectives through linkages and collaboration with external organizations. Through increased research activities and greater collaboration with business and public organizations, the University can enlarge its reservoir of knowledge, and in turn benefit society by transferring such knowledge to students and to the community at large. The University Development Section provides an umbrella structure for three existing

明確界定工作範圍、權力及職責，以避免重疊。重組後，單位主管在其責任範圍內，能較前更獨立地決策及有效地履行職務。新行政架構可以提高秘書處之運作效能，以應付各種轉變，並在工作日增之情況下，保持水準。

新設之大學發展組之主要任務是輔助大學拓展研究及開發活動，並通過與校外機構之聯繫與合作，協助大學達至其他發展目標。隨著大學之研究活動及與工商界和公共組織之協作日益增加，大學將積累更多知識；這些知識可以轉過來傳授與學生，並造福社會。該組由原有的三個部門合併而成：學術交流事務處、校友事務處及工商界聯絡與發展處；後者於八八年成立，並附設研究合約事務處。

## 成立逸夫書院

大學第四所成員書院——逸夫書院，於一九九零年三月二日正式揭幕，並由港督兼大學監督衛奕信爵士及書院創辦人邵逸夫爵士主持儀式。大學承蒙邵氏基金會慨捐一億一千萬港元，得以成立第四所書院；並使大學的書院制度進一步成長。中大成立以來，學生人數大幅增長，原有三所成員書院之設施已不敷應用；逸夫書院之誕生，及時配合了大學之發展。

一九八六年初，成立逸夫書院之籌備工作正式展開。八七年二月十日，精神科學系陳佳肅教授獲大學校董會委任為逸夫書院首任院長。同年六月，書院成立院務委員會，院務室人員亦相繼就任，至八八年，院務遂告全面展開。

逸夫書院建築計劃分三期進行。第一期工程已於八八年完成，包括一座可容六百名學生之宿舍，內設教職員及學生餐廳，一座康樂中心，一座教職員宿舍，以及一座教學及行政大樓，內設微型電算機室。書院之第二期工程為一座有五百座位之大講堂及更多的教職員宿舍，預計於九一至九二年竣工。第三期工程則為一座容納三百學生之宿舍。

書院每年舉行一系列月會及晚餐演講會，邀請學者演講，推行通識教育。書院為增加教職員及學生與國際知名學者交流之機會，設立多種訪問學人計劃。「邵逸夫爵士傑出訪問學人計劃」就是其中較重要者，該計劃之首屆訪問學人為諾貝爾化學獎得主李遠哲教授。





offices, namely the Office of Academic Exchange, the Office of Alumni Affairs, and the Office of Industrial and Business Development, established in 1988, which also includes an R & D Contract Administration Unit.

#### ESTABLISHMENT OF SHAW COLLEGE

The University's fourth constituent college, Shaw College, was officially opened on 2nd March 1990 by His Excellency the Governor and Chancellor of the University, Sir David Wilson, and the Patron of the College, Sir Run Run Shaw. This further enrichment of the University's collegiate system was made possible by a generous donation of HK\$110 million by the Shaw Foundation Hong Kong Ltd. The donation came at a most opportune time as the facilities of the three existing colleges had been considerably overstretched by the substantial expansion in student numbers.



Preparation work for the establishment of Shaw College began in early 1986 and Prof. C.N. Chen, professor of psychiatry, was appointed the first head of college by the University Council on 10th February 1987. With the setting up of the Assembly of Fellows in June of the same year and the completion of staffing for the College Office in 1988, Shaw College soon swung into full operation.

The construction of new facilities for Shaw College is divided into three stages. Completed in stage one in 1988 were a twin-block student hostel with 600 beds and two canteens, an amenities centre, staff quarters, and an education and administration building with a microcomputer laboratory.

Scheduled for completion in 1991 and 1992 in stage two will be a 500-seat lecture theatre complex and more staff quarters.

Construction work in the third stage will feature another student hostel that can accommodate 300 students.

Each year the College holds monthly assemblies and dinner lectures, inviting scholars to give talks on general education topics. The College has also established visiting scholar programmes to promote links and exchanges between College members and internationally renowned scholars. One of the more important programmes is the Sir Run Run Shaw Distinguished Visiting Scholar Programme which invited to the University in 1989 its first visiting scholar, Prof. Yuan-Tseh Lee, Nobel Laureate in chemistry.

## 結語

綜合言之，香港中文大學已作好準備，為香港提供靈活及高效率之優質專上教育，積極拓展與國際學術機構之連繫，努力提高大學之國際聲譽。

最後，本人借此向曾參與籌劃或執行上述各項計劃之同人致謝！

## 附錄撮要

大學過去三年之主要統計資料，已臚列在報告書附錄內，包括大學領導層之變動、教職員資料、學生人數、新生入學人數、修讀校外課程學生人數、學位及文憑畢業生資料、交換計劃及宿位數字、校園建設、主要捐贈，以及財務概況。這些統計資料，顯示大學之擴展持續不斷，也說明本校畢業生正在不同的職業崗位上服務香港社會。

### 大學管理

附錄一刊列一九八七至九零年之大學校董會成員及大學主管人員名單，以及在此期間曾經修訂之大學條例及規程。

### 教職員資料

過去三年，大學全職僱員人數從二千五百零六名增至二千七百一十九名，每年平均增幅為百分之四。各類僱員，即教學、研究、行政及專業人員之人數比例，則大致維持不變。單就教員而論，總人數由六百一十名增至六百六十三名，升幅近百分之九。

### 學生人數

期內之本科生及研究生人數，均持續穩定上升。

若以學院之本科生人數而言，過去三年，理學院一直是規模最大之學院（綜合工程學課程及暫編主修醫科課程均隸屬理學院），社會科學院緊躡其後，而工商管理學院則於一九八九至九零年度超越文學院，位居第三。

同期之研究生人數增長雖較緩，情況依然令人鼓舞。大學期望於未來三年，加速擴展研究院課程。

**CONCLUDING  
REMARKS**

To summarize, the University is now better equipped to deliver quality education flexibly and efficiently to meet the changing needs of Hong Kong and to develop itself into a first-rate academic institution with international linkages. I wish to thank all those involved in the planning and implementation of the various tasks.

**NOTES TO THE  
APPENDICES**

Key statistics which give a general picture of how the University and its students have fared over the last three years are listed in the appendices of this report; they cover changes in University leadership, staff information, student enrolment and admission figures, extramural courses, the types and number of degrees and diplomas conferred, the destinations of such degree and diploma holders, exchange programmes and hostel places, campus development information, major donations, and annual accounts. Together these statistics demonstrate a trend of expansion and show that our recent graduates have been serving the local community in large numbers and diverse occupational sectors.

*University Governance*

Appendix 1 records Council membership and University officers from 1987 to 1990 as well as amendments to the Ordinance and Statutes of the University during the period.

*Staff Information*

Statistics show that the University's full-time staff force has grown by an annual average increase of 4 per cent from 2,506 to 2,719 over the last three years. Their distribution in respect of nature of employment (ie. academic, research, administrative, or professional etc.) has remained more or less the same.

As for academic staff alone, their total number has increased by nearly 9 per cent from 610 to 663 over the three-year period.

*Student Enrolment Figures*

Both undergraduate and postgraduate enrolment figures show steady annual increases in the period.

Analysis of the enrolment of undergraduates by faculty shows that the Faculty of Science, which includes in its enrolment students of the Integrative Engineering Programme and the general science programme for Potential Medical Majors, had the biggest number of students in each of the three years. This was followed by the Faculty of Social Science. In 1989-90 the Faculty of Business Administration overtook Arts as the third largest faculty.

The continuous increase in postgraduate enrolment during the period is encouraging, as postgraduate studies is one area we hope very much to expand at a much faster rate in the next triennium.

### 新生入學人數

本科生之入學人數，八七至八八年度為一千七百三十四名，逐年增長至八九至九零年度之二千零四十五名。過往三年招收之學生，文、商、社科三學院以女生居多，醫、理學院則相反。雖然各學院之男女生比例各異，惟就總人數計算，比例仍相差不大，八九至九零年度入學之男生人數為一千零四十六名，女生為九百九十九名。由於政府經已公布在未來數年擴展專上教育，預期本校之本科及研究院課程之入學人數將顯著增加。

### 修讀校外課程學生人數

校外進修部一九八七至八八年開辦課程一千六百九十七項，八九至九零年已增至二千零七項，門類及題材甚豐，以適應廣大市民之興趣及需要。修讀這些課程之人數每年約五萬四千名，學生來自社會之各行各業。

從修讀語言、證書或文憑課程人數之不斷增長，反映了近年社會之需求。大學將隨社會需要，擴展該等課程。

### 學位及文憑畢業生

大學每年頒授各類學位及文憑予畢業生，隨後即展開應屆畢業生之就業情況調查。過去三年之調查結果顯示，中大畢業生大部分為教育界或工商界所吸納。其他僱主則包括政府和公用事業部門，以及公共及社會服務機構。

### 交換計劃及宿位

大學及其成員書院俱與海外學府訂定交換計劃，以擴闊學生之視野及豐富校園生活。比較一九八七至八八及一九八九至九零年度之數字，交換計劃之數目從八項增至十一項，而本校派出之交換生人數，則由二十五名增至三十八名。

多年來全日制本科生之宿位一直供不應求，直至一九八九年，逸夫書院一幢學生宿舍落成，大學方能在八九至九零年度讓僅逾半數學生獲得宿位。一九八七年以前，研究院宿舍可容納八成以上之全日制研究生；然研究院課程及學生之不斷增加，致使獲得

### *Student Admission Figures*

Undergraduate student admission has increased steadily from 1,734 in 1987-88 to 2,045 in 1989-90. Of those admitted in the past three years, the proportion of female students was greater in the Faculties of Arts, Business Administration and Social Science. The reverse pattern, however, dominated the Faculties of Science and Medicine. Despite such faculty differences, the overall numbers of the male and female students admitted from 1987-88 to 1989-90 were very close – 1,046 males and 999 females in 1989-90. As the government has plans to expand the tertiary education sector in the coming years, annual student intake is expected to rise rather significantly in both undergraduate and postgraduate programmes.

### *Extramural Courses*

Figures show that the number of courses offered by the Department of Extramural Studies has increased from 1,697 in 1987-88 to 2,007 in 1989-90, covering a wide range of topics of interest to the general public. Each year an average of 54,000 students from different walks of life benefited from such courses.

The gradual increase in enrolment figures for language and certificate/diploma courses reflects the new demands of society in recent years. More courses in these areas have therefore been organized.

### *Degrees and Diplomas Awarded*

Each year the University confers a great variety of degrees and diplomas. Surveys on the destinations of holders of such degrees and diplomas in the past three years show that education and commerce & industry were still the two major occupational sectors that absorbed most of our graduates. Graduates from this University also served our society in other capacities such as civil servants and employees of public utilities and public and social service organizations.

### *Exchange Programmes & Hostel Places*

Exchange programmes with overseas universities have been arranged by both the University and its constituent colleges to broaden the horizons of our students and to enrich campus life. Statistics show an increase in the number of such programmes from eight in 1987-88 to 11 in 1989-90 and the number of outgoing exchange students from 25 in 1987-88 to 38 in 1989-90.

Hostel places for full-time undergraduates were still in short supply during the period. With the completion in 1989 of a new hostel for Shaw College, the University managed to provide hostel places for slightly over 50 per cent of its undergraduates in 1989-90.

Before 1987 the Postgraduate Hall Complex was able to provide accommodation to over 80 per cent of the full-time postgraduate students. With the

宿位之研究生比例逐年下降，八七至八八年降至約八成，八九至九零年更降至七成。

#### 校園建設

在這期間落成之主要建築物計有八七年十二月竣工，用以美化校本部景致之惠園；八八年杪落成，用作教職員及學生活動中心之富爾敦樓；八九年三月完工，供教學用之邵逸夫夫人樓；以及八九年七月落成之逸夫書院首期工程，為大學第四所成員書院提供各種設施。此外，尚有各項工程正在施工，或在積極籌劃之階段。報告書之有關附錄，已詳列大學在過去三年之校園建設以及未來數年之基建計劃。

#### 主要捐贈

雖然附錄內只列出此期間各項為數港幣五十萬元或以上之主要捐款，惟必須強調的是，不論金額多寡，大學對各界捐款人士及機構均深表銘感，大學已將各項捐贈臚列於八七至九零年間大學出版之《中文大學校刊》季刊內。

#### 賬 項

八七至九零年間，經由大學及理工教育資助委員會所得之政府撥款，仍然是大學經常費用之主要來源，佔大學每年收入近九成。

過去三年間，教職員著作以及大學近期之研究計劃詳情，分別收錄於本報告書之兩份附刊——《教職員著作：一九八七至九零年》及《研究項目撮要：一九八九至九零年》。附刊將於短期內出版。

校長 高 錕

一九九零年七月

continuous expansion in postgraduate programmes and enrolment figures, however, the percentage of students being so accommodated dropped from 80 in 1987-88 to 71 in 1989-90. The shortage of hostel places is expected to become more serious in future.

#### *Campus Development*

The period also saw the completion of the following major buildings: the Forum completed in December 1987 to beautify the central campus; the John Fulton Centre completed in December 1988 as an amenities centre for staff and students; the Lady Shaw Building completed in March 1989 for teaching purposes; and the Shaw College Complex completed in July 1989 to provide facilities for the University's fourth constituent college. A number of other important projects are under construction or active design. Details listed in the relevant appendix show how the University has grown 'physically' over the last three years and how it will further develop in the near future.

#### *Major Donations*

Instead of giving a comprehensive list of donations received over the period, the appendix on donations records only major contributions of HK\$500,000 and above. It must be emphasized however that the University is grateful to all benefactors irrespective of the size of their donations, and that official acknowledgement has been given to each and every donation in the *Chinese University Bulletin* published quarterly by the University between 1987 and 1990.

#### *Annual Accounts*

Government subvention through the University and Polytechnic Grants Committee continued to be the University's major source of operating revenue, making up over 88 per cent of the University's annual income from 1987 to 1990.

Details about staff publications in the three-year period and the University's recent research activities will be separately recorded in two supplements to this report, the *Staff Publications List 1987-90* and the *Research Projects Summary 1989-90*, soon to be published by the University.

Charles K. Kao  
Vice-Chancellor

July 1990





● 附 錄  
*Appendices*





## 大學管理

### *University governance*

---

大學校董會

*The Council*

大學主管人員

*University officers*

大學條例與規程修訂

*Amendments to Ordinance and  
Statutes of the University*

## 大學校董會 一九八七至九零年\*

### 主席

利國偉爵士 CBE, LLD, JP

### 副主席

胡百全博士 CBE, LLB, PhD, LLD, JP  
(至一九八八年十月十九日止)

潘永祥議員 OBE, LLB, LLM, LLD, FHKSA,  
FASA, CPA, FCIS, ATII, RAS, JP  
(自一九八八年十月二十日起)

### 校長

馬 臨博士 CBE(Hon), BSc, PhD, DSc, DLitt,  
FRSA, JP  
(至一九八七年九月三十日止)

高 錕教授 BSc, PhD, DSc, FEng, NAE(USA),  
FIEE, FIEEE, FHKIE  
(自一九八七年十月一日起)

### 副校長

徐培深教授 BSc, PhD, FInstP, FIOP, FRSA,  
JP

蔡永業教授 CBE, MD, LLD, FRCP, FRCPE,  
FFCM, DTM&H, JP  
(至一九八七年六月三十日止;一九八七年七月  
一日起再度獲委署理該職務至十二月三十一日)

金耀基教授 BA, MA, PhD  
(自一九八九年十月十一日起)

### 司庫

潘永祥議員 MBE, LLB, LLM, FHKSA, FASA,  
CPA, FCIS, ATII, RAS, JP  
(至一九八九年六月三十日止)

林李翹如女士 BA, JP  
(自一九八九年七月一日起)

### 終身校董

簡悅強爵士 GBE, BA, LLD, JP

胡百全博士 CBE, LLB, PhD, LLD, JP  
(自一九八八年十月五日起)

The Right Honourable Lord Todd of Trumpington,  
OM, MA, DPhil, DSc, LLD, DLitt, FRIC, FRS  
(自一九九零年六月一日起)

### 書院校董會選任

#### 崇基學院

孔祥勉先生 MBE, LLB, AAIA

蘇宗仁博士 BA, DipEd, MA, PhD

#### 新亞書院

陶學祁博士 BSc, MSc, DEng, CEng, FHKIE,  
FIMechE, FASME, FCIBSE, FASHRAE,  
FCI Arb, FIEAust

唐翔千先生 OBE, BA, MSc, JP

#### 聯合書院

邵逸夫爵士 CBE, LLD, DSSc, DLitt, DSc,  
DHumL

何 添博士 OBE, DSSc, JP

#### 逸夫書院

馬 臨教授 CBE(Hon), BSc, PhD, DSc, DLitt,  
LLD, DHumL, FRSA, JP

(自一九八七年九月十日起)

蔡永業教授 CBE, MD, LLD, FRCP, FRCPE,  
FFCM, DTM&H, JP

(自一九八七年九月十日起)

### 書院院長

#### 崇基學院

傅元國教授 Dip, MS, PhD

(至一九八八年七月三十一日止)

\*刊載一九八七年四月一日至一九九零年七月三十一日期內之資料

**The Council 1987-90\*****Chairman**

Sir Q. W. Lee, CBE, LL.D, JP

**Vice-Chairman**

Dr. P. C. Woo, CBE, LLB, PhD, LL.D, JP  
(until 19th October 1988)

Dr. the Honourable Peter Poon Wing-cheung, OBE,  
LLB, LL.M, LL.D, FHKSA, FASA, CPA, FCIS,  
ATII, RAS, JP  
(from 20th October 1988)

**Vice-Chancellor**

Dr. Ma Lin, CBE(Hon), BSc, PhD, DSc, DLitt,  
FRSA, JP  
(until 30th September 1987)

Prof. Charles K. Kao, BSc, PhD, DSc, FEng,  
NAE(USA), FIEE, FIEEE, FHKIE  
(from 1st October 1987)

**Pro-Vice-Chancellors**

Prof. Baysung Hsu, BSc, PhD, FInstP, FIOP, FRSA,  
JP

Prof. G. H. Choa, CBE, MD, LL.D, FRCP, FRCPE,  
FFCM, DTM&H, JP  
(until 30th June 1987; reappointed on an acting  
basis from 1st July to 31st December 1987)

Prof. Ambrose Y. C. King, BA, MA, PhD  
(from 11th October 1989)

**Treasurer**

The Honourable Peter Poon Wing-cheung, MBE,  
LLB, LL.M, FHKSA, FASA, CPA, FCIS, ATII,  
RAS, JP  
(until 30th June 1989)

Mrs. Alice Kiu-yue Lam, BA, JP  
(from 1st July 1989)

**Life members appointed by the Council**

Sir Yuet-keung Kan, GBE, BA, LL.D, JP  
Dr. P. C. Woo, CBE, LLB, PhD, LL.D, JP  
(from 5th October 1988)

The Right Honourable Lord Todd of Trumpington,  
OM, MA, DPhil, DSc, LL.D, DLitt, FRIC, FRS  
(from 1st June 1990)

**Two members elected by the board of trustees of each college from among its own members***Chung Chi College*

Mr. James Z. M. Kung, MBE, LLB, AAIA  
Dr. Su Chung-jen, BA, DipEd, MA, PhD

*New Asia College*

Dr. Edwin Tao, BSc, MSc, DEng, CEng, FHKIE,  
FIMechE, FASME, FCIBSE, FASHRAE,  
FCI Arb, FIEAust  
Mr. Hsiang-chien Tang, OBE, BA, MSc, JP

*United College*

Sir Run Run Shaw, CBE, LL.D, DSSc, DLitt, DSc,  
DHumL  
Dr. Ho Tim, OBE, DSSc, JP

*Shaw College*

Prof. Ma Lin, CBE(Hon), BSc, PhD, DSc, DLitt,  
LL.D, DHumL, FRSA, JP  
(from 10th September 1987)  
Prof. G. H. Choa, CBE, MD, LL.D, FRCP, FRCPE,  
FFCM, DTM&H, JP  
(from 10th September 1987)

**The head of each college***Chung Chi College*

Dr. Philip Fu, Dip, MS, PhD  
(until 31st July 1988)

\* Containing information as from 1st April 1987 to 31st July 1990

譚尚渭教授 BSc, MSc, PhD, CChem, FRSC, JP  
(一九八八年八月一日至一九九零年七月三十一日)

新亞書院  
林聰標教授 BA, Dip Volkswirt, PhD

聯合書院  
陳天機教授 ScB, MA, PhD, FIEEE  
(至一九八八年七月三十一日止)  
李卓予教授 BSc, MSc, PhD  
(自一九八八年八月一日起)

逸夫書院  
陳佳藉教授 MB, MSc, FRCPsych, FRANZCP, DPM

#### 學院及研究院院長

文學院  
沈宣仁博士 BA, MA, BD, PhD  
(至一九八九年七月三十一日止)  
何秀煌教授 BA, MA, PhD  
(自一九八九年八月一日起)

工商管理學院  
鍾汝滔教授 BCom, MBA, DBA, FCA  
(至一九八七年七月三十一日止)  
閔建蜀教授 MA, PhD  
(自一九八七年八月一日起)

醫學院  
李川軍教授 MB BS, PhD, MRCPPath, FRCP, FRCPA, FCAP  
(至一九八九年六月三十日止)  
胡德佑教授 MB BS, DA, FFARCS, FFARACS  
(自一九八九年七月一日起)

理學院  
麥松威教授 BSc, PhD  
(至一九八八年七月三十一日止)  
林逸華教授 BSc, MSc, PhD, CEng, FIEE, FHKIE  
(自一九八八年八月一日起)

社會科學院  
李沛良教授 BSSc, PhD  
(至一九八九年七月三十一日止)

關信基教授 LLB, MA, PhD  
(自一九八九年八月一日起)

研究院  
譚尚渭教授 BSc, MSc, PhD, CChem, FRSC, JP

#### 書院院務委員會選任

崇基學院  
陳特博士 Dip, PhD  
(至一九八九年四月二十二日止)  
傅元國教授 Dip, MS, PhD  
(自一九八九年四月二十三日起)

新亞書院  
喬健教授 BA, MA, PhD  
(至一九八九年四月二十六日止)  
麥松威教授 BSc, PhD  
(自一九八九年四月二十七日起)

聯合書院  
林逸華教授 BSc, MSc, PhD, CEng, FIEE, FHKIE  
(至一九八七年五月二十五日止)  
李卓予教授 BSc, MSc, PhD  
(自一九八七年五月二十六日起)

逸夫書院  
詹德隆先生 BA, AdvDipPol & Govt  
(自一九八七年八月一日起)

#### 教務會選任

金耀基教授 BA, MA, PhD  
林逸華教授 BSc, MSc, PhD, CEng, FIEE, FHKIE  
(至一九八九年七月三十一日止)  
李國章教授 MA, MD, BChir, FRCS, FRCSE, FRACS, FACS  
劉述先教授 BA, MA, PhD  
(自一九八九年八月一日起)

#### 校董會由海外教育機構薦任

Dr. Clark Kerr, PhD, LL.D

Prof. S. W. Tam, BSc, MSc, PhD, CChem, FRSC, JP  
(from 1st August 1988 to 31st July 1990)

*New Asia College*

Prof. Lin Tzong-biau, BA, Dip Volkswirt, PhD

*United College*

Prof. Tien-chi Chen, ScB, MA, PhD, FIEEE  
(until 31st July 1988)

Prof. Lee Cheuk-yu, BSc, MSc, PhD  
(from 1st August 1988)

*Shaw College*

Prof. Char-nie Chen, MB, MSc, FRCPsych,  
FRANZCP, DPM

**The dean of each faculty and of the Graduate School**

*Faculty of Arts*

Dr. Philip Shen, BA, MA, BD, PhD  
(until 31st July 1989)

Dr. Ho Hsiu-hwang, BA, MA, PhD  
(from 1st August 1989)

*Faculty of Business Administration*

Prof. Chung Yu-to, BCom, MBA, DBA, FCA  
(until 31st July 1987)

Prof. Mun Kin-chok, MA, PhD  
(from 1st August 1987)

*Faculty of Medicine*

Prof. Joseph C. K. Lee, MB BS, PhD, MRCPATH,  
FRCP, FRCPA, FCAP  
(until 30th June 1989)

Prof. Teik-ewe Oh, MB BS, DA, FFARCS,  
FFARACS  
(from 1st July 1989)

*Faculty of Science*

Prof. Thomas C. W. Mak, BSc, PhD  
(until 31st July 1988)

Prof. Y. W. Lam, BSc, MSc, PhD, CEng, FIEE,  
FHKIE  
(from 1st August 1988)

*Faculty of Social Science*

Prof. Rance Pui-leung Lee, BSSc, PhD  
(until 31st July 1989)

Dr. Kuan Hsin-chi, LLB, MA, PhD  
(from 1st August 1989)

*Graduate School*

Prof. S. W. Tam, BSc, MSc, PhD, CChem, FRSC, JP

**One fellow of each college elected by the college's assembly of fellows**

*Chung Chi College*

Dr. Chen Te, Dip, PhD  
(until 22nd April 1989)

Dr. Philip Fu, Dip, MS, PhD  
(from 23rd April 1989)

*New Asia College*

Dr. Chiao Chien, BA, MA, PhD  
(until 26th April 1989)

Prof. Thomas C. W. Mak, BSc, PhD  
(from 27th April 1989)

*United College*

Prof. Y. W. Lam, BSc, MSc, PhD, CEng, FIEE,  
FHKIE  
(until 25th May 1987)

Prof. Lee Cheuk-yu, BSc, MSc, PhD  
(from 26th May 1987)

*Shaw College*

Mr. T. L. Tsim, BA, AdvDipPol & Govt  
(from 1st August 1987)

**Three members elected by the Senate from among the academic members of the Senate**

Prof. Ambrose Y. C. King, BA, MA, PhD  
Prof. Y. W. Lam, BSc, MSc, PhD, CEng, FIEE,  
FHKIE  
(until 31st July 1989)

Prof. Arthur K. C. Li, MA, MD, BChir, FRCS,  
FRCSE, FRACS, FACS

Prof. Liu Shu-hsien, BA, MA, PhD  
(from 1st August 1989)

**Not more than four persons from universities or education organizations outside Hong Kong who shall be nominated by the Council**

Dr. Clark Kerr, PhD, LLD

The Right Honourable Lord Todd of Trumpington,  
OM, MA, DPhil, DSc, LL.D, DLitt, FRIC, FRS

(至一九九零年五月三十一日止)

Prof. Peter Karmel, AC, CBE, BA, PhD, LL.D,  
DLitt, DUniv, FACE, FASSA

(自一九九零年七月一日起)

#### 大學監督委任

胡百全博士 CBE, LLB, PhD, LL.D, JP

(至一九八八年十月四日止)

王廣武博士 BA, MA, PhD, FAHA

Dr. W. C. L. Brown, OBE, DSSc, JP

(至一九八七年六月三十日止)

冼為堅先生

(自一九八七年七月一日起)

田元灝議員 CBE, LL.D, DSSc, FRCSE, FCI,  
FHKIE, JP

(至一九八七年十月十七日止)

潘永祥議員 OBE, LLB, LL.M, LL.D, FHKSA,  
FASA, CPA, FCIS, ATII, RAS, JP

(自一九八八年十月一日起)

#### 立法局官守議員以外之議員互相選任

鄧蓮如勳爵 DBE, BS, LL.D, JP

陳壽霖議員 CBE, MSc, DSc, DIC, FIEE,  
SMIEEE, FHKIE, JP

(至一九八七年八月三十一日止)

譚惠珠議員 CBE, LLB, LL.D, JP

鍾沛林議員 LLB, PCLL, ACI Arb, JP

(自一九八七年十月二日起)

#### 校董會由香港居民中選任

利榮森博士 OBE, BA, LL.D

黃用諷教授 OBE, BSc, PhD, DSc, DLit,  
JP

利國偉爵士 CBE, LL.D, JP

馮秉芬爵士 CBE, LL.D, DSocSc, KStJ,  
JP

#### 秘書

梁少光先生 BSocSc, MDiv



The Right Honourable Lord Todd of Trumpington,  
OM, MA, DPhil, DSc, LL.D, DLitt, FRIC, FRS  
(until 31st May 1990)

Prof. Peter Karmel, AC, CBE, BA, PhD, LL.D,  
DLitt, DUniv, FACE, FASSA  
(from 1st July 1990)

**Four persons nominated by the Chancellor**

Dr. P. C. Woo, CBE, LLB, PhD, LL.D, JP  
(until 4th October 1988)

Dr. Wang Gungwu, BA, MA, PhD, FAHA

Dr. W. C. L. Brown, OBE, DSSc, JP  
(until 30th June 1987)

Mr. David W. K. Sin  
(from 1st July 1987)

Dr. the Honourable Francis Y. H. Tien, CBE, LL.D,  
DSSc, FRCSE, FCI, FHKIE, JP  
(until 17th October 1987)

Dr. the Honourable Peter Poon Wing-cheung, OBE,  
LLB, LL.M, LL.D, FHKSA, FASA, CPA, FCIS,  
ATII, RAS, JP  
(from 1st October 1988)

**Three persons elected by members of the  
Legislative Council, other than official members,  
from among their own number**

The Right Honourable Lady Dunn of Hong Kong  
Island and Knightsbridge, DBE, BS, LL.D, JP  
Dr. the Honourable S. L. Chen, CBE, MSc, DSc,  
DIC, FIEE, SMIEEE, FHKIE, JP  
(until 31st August 1987)

Dr. the Honourable Maria Wai-chu Tam, CBE,  
LLB, LL.D, JP

The Honourable Chung Pui-lam, LLB, PCLL,  
ACI Arb, JP  
(from 2nd October 1987)

**Not more than four other persons, normally  
resident in Hong Kong, who shall be elected by  
the Council**

Dr. J. S. Lee, OBE, BA, LL.D

Prof. Y. C. Wong, OBE, BSc, PhD, DSc, DLit, JP

Sir Q. W. Lee, CBE, LL.D, JP

Sir Kenneth Ping-fan Fung, CBE, LL.D, DSocSc,  
KSJ, JP

**Secretary of the Council**

Mr. Jacob Leung, BSocSc, MDiv

## 大學主管人員 一九八七至九零年\*

### 監督

衛奕信爵士 KCMG, PhD, LLD

### 副監督

簡悅強爵士 GBE, BA, LLD, JP

### 校長

馬 臨博士 CBE(Hon), BSc, PhD, DSc, DLitt,  
FRSA, JP

(至一九八七年九月三十日止)

高 錕教授 BSc, PhD, DSc, FEng, NAE(USA),  
FIEE, FIEEE, FHKIE

(自一九八七年十月一日起)

### 副校長

徐培深教授 BSc, PhD, FInstP, FIOP, FRSA,  
JP

蔡永業教授 CBE, MD, LLD, FRCP, FRCPE,  
FFCM, DTM&H, JP

(至一九八七年六月三十日止;一九八七年七月  
一日起再度獲委署理該職務至十二月三十一日)

金耀基教授 BA, MA, PhD

(自一九八九年十月十一日起)

### 司庫

潘永祥議員 MBE, LLB, LLM, FHKSA, FASA,  
CPA, FCIS, ATII, RAS, JP

(至一九八九年六月三十日止)

林李翹如女士 BA, JP

(自一九八九年七月一日起)

### 崇基學院院長

傅元國教授 Dip, MS, PhD

(至一九八八年七月三十一日止)

譚尚渭教授 BSc, MSc, PhD, CChem, FRSC,  
JP

(一九八八年八月一日至一九九零年七月  
三十一日)

### 新亞書院院長

林聰標教授 BA, Dip Volkswirt, PhD

### 聯合書院院長

陳天機教授 ScB, MA, PhD, FIEEE

(至一九八八年七月三十一日止)

李卓予教授 BSc, MSc, PhD

(自一九八八年八月一日起)

### 逸夫書院院長

陳佳蘊教授 MB, MSc, FRCPsych,  
FRANZCP, DPM

### 研究院院長

譚尚渭教授 BSc, MSc, PhD, CChem, FRSC,  
JP

### 文學院院長

沈宣仁博士 BA, MA, BD, PhD

(至一九八九年七月三十一日止)

何秀煌教授 BA, MA, PhD

(自一九八九年八月一日起)

### 工商管理學院院長

鍾汝滔教授 BCom, MBA, DBA, FCA

(至一九八七年七月三十一日止)

閔建蜀教授 MA, PhD

(自一九八七年八月一日起)

### 醫學院院長

李川軍教授 MB BS, PhD, MRCPATH,  
FRCP, FRCPA, FCAP

(至一九八九年六月三十日止)

\*刊載一九八七年四月一日至一九九零年七月三十一日期內之資料

## University Officers 1987- 90\*

### Chancellor

His Excellency Sir David Wilson, KCMG, PhD,  
LLD

Prof. S. W. Tam, BSc, MSc, PhD, CChem, FRSC,  
JP  
(from 1st August 1988 to 31st July 1990)

### Pro-Chancellor

Sir Yuet-keung Kan, GBE, BA, LLD, JP

### Head of New Asia College

Prof. Lin Tzong-biau, BA, Dip Volkswirt, PhD

### Vice-Chancellor

Dr. Ma Lin, CBE (Hon), BSc, PhD, DSc, DLitt,  
FRSA, JP  
(until 30th September 1987)

### Head of United College

Prof. Tien-chi Chen, ScB, MA, PhD, FIEEE  
(until 31st July 1988)  
Prof. Lee Cheuk-yu, BSc, MSc, PhD  
(from 1st August 1988)

Prof. Charles K. Kao, BSc, PhD, DSc, FEng,  
NAE (USA), FIEE, FIEEE, FHKIE  
(from 1st October 1987)

### Head of Shaw College

Prof. Char-nie Chen, MB, MSc, FRCPsych,  
FRANZCP, DPM

### Pro-Vice-Chancellors

Prof. Baysung Hsu, BSc, PhD, FInstP, FIOP, FRSA,  
JP

### Dean of the Graduate School

Prof. S. W. Tam, BSc, MSc, PhD, CChem, FRSC,  
JP

Prof. G.H. Choa, CBE, MD, LLD, FRCP, FRCPE,  
FFCM, DTM&H, JP  
(until 30th June 1987; reappointed on an acting  
basis from 1st July to 31st December 1987)

Prof. Ambrose Y. C. King, BA, MA, PhD  
(from 11th October 1989)

### Dean of Arts

Dr. Philip Shen, BA, MA, BD, PhD  
(until 31st July 1989)  
Dr. Ho Hsiu-hwang, BA, MA, PhD  
(from 1st August 1989)

### Treasurer

The Honourable Peter Poon Wing-cheung, MBE,  
LLB, LLM, FHKSA, FASA, CPA, FCIS, ATII,  
RAS, JP  
(until 30th June 1989)

Mrs. Alice Kiu-yue Lam, BA, JP  
(from 1st July 1989)

### Dean of Business Administration

Prof. Chung Yu-to, BCom, MBA, DBA, FCA  
(until 31st July 1987)  
Prof. Mun Kin-chok, MA, PhD  
(from 1st August 1987)

### Head of Chung Chi College

Dr. Philip Fu, Dip, MS, PhD  
(until 31st July 1988)

### Dean of Medicine

Prof. Joseph C. K. Lee, MB BS, PhD, MRCPATH,  
FRCP, FRCPA, FCAP  
(until 30th June 1989)

\* Containing information as from 1st April 1987 to 31st July 1990

胡德佑教授 MB BS, DA, FFARCS,  
FFARACS  
(自一九八九年七月一日起)

**理學院院長**

麥松威教授 BSc, PhD  
(至一九八八年七月三十一日止)  
林逸華教授 BSc, MSc, PhD, CEng, FIEE,  
FHKIE  
(自一九八八年八月一日起)

**社會科學院院長**

李沛良教授 BSSc, PhD  
(至一九八九年七月三十一日止)  
關信基教授 LLB, MA, PhD  
(自一九八九年八月一日起)

**秘書長**

梁少光先生 BSocSc, MDiv

**教務長**

楊汝萬教授 BA, DipEd, MA, PhD  
(至一九九零年三月十八日止)  
吳利明教授 BA, BD, ThM, ThD  
(自一九九零年三月十九日起)

**圖書館館長**

顏達威博士 AB, MDiv, MSLS, MA, PhD,  
LLB  
(至一九八九年十月二十日止)

**總務長**

Mr. David A. Gilkes, MA, FCA, FHKSA, JP

Prof. Teik-ewe Oh, MB BS, DA, FFARCS,  
FFARACS  
(from 1st July 1989)

**Dean of Science**

Prof. Thomas C. W. Mak, BSc, PhD  
(until 31st July 1988)

Prof. Y. W. Lam, BSc, MSc, PhD, CEng, FIEE,  
FHKIE  
(from 1st August 1988)

**Dean of Social Science**

Prof. Rance Pui-leung Lee, BSSc, PhD  
(until 31st July 1989)

Prof. Kuan Hsin-chi, LLB, MA, PhD  
(from 1st August 1989)

**Secretary**

Mr. Jacob Leung, BSocSc, MDiv

**Registrar**

Prof. Yeung Yue-man, BA, DipEd, MA, PhD  
(until 18th March 1990)

Dr. Ng Lee-Ming, BA, BD, ThM, ThD  
(from 19th March 1990)

**Librarian**

Dr. David S. Yen, AB, MDiv, MSLS, MA, PhD,  
LLB  
(until 20th October 1989)

**Bursar**

Mr. David A. Gilkes, MA, FCA, FHKSA, JP

**一九八七年八月一日至一九九零年七月三十一日期間，大學條例與規程（香港法例第一一零九章）之修訂**

| 監督通過<br>修訂條例之日期 | 摘 要  |
|-----------------|--|
| 一九八八年<br>一月十六日  | 修訂規程第十一條，讓現任校董再度獲任命或推選之續任期可少於三年。   |
| 一九八八年<br>八月二十三日 | 修訂規程第三、第十及第十四條之下列內容：<br>(i) 指定大學輔導長為大學成員；<br>(ii) 聘任大學輔導長及訂定其職責，包括出任教務會委員；<br>(iii) 接納學生代表加入教務會，惟學生委員不得參與視為限制範圍內之事項；及<br>(iv) 相應修訂教務會會議之法定人數及會議中決定其他有關事項之委員人數。 |
| 一九八九年<br>三月三十日  | 修訂規程第二十六條之下列內容：<br>(i) 可頒授之學位增設教育學學位；及<br>(ii) 取消原來以學院為基礎之學位分類法。   |
| 一九九零年<br>一月十六日  | 修訂規程第二十六條，可頒授之學位增設醫學科學學士學位。  |
| 一九九零年<br>五月六日   | 修訂規程第十四條，教務會學生委員之名額由四名增至五名。  |

**Amendments to Ordinance and Statutes of the University (CAP 1109) from 1st August 1987 to 31st July 1990**

| <b>Date of Approval Given by Chancellor</b> | <b>Particulars</b>  |
|---|---|
| 16th January 1988                           | Statute 11 was amended to provide for the re-election or re-nomination of Council members for a period of less than three years.  |
| 23rd August 1988                            | Statutes 3, 10 and 14 were amended to provide for the following:<br>(i) designation of the Director of Student Affairs as a member of the University;<br>(ii) appointment of and assignment of duties, including Senate membership, to the Director of Student Affairs;<br>(iii) admission of student representatives to Senate membership with specific provisions on their participation in reserved areas of business; and<br>(iv) consequential amendments to the number of Senate members required for a quorum and other matters relating to Senate meetings. |
| 30th March 1989                             | Statute 26 was amended for the purpose of<br>(i) providing for the conferment of new degrees in Education; and<br>(ii) doing away with the previous classification of degrees by reference to the Faculties.  |
| 16th January 1990                           | Statute 26 was amended for the purpose of providing for the new Bachelor of Medical Sciences (B.Med.Sc.) degree.  |
| 6th May 1990                                | Statute 14 was amended for the purpose of adding a fifth student member to the Senate.  |







**教職員資料**  
*Staff information*

---

**全職教職員人數 一九八七至九零年**  
**Number of Full-time Staff 1987 – 90**

| 教職員 Staff                                | 1987-88 | 1988-89 | 1989-90 |
|--|---------|---------|---------|
| <b>教 學 Academic</b>                      |         |         |         |
| 講座教授 Professor                           | 38      | 41      | 42      |
| 教 授 Reader                               | 22      | 23      | 28      |
| 高級講師 Senior Lecturer                     | 135     | 132     | 139     |
| 講 師 Lecturer                             | 339     | 342     | 366     |
| 副講師 Assistant Lecturer                   | 21      | 20      | 21      |
| 高級導師及導師 Senior Instructor and Instructor | 55      | 66      | 67      |
|  | 610     | 624     | 663     |
| 研 究 Research                             | 69      | 66      | 71      |
| 行 政 Administrative                       | 139     | 148     | 152     |
| 專 業 Professional                         | 92      | 98      | 100     |
| 技 術 Technical                            | 325     | 333     | 352     |
| 文 書 Office Supporting                    | 532     | 567     | 587     |
| 職 工 Minor                                | 739     | 740     | 794     |
| 總人數 Total                                | 2,506   | 2,576   | 2,719   |

**全職教職員分布**  
**Distribution of Full-time Staff**

1987-88

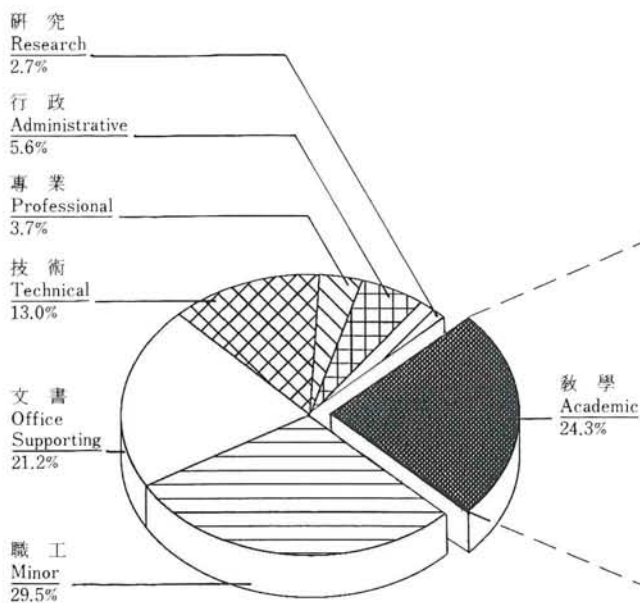

**全職教師分布**  
**Distribution of Full-time Academic Staff**

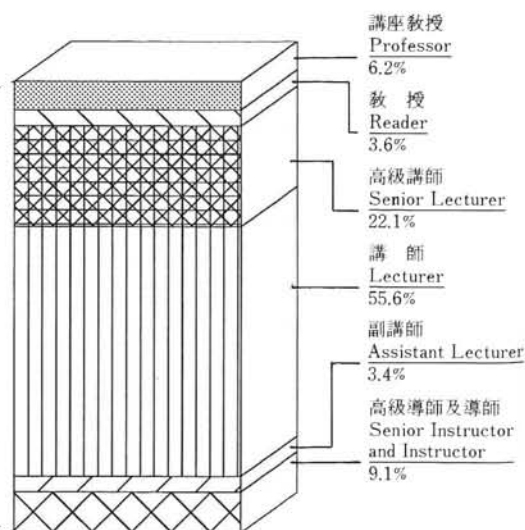

### 全職教職員分布 Distribution of Full-time Staff

1988-89

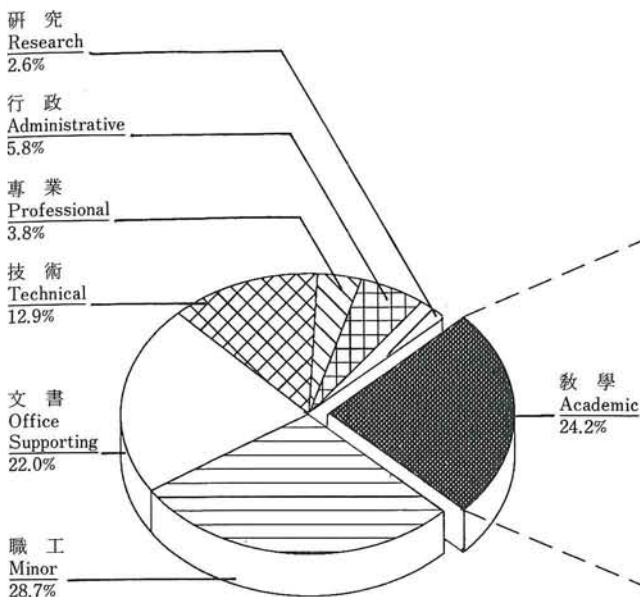

### 全職教師分布 Distribution of Full-time Academic Staff

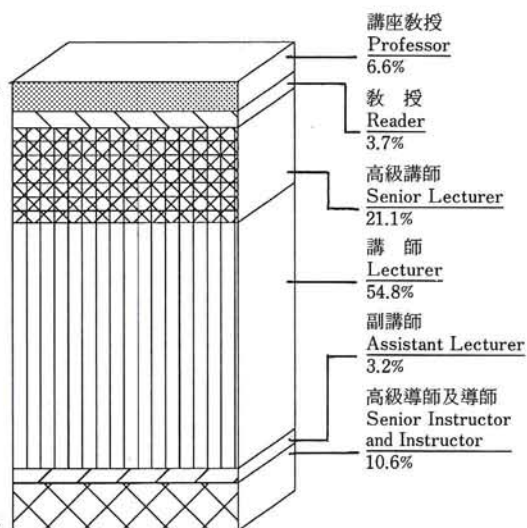

1989-90

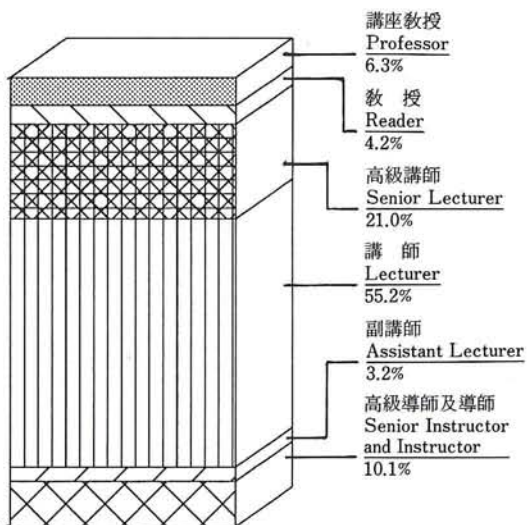
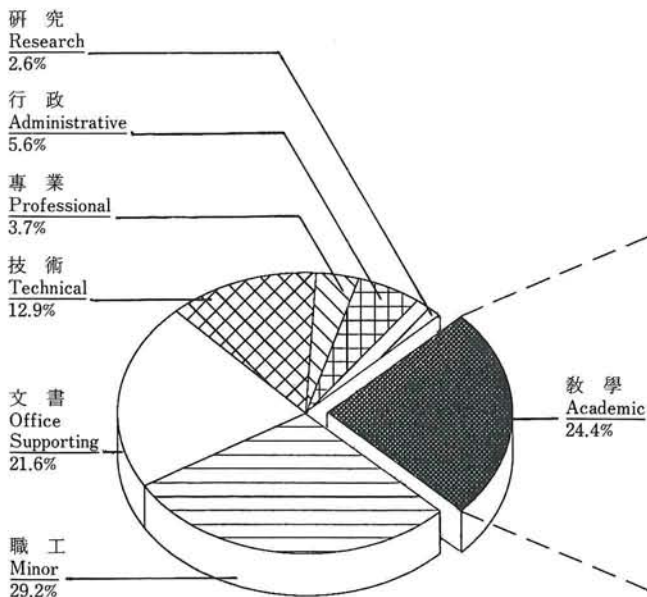

註：當年十二月三十一日計算

包括私人基金資助之全職教師及訪問學人，惟兼任及擔任名譽職務者除外

Notes: All figures as at 31st December

Full-time staff supported by private funds and visiting academics are included but staff on honorary appointments are excluded





## 學生資料

### *Student information*

---

學生人數

*Enrolment figures*

入學人數

*Admission figures*

修讀校外課程學生人數

*Number of students taking extramural courses*

學位及文憑頒授數目

*Number of degrees and diplomas awarded*

學位及文憑畢業生去向

*Destinations of degree and diploma holders*

交換計劃

*Exchange programmes*

宿位

*Hostel places*

## 本科生人數 一九八七至九零年

## Undergraduate Student Enrolment 1987-90

| 學院<br>Faculty/School               | 1987-88        |                |                | 1988-89        |                |                | 1989-90        |                |                |
|------------------------------------|----------------|----------------|----------------|----------------|----------------|----------------|----------------|----------------|----------------|
|                                    | 男<br>M         | 女<br>W         | 合計<br>Total    | 男<br>M         | 女<br>W         | 合計<br>Total    | 男<br>M         | 女<br>W         | 合計<br>Total    |
| 文<br>Arts                          | 292<br>(84)    | 797<br>(147)   | 1,089<br>(231) | 251<br>(84)    | 845<br>(157)   | 1,096<br>(241) | 237<br>(88)    | 852<br>(160)   | 1,089<br>(248) |
|                                    | <u>376</u>     | <u>944</u>     | <u>1,320</u>   | <u>335</u>     | <u>1,002</u>   | <u>1,337</u>   | <u>325</u>     | <u>1,012</u>   | <u>1,337</u>   |
| 工商管理<br>Business<br>Administration | 449<br>(148)   | 566<br>(52)    | 1,015<br>(200) | 415<br>(147)   | 675<br>(59)    | 1,090<br>(206) | 434<br>(149)   | 743<br>(60)    | 1,177<br>(209) |
|                                    | <u>597</u>     | <u>618</u>     | <u>1,215</u>   | <u>562</u>     | <u>734</u>     | <u>1,296</u>   | <u>583</u>     | <u>803</u>     | <u>1,386</u>   |
| 醫<br>Medicine                      | 394            | 131            | 525            | 428            | 154            | 582            | 422            | 174            | 596            |
| 理<br>Science                       | 1,225<br>—     | 361<br>—       | 1,586<br>—     | 1,268<br>—     | 404<br>—       | 1,672<br>—     | 1,446<br>(33)  | 435<br>(7)     | 1,881<br>(40)  |
|                                    | <u>1,225</u>   | <u>361</u>     | <u>1,586</u>   | <u>1,268</u>   | <u>404</u>     | <u>1,672</u>   | <u>1,479</u>   | <u>442</u>     | <u>1,921</u>   |
| 社會科學<br>Social Science             | 519<br>(90)    | 863<br>(73)    | 1,382<br>(163) | 442<br>(93)    | 936<br>(90)    | 1,378<br>(183) | 465<br>(61)    | 981<br>(75)    | 1,446<br>(136) |
|                                    | <u>609</u>     | <u>936</u>     | <u>1,545</u>   | <u>535</u>     | <u>1,026</u>   | <u>1,561</u>   | <u>526</u>     | <u>1,056</u>   | <u>1,582</u>   |
| 教育<br>Education                    | —              | —              | —              | (28)           | (8)            | (36)           | (75)           | (28)           | (103)          |
| 合計<br>Total                        | 2,879<br>(322) | 2,718<br>(272) | 5,597<br>(594) | 2,804<br>(352) | 3,014<br>(314) | 5,818<br>(666) | 3,004<br>(406) | 3,185<br>(330) | 6,189<br>(736) |
|                                    | <u>3,201</u>   | <u>2,990</u>   | <u>6,191</u>   | <u>3,156</u>   | <u>3,328</u>   | <u>6,484</u>   | <u>3,410</u>   | <u>3,515</u>   | <u>6,925</u>   |

註：當年十二月三十一日計算

( ) 內為兼讀學士學位課程學生人數

Notes: All figures as at 31st December

M = Men

W = Women

( ) indicates the number of students under Part-time Degree Programmes

研究生人數 一九八七至九零年  
Postgraduate Student Enrolment 1987 - 90

| 課程<br>Programme                  | 1987-88      |              |              | 1988-89      |              |              | 1989-90      |              |              |
|----------------------------------|--------------|--------------|--------------|--------------|--------------|--------------|--------------|--------------|--------------|
|                                  | 男<br>M       | 女<br>W       | 合計<br>Total  | 男<br>M       | 女<br>W       | 合計<br>Total  | 男<br>M       | 女<br>W       | 合計<br>Total  |
| 博士學位課程<br>Doctoral<br>Programme  | 21<br>(22)   | 7<br>(6)     | 28<br>(28)   | 12<br>(22)   | 8<br>(4)     | 20<br>(26)   | 19<br>(32)   | 10<br>(3)    | 29<br>(35)   |
|                                  | 43           | 13           | 56           | 34           | 12           | 46           | 51           | 13           | 64           |
| 碩士學位課程<br>Master's<br>Programme  | 220<br>(209) | 79<br>(81)   | 299<br>(290) | 237<br>(224) | 88<br>(81)   | 325<br>(305) | 243<br>(229) | 89<br>(87)   | 332<br>(316) |
|                                  | 429          | 160          | 589          | 461          | 169          | 630          | 472          | 176          | 648          |
| 文憑課程<br>Diploma<br>Programme     | 43<br>(334)  | 62<br>(280)  | 105<br>(614) | 41<br>(325)  | 71<br>(303)  | 112<br>(628) | 53<br>(304)  | 82<br>(293)  | 135<br>(597) |
|                                  | 377          | 342          | 719          | 366          | 374          | 740          | 357          | 375          | 732          |
| 證書課程<br>Certificate<br>Programme | (3)          | (6)          | (9)          | -            | -            | -            | -            | -            | -            |
| 合計<br>Total                      | 284<br>(568) | 148<br>(373) | 432<br>(941) | 290<br>(571) | 167<br>(388) | 457<br>(959) | 315<br>(565) | 181<br>(383) | 496<br>(948) |
|                                  | 852          | 521          | 1,373        | 861          | 555          | 1,416        | 880          | 564          | 1,444        |

註：當年十二月三十一日計算

( ) 內為兼讀學生人數

Notes: All figures as at 31st December

M = Men

W = Women

( ) indicates the number of part-time students

本科生入學人數\* 一九八七至九零年  
Undergraduate Student Admission\* 1987-90

| 學院<br>Faculty/School                    | 1987-88     |             |                | 1988-89     |             |                | 1989-90      |             |                |
|---|-------------|-------------|----------------|-------------|-------------|----------------|--------------|-------------|----------------|
|   | 男<br>M      | 女<br>W      | 合計<br>Total    | 男<br>M      | 女<br>W      | 合計<br>Total    | 男<br>M       | 女<br>W      | 合計<br>Total    |
| 文<br>Arts                               | 63<br>(13)  | 228<br>(40) | 291<br>(53)    | 66<br>(20)  | 225<br>(33) | 291<br>(53)    | 61<br>(19)   | 243<br>(39) | 304<br>(58)    |
|   | 76          | 268         | 344            | 86          | 258         | 344            | 80           | 282         | 362            |
| 工商管理<br>Business<br>Administration      | 109<br>(37) | 183<br>(15) | 292<br>(52)    | 98<br>(37)  | 193<br>(20) | 291<br>(57)    | 126<br>(34)  | 193<br>(26) | 319<br>(60)    |
|   | 146         | 198         | 344            | 135         | 213         | 348            | 160          | 219         | 379            |
| 醫 <sup>+</sup><br>Medicine <sup>+</sup> | 94          | 45          | 139            | 92          | 37          | 129            | 90           | 40          | 130            |
| 理<br>Science                            | 381<br>—    | 141<br>—    | 522<br>—       | 458<br>—    | 140<br>—    | 598<br>—       | 529<br>(37)  | 163<br>(8)  | 692<br>(45)    |
|   | 381         | 141         | 522            | 458         | 140         | 598            | 566          | 171         | 737            |
| 社會科學<br>Social Science                  | 119<br>(19) | 229<br>(18) | 348<br>(37)    | 97<br>(11)  | 249<br>(23) | 346<br>(34)    | 100<br>—     | 265<br>—    | 365<br>—       |
|   | 138         | 247         | 385            | 108         | 272         | 380            | 100          | 265         | 365            |
| 教育<br>Education                         | —           | —           | —              | (28)        | (8)         | (36)           | (50)         | (22)        | (72)           |
| 合計<br>Total                             | 766<br>(69) | 826<br>(73) | 1,592<br>(142) | 811<br>(96) | 844<br>(84) | 1,655<br>(180) | 906<br>(140) | 904<br>(95) | 1,810<br>(235) |
|   | 835         | 899         | 1,734          | 907         | 928         | 1,835          | 1,046        | 999         | 2,045          |

註：當年九月三十日計算

\*包括少數重讀生及兼讀學士學位課程之高年級新生

( ) 內為兼讀學士學位課程學生人數

<sup>+</sup>包括升自「暫編主修醫科一年級課程」之學生

Notes: All figures as at 30th September

\* Including a small number of first year repeaters and upper year entrants for the Part-time Degree Programmes

M = Men

W = Women

( ) indicates the number of students under Part-time Degree Programmes

<sup>+</sup> Including students promoted from Potential Medical Major



## 研究生入學人數 一九八七至九零年

## Postgraduate Student Admission 1987 - 90

| 課程<br>Programme                 | 1987-88      |              |              | 1988-89      |              |              | 1989-90      |              |              |
|---------------------------------|--------------|--------------|--------------|--------------|--------------|--------------|--------------|--------------|--------------|
|                                 | 男<br>M       | 女<br>W       | 合計<br>Total  | 男<br>M       | 女<br>W       | 合計<br>Total  | 男<br>M       | 女<br>W       | 合計<br>Total  |
| 博士學位課程<br>Doctoral<br>Programme | 6<br>(7)     | 3<br>(3)     | 9<br>(10)    | 10<br>(7)    | 3<br>-       | 13<br>(7)    | 17<br>(9)    | 2<br>(1)     | 19<br>(10)   |
|                                 | <u>13</u>    | <u>6</u>     | <u>19</u>    | <u>17</u>    | <u>3</u>     | <u>20</u>    | <u>26</u>    | <u>3</u>     | <u>29</u>    |
| 碩士學位課程<br>Master's<br>Programme | 115<br>(73)  | 46<br>(33)   | 161<br>(106) | 162<br>(90)  | 60<br>(36)   | 222<br>(126) | 143<br>(89)  | 57<br>(46)   | 200<br>(135) |
|                                 | <u>188</u>   | <u>79</u>    | <u>267</u>   | <u>252</u>   | <u>96</u>    | <u>348</u>   | <u>232</u>   | <u>103</u>   | <u>335</u>   |
| 文憑課程<br>Diploma<br>Programme    | 49<br>(202)  | 66<br>(162)  | 115<br>(364) | 49<br>(153)  | 72<br>(154)  | 121<br>(307) | 59<br>(186)  | 79<br>(201)  | 138<br>(387) |
|                                 | <u>251</u>   | <u>228</u>   | <u>479</u>   | <u>202</u>   | <u>226</u>   | <u>428</u>   | <u>245</u>   | <u>280</u>   | <u>525</u>   |
| 合計<br>Total                     | 170<br>(282) | 115<br>(198) | 285<br>(480) | 221<br>(250) | 135<br>(190) | 356<br>(440) | 219<br>(284) | 138<br>(248) | 357<br>(532) |
|                                 | <u>452</u>   | <u>313</u>   | <u>765</u>   | <u>471</u>   | <u>325</u>   | <u>796</u>   | <u>503</u>   | <u>386</u>   | <u>889</u>   |

註：當年九月三十日計算

( ) 內為兼讀學生人數











































Notes: All figures as at 30th September

M = Men

W = Women

( ) indicates the number of part-time students

**校外課程 一九八七至九零年**  
**Extramural Studies 1987 - 90**

| 課程數目<br>Number of courses   |   |   | 學生人數<br>Number of students   |   |   |
|---|---|---|--|---|---|
|  1987-88 |  1988-89 |  1989-90 |  1987-88  |  1988-89 |  1989-90 |
| 總數<br>Total   | 總數<br>Total   | 總數<br>Total   | 總人數<br>Total   | 總人數<br>Total  | 總人數<br>Total  |
| 1,697   | 1,713   | 2,007   | 56,210   | 53,303  | 53,758  |
| 248   |          |   |  6,101   |   |   |
| 260   |          |   |  5,939   |   |   |
| 257   |          |   |  5,882   |   |   |
|   | 86  |          |  1,907   |   |   |
|   | 58  |          |  1,550    |   |   |
|   | 56  |         |  1,459   |   |   |
|   | 79  |        |  2,713 |   |   |
|   | 71  |        |  2,773 |   |   |
|   | 70  |        |  2,420 |   |   |
| 200   |        |   |  6,421 |   |   |
| 193   |        |   |  5,960 |   |   |
| 175   |        |   |  5,393 |   |   |
|   | 32  |        |  1,051  |   |   |
|   | 25  |        |  726    |   |   |
|   | 19  |        |  460    |   |   |
| 223   |        |   |  6,658 |   |   |
| 221   |        |   |  7,376 |   |   |
| 237   |        |   |  8,040 |   |   |

|     |  |  |  |        |
|-----|--|--|--|--------|
| 120 |  | 家庭康樂課程   |  | 2,290  |
| 129 |  | Home Care & Craft  |  | 2,427  |
| 134 |  |  |  | 2,573  |
| 19  |  | 大眾傳播   |  | 275    |
| 16  |  | Mass Communication   |  | 355    |
| 19  |  |  |  | 517    |
| 136 |  | 音樂、舞蹈、戲劇   |  | 2,210  |
| 117 |  | Music, Dance & Drama   |  | 1,873  |
| 112 |  |  |  | 1,839  |
| 76  |  | 數理、健康教育及科技   |  | 1,876  |
| 78  |  | Science, Mathematics,<br>Health Education &<br>Technology                |  | 2,477  |
| 227 |  |  |  | 5,489  |
| 182 |  | 社會科學*  |  | 2,741  |
| 228 |  | Social Sciences*   |  | 2,182  |
| 226 |  |  |  | 1,994  |
| 170 |  | 學位、文憑、證書課程   |  | 1,298  |
| 189 |  | Constituent Courses<br>under Degree, Diploma &<br>Certificate Programmes |  | 1,815  |
| 319 |  |  |  | 2,754  |
| 126 |  | 遙距教育   |  | 20,669 |
| 128 |  | Distance Education   |  | 17,850 |
| 156 |  |  |  | 14,938 |

\* 社會科學包括歷史、地理、心理學、宗教、哲學、公民及公共事務，以及社會工作

\*Social Sciences include History, Geography, Psychology, Religion, Philosophy, Citizenship and Public Affairs, and Social Work

**學士學位頒授數目 一九八七至九零年**  
**Number of First Degrees Awarded 1987 - 90**

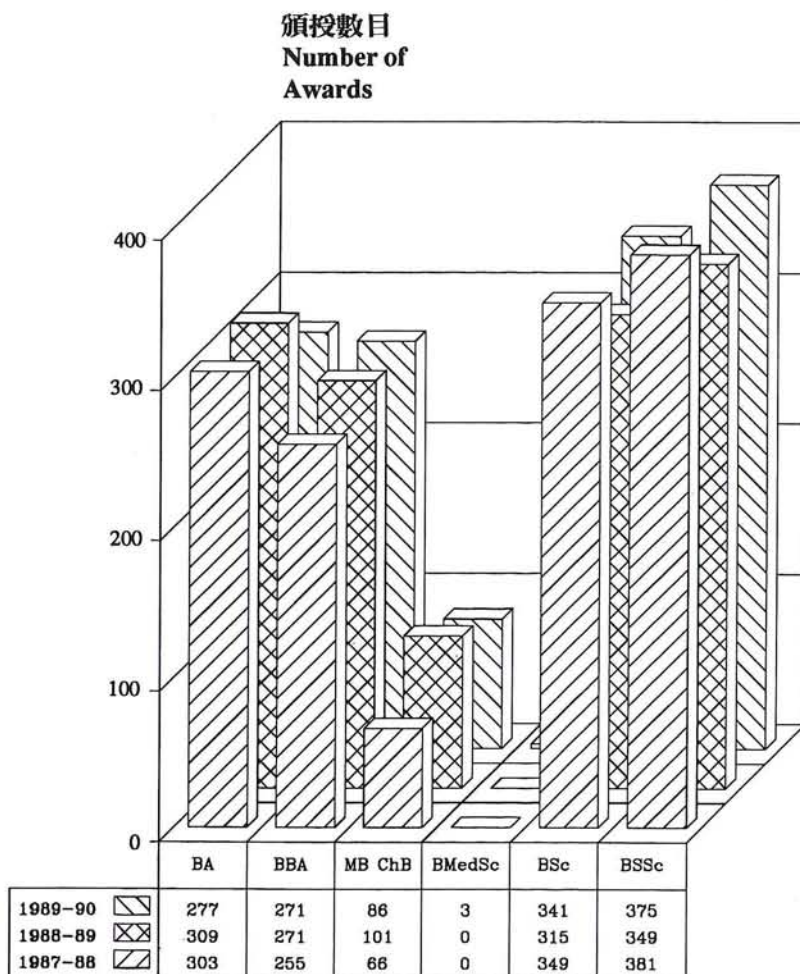

**學士學位 First Degrees**

註：所列年度為學生完成課程後考獲學位之年度

- BA- 文學士
- BBA- 工商管理學士
- MB ChB- 內外全科醫學士
- BMedSc- 醫學科學學士
- BSc- 理學士
- BSSc- 社會科學學士

Notes: Degrees listed were awarded to students who qualified for them in that academic year

- BA – Bachelor of Arts
- BBA – Bachelor of Business Administration
- MB ChB – Bachelor of Medicine and Bachelor of Surgery
- BMedSc – Bachelor of Medical Sciences
- BSc – Bachelor of Science
- BSSc – Bachelor of Social Science

### 高級學位及文憑頒授數目 一九八七至九零年 Number of Postgraduate Degrees and Diplomas Awarded 1987 – 90

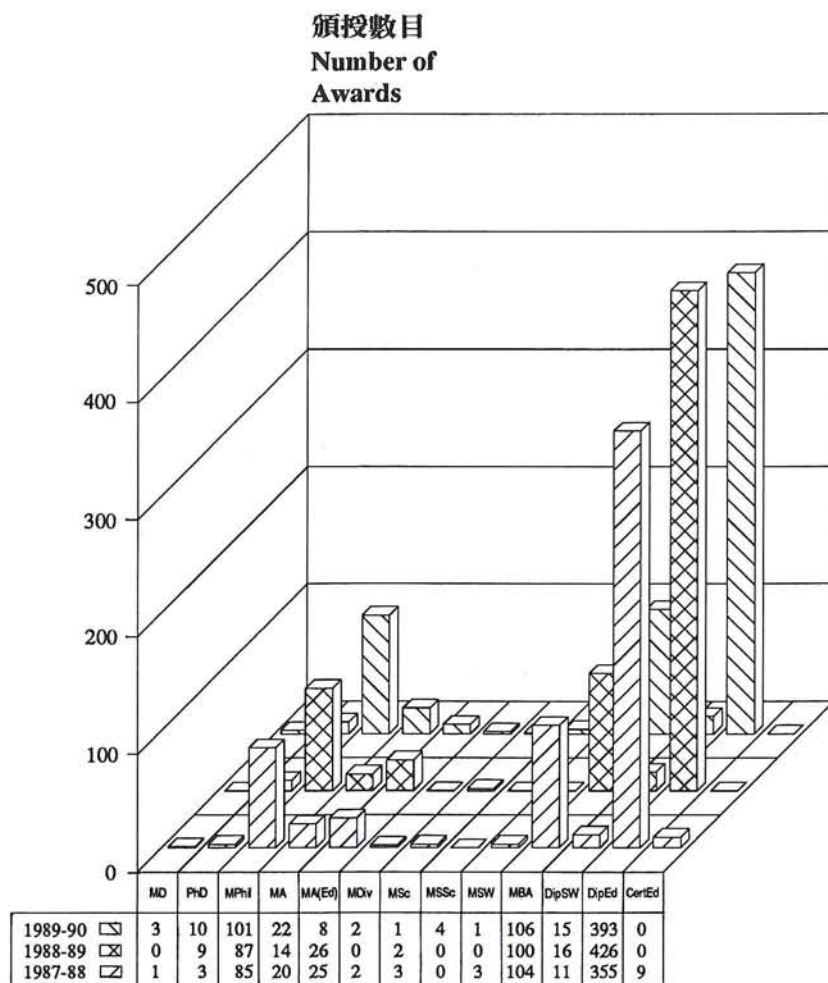

高級學位及文憑 Postgraduate Degrees and Diplomas

註：MD-醫學博士  
 PhD-哲學博士  
 MPhil-哲學碩士  
 MA-文學碩士  
 MA(Ed)-文學碩士(教育學)  
 MDiv-神學碩士  
 MSc-理學碩士  
 MSSc-社會科學碩士  
 MSW-社會工作學碩士  
 MBA-工商管理學碩士  
 DipSW-社會工作文憑  
 DipEd-教育文憑  
 CertEd-教師教育證書

Notes: MD – Doctor of Medicine  
 PhD – Doctor of Philosophy  
 MPhil – Master of Philosophy  
 MA – Master of Arts  
 MA(Ed) – Master of Arts in Education  
 MDiv – Master of Divinity  
 MSc – Master of Science  
 MSSc – Master of Social Science  
 MSW – Master of Social Work  
 MBA – Master of Business Administration  
 DipSW – Diploma in Social Work  
 DipEd – Diploma in Education  
 CertEd – Certificate in Teacher Education

學士學位畢業生去向 一九八七至八九年  
Destinations of First Degree Holders 1987 - 89

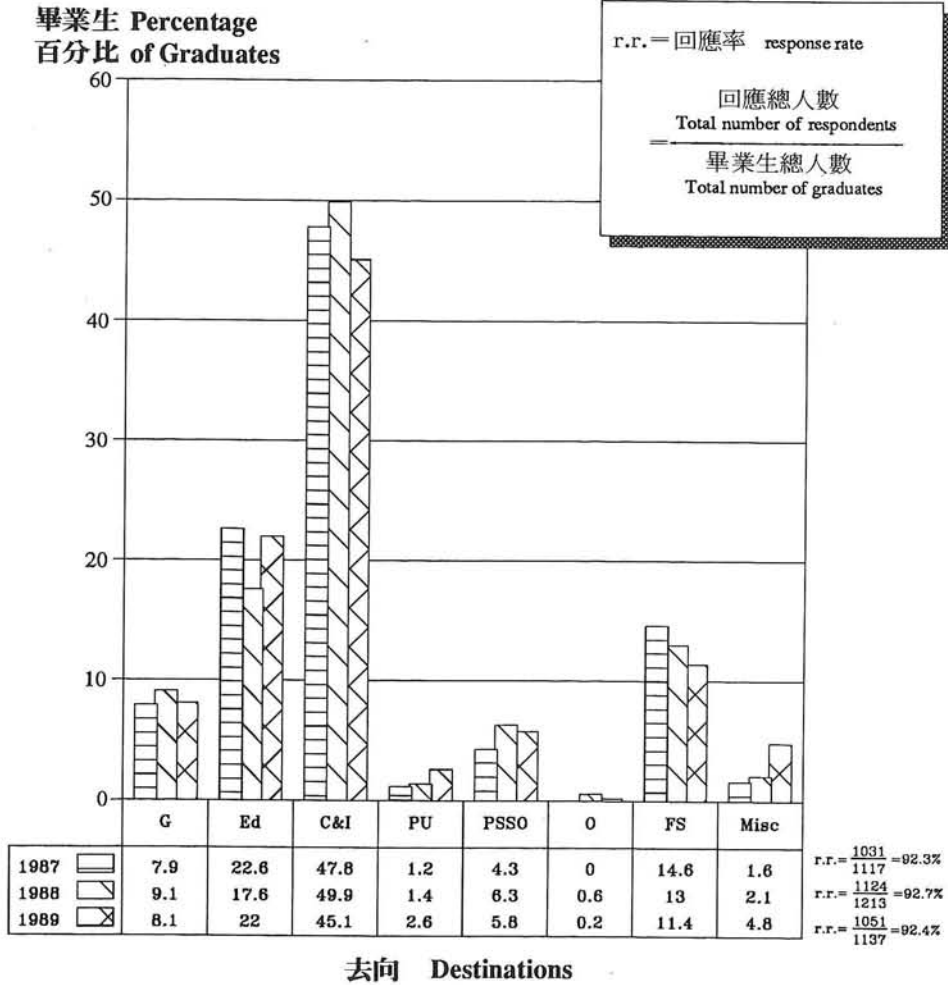

去向 Destinations

註：不包括醫學院及兼讀學士學位課程之學生

G- 政府 (任職助理教育主任者列入「教育」類別)

Ed- 教育

C & I- 工商業

PU- 公用事業

PSSO- 公共及社會服務機構

O- 其他行業 (宗教及非牟利機構)

FS- 進修

Misc- 雜類 (於調查期間移民、在海外工作、療養、旅遊、準備升學、因私人理由而未求職、逝世、或仍在找尋合適工作)

Notes: Medical students and students under Part-time Degree Programmes are not included

G - Government (not including Assistant Education Officers who are grouped under the Education sector)

Ed - Education

C & I - Commerce and Industry

PU - Public Utilities

PSSO - Public and Social Service Organizations

O - Other Employment (religious and other non-profit making associations)

FS - Further Studies

Misc - Miscellaneous (emigrated abroad, working overseas, recovering from illness, travelling, preparing for further studies, not seeking employment owing to personal reasons, deceased, or still seeking suitable employment at the time of the survey)

**文學院學士學位畢業生去向**  
**Destinations of first degree holders, Arts Faculty**

**1987**

r.r. =  $\frac{232}{259} = 89.6\%$

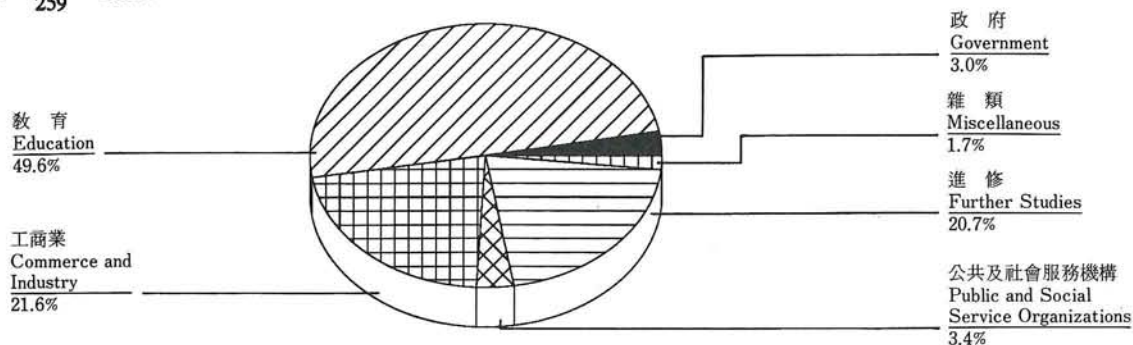

**1988**

r.r. =  $\frac{254}{263} = 96.6\%$

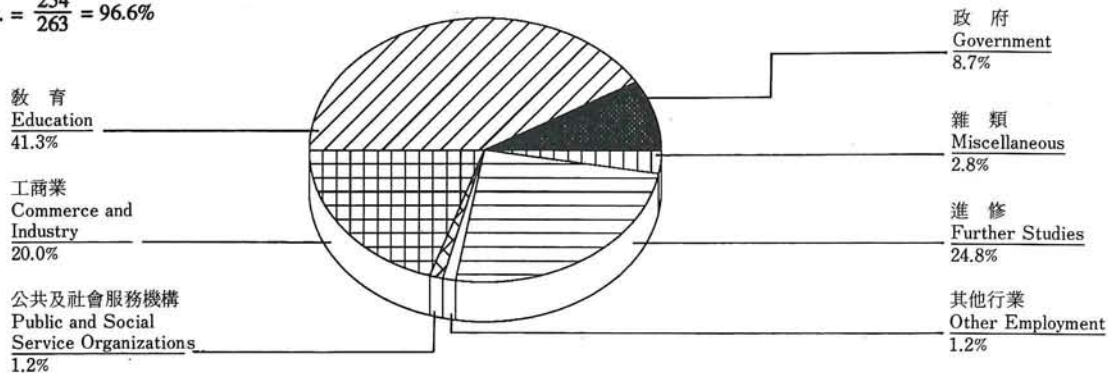

**1989**

r.r. =  $\frac{251}{273} = 91.9\%$

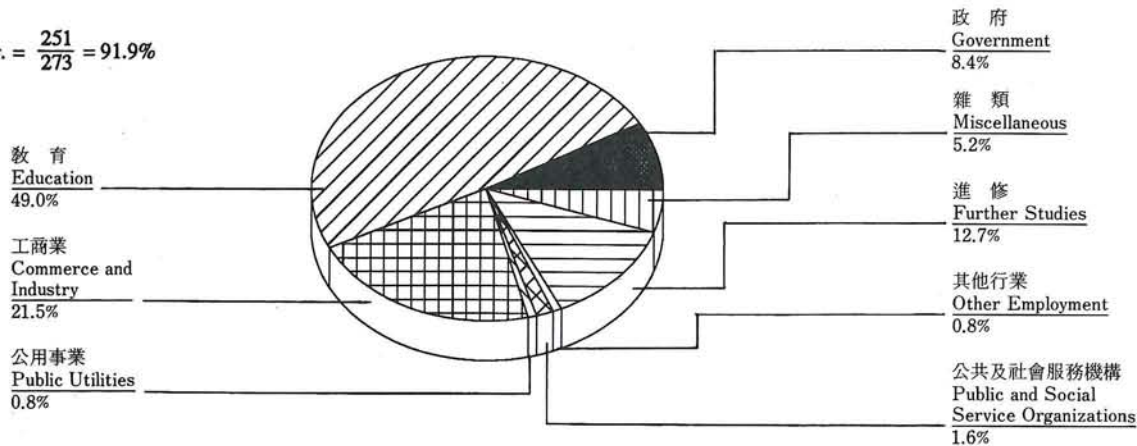

**工商管理學院學士學位畢業生去向**  
**Destinations of first degree holders, Business Administration Faculty**

**1987**

$$r.r. = \frac{207}{224} = 92.4\%$$

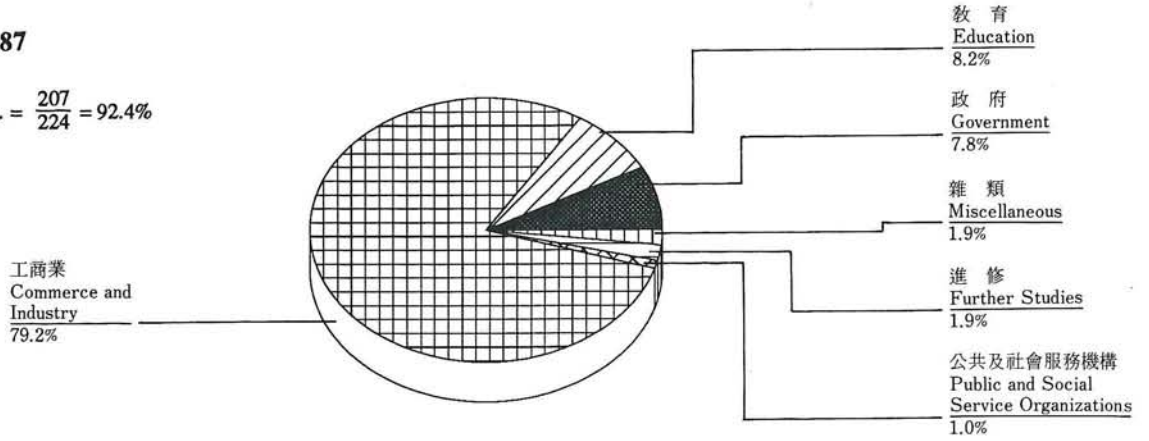

**1988**

$$r.r. = \frac{212}{229} = 92.6\%$$

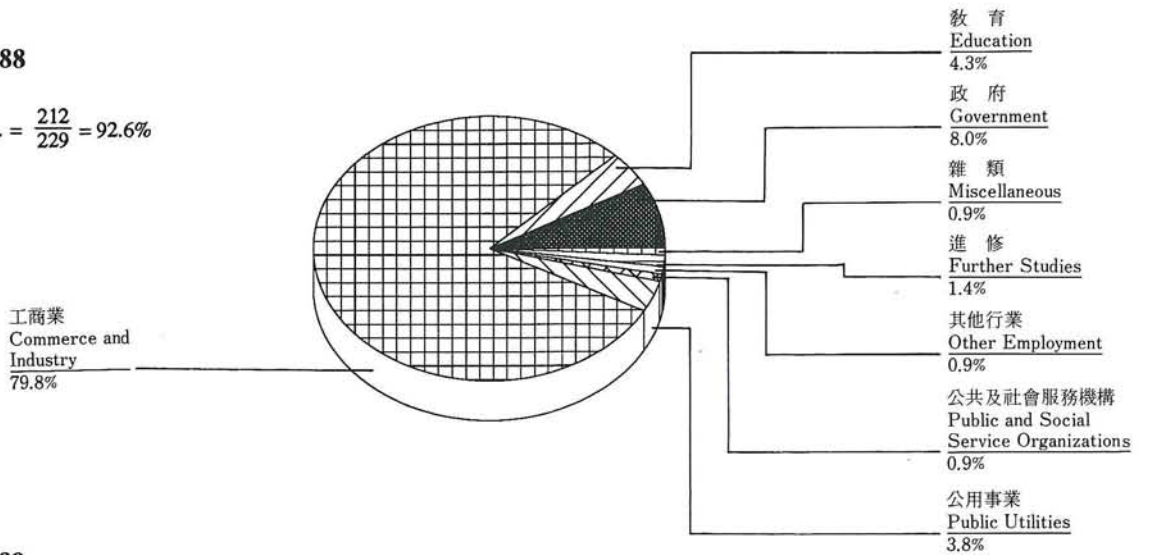

**1989**

$$r.r. = \frac{229}{242} = 94.6\%$$

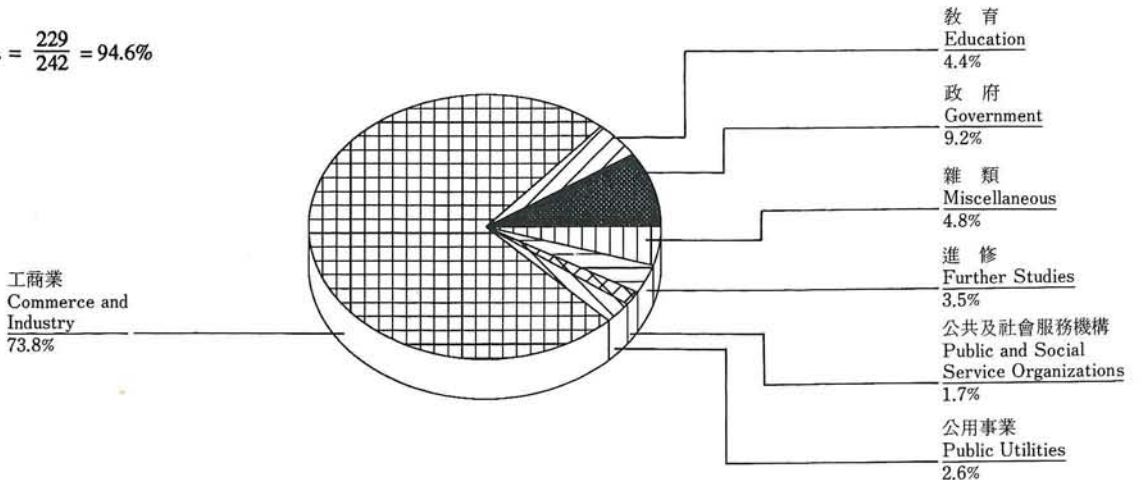



**理學院學士學位畢業生去向**  
**Destinations of first degree holders, Science Faculty**

**1987**

$$r.r. = \frac{309}{329} = 93.9\%$$

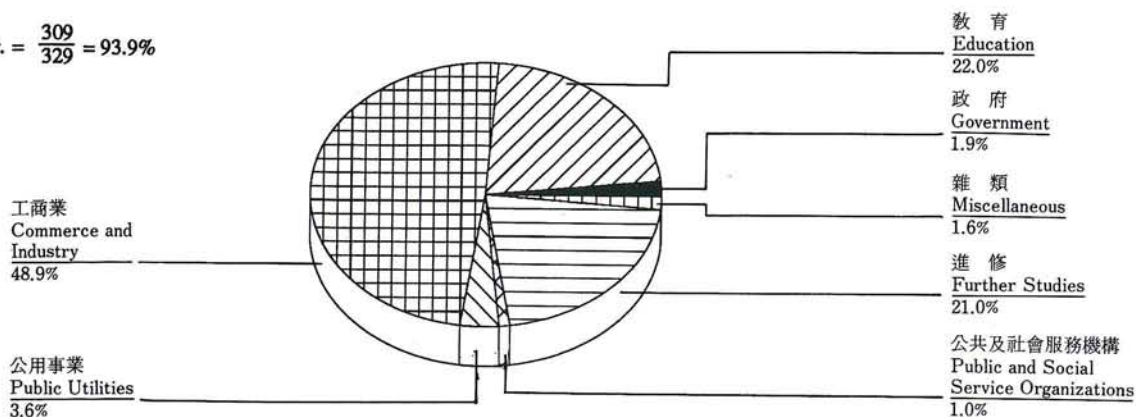

**1988**

$$r.r. = \frac{334}{349} = 95.7\%$$

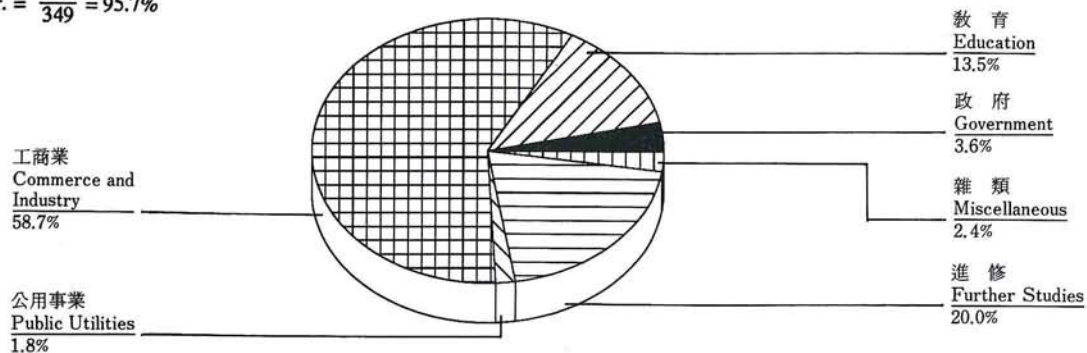

**1989**

$$r.r. = \frac{295}{315} = 93.7\%$$

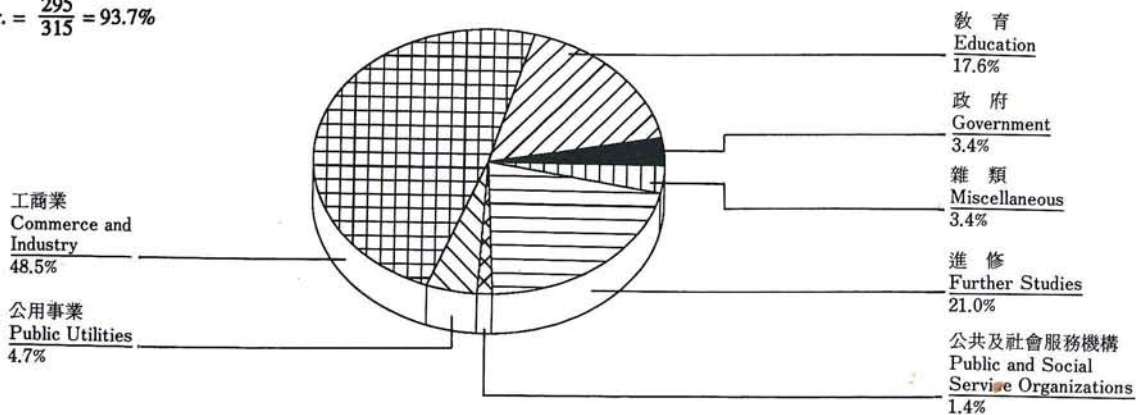

**社會科學院學士學位畢業生去向**  
**Destinations of first degree holders, Social Science Faculty**

**1987**

r.r. =  $\frac{283}{305} = 92.8\%$

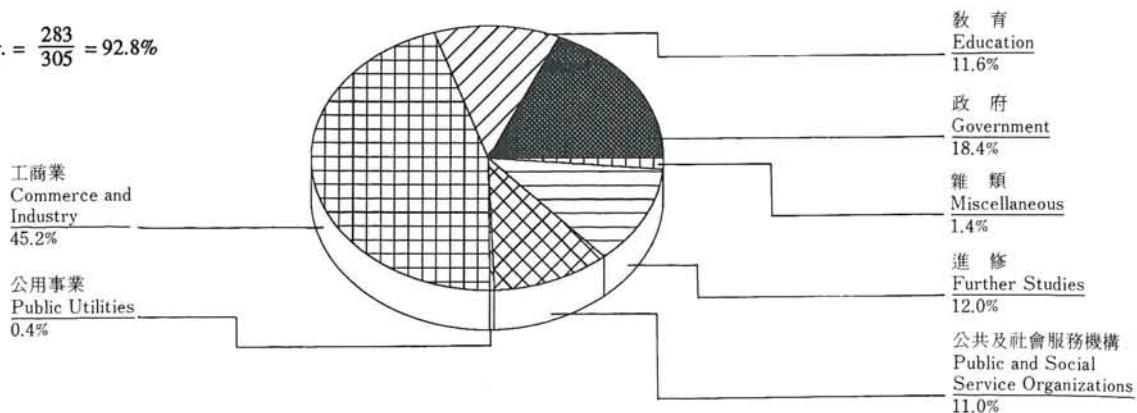

**1988**

r.r. =  $\frac{324}{372} = 87.1\%$

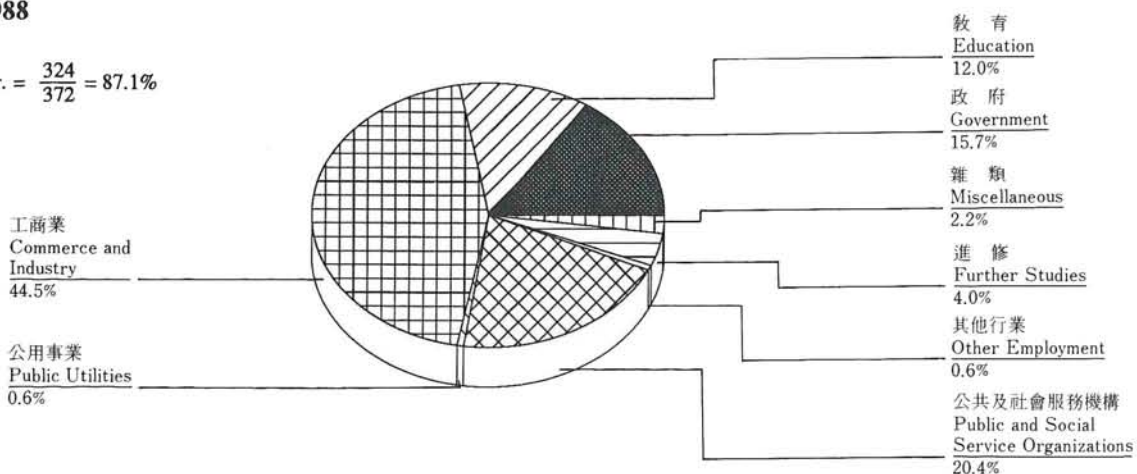

**1989**

r.r. =  $\frac{276}{307} = 89.9\%$

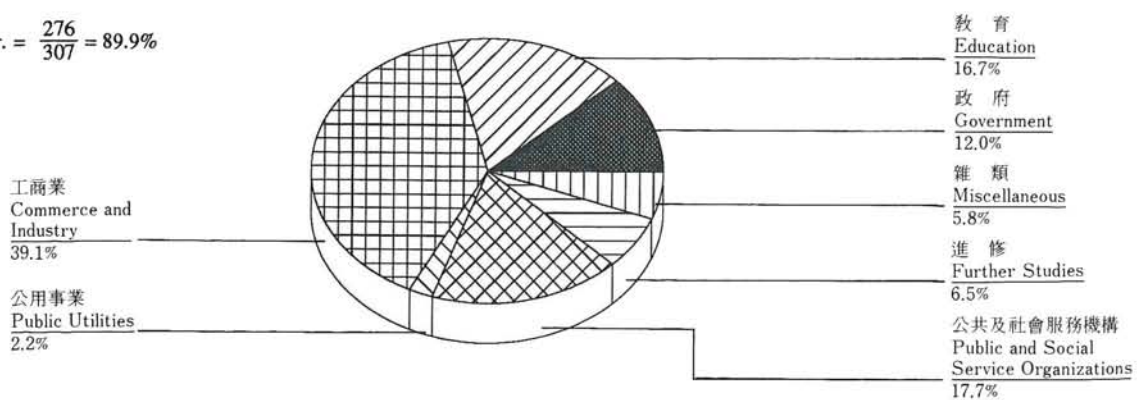

### 高級學位及文憑畢業生去向 一九八七至八九年

#### Destinations of Postgraduate Degree and Diploma Holders 1987 – 89

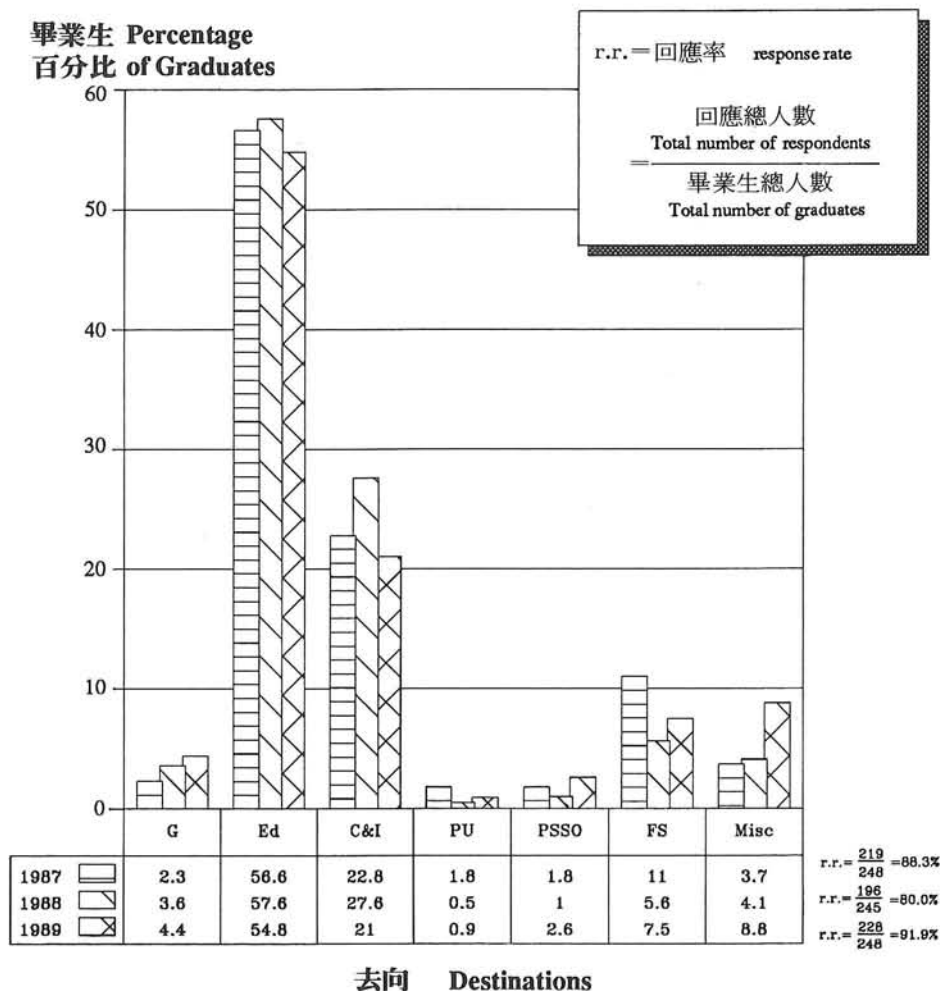

註：不包括兼讀生

G- 政府 (任職助理教育主任者列入「教育」類別)

Ed- 教育

C & I- 工商業

PU- 公用事業

PSSO- 公共及社會服務機構

FS- 進修

Misc- 雜類 (於調查期間旅遊、返回原居地、在海外工作、準備升學、移民、因私人理由而未求職，或仍在找尋合適工作)

Notes: Part-time students are not included

G – Government (not including Assistant Education Officers who are grouped under the Education sector)

Ed – Education

C & I – Commerce and Industry

PU – Public Utilities

PSSO – Public and Social Service Organizations

FS – Further Studies

Misc – Miscellaneous (travelling, returned to their places of origin, employed overseas, preparing for further studies, emigrated abroad, not seeking employment for personal reasons, or still seeking suitable employment at the time of the survey)

### 高級學位畢業生去向 Destinations of postgraduate degree holders

1987

$$r.r. = \frac{109}{132} = 82.6\%$$

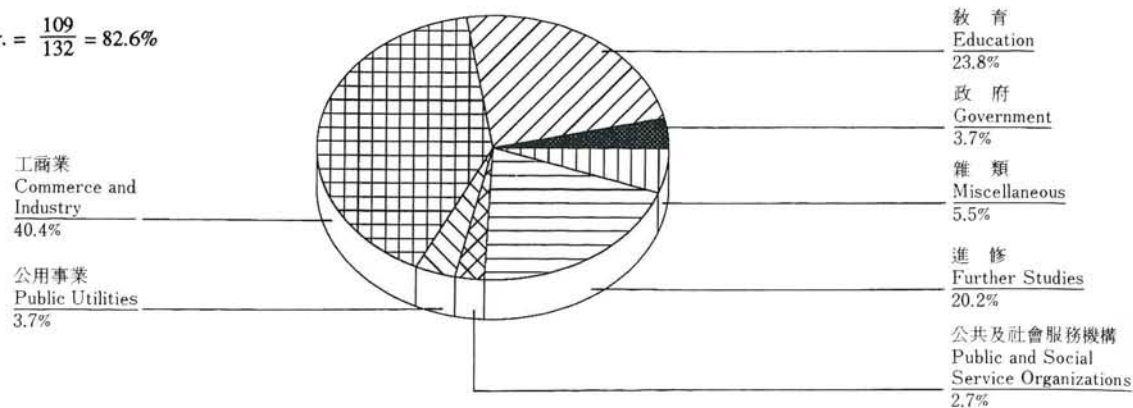

1988

$$r.r. = \frac{98}{141} = 69.5\%$$

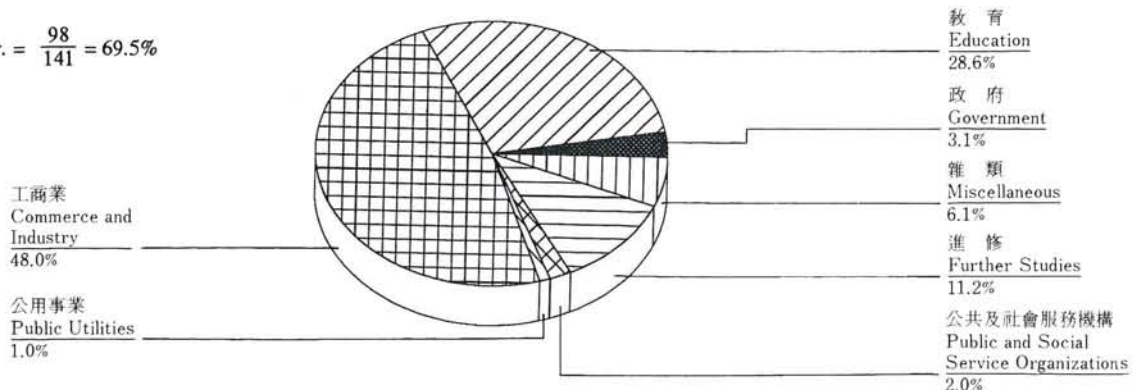

1989

$$r.r. = \frac{126}{136} = 92.6\%$$

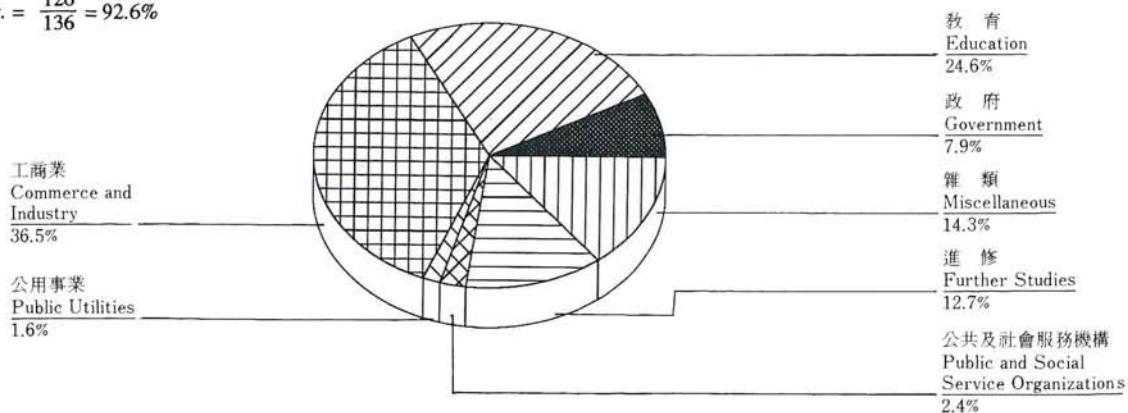

**文憑畢業生去向**  
**Destinations of diploma holders**

**1987**

$$r.r. = \frac{110}{116} = 94.8\%$$

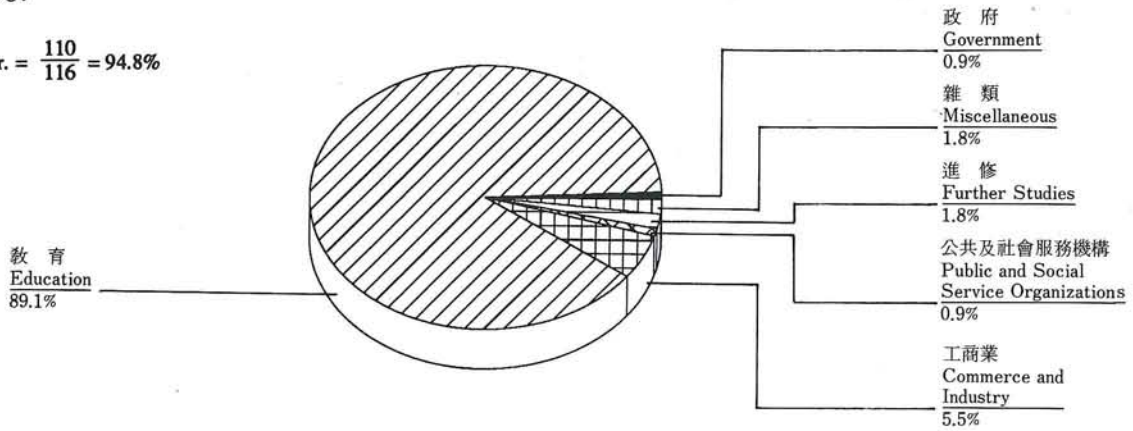

**1988**

$$r.r. = \frac{98}{104} = 94.2\%$$

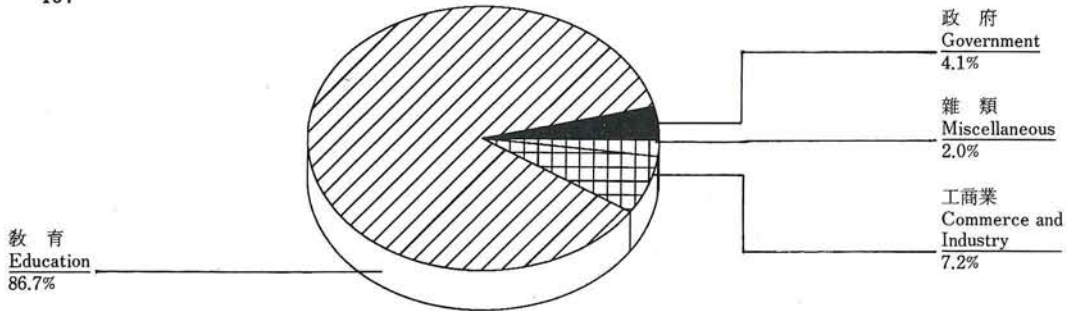

**1989**

$$r.r. = \frac{102}{112} = 91.1\%$$

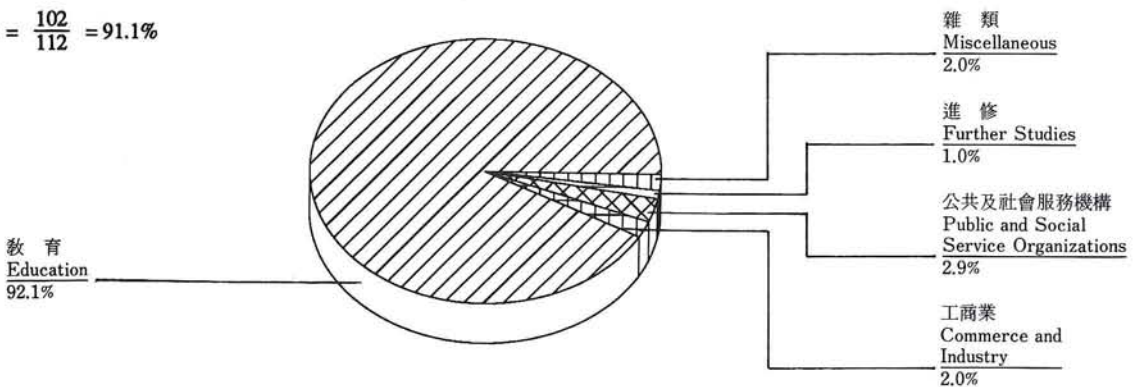

**交換計劃 一九八七至九零年**  
**Exchange Programmes 1987 – 90**

| 計 劃<br>Programme   | 年度<br>Year | 往 訪 人 數<br>No. of Outgoing Students |                   |              | 到 訪 人 數<br>No. of Incoming Visitors |                   |              |
|--|------------|-------------------------------------|-------------------|--------------|-------------------------------------|-------------------|--------------|
|  |            | 學 生<br>Student                      | 畢 業 生<br>Graduate | 合 計<br>Total | 學 生<br>Student                      | 畢 業 生<br>Graduate | 合 計<br>Total |
| 香港中文大學與布朗<br>大學交換計劃  | 1987-88    | -                                   | -                 | -            | 1                                   | -                 | 1            |
| CUHK/Brown University<br>Exchange Programme                  | 1988-89    | -                                   | -                 | -            | 1                                   | -                 | 1            |
|  | 1989-90    | -                                   | -                 | -            | -                                   | -                 | -            |
|  |            |                                     |                   |              |                                     |                   |              |
| 香港中文大學與加州<br>大學(EAP) 交換計劃                                    | 1987-88    | -                                   | 5                 | 5            | 5                                   | 2                 | 7            |
| CUHK/University of<br>California (EAP)<br>Exchange Programme | 1988-89    | 2                                   | 5                 | 7            | 6                                   | 2                 | 8            |
|  | 1989-90    | 8                                   | -                 | 8            | 4                                   | -                 | 4            |
|  |            |                                     |                   |              |                                     |                   |              |
| 香港中文大學與喬治<br>頓大學交換計劃   | 1988-89    | -                                   | -                 | -            | 4                                   | -                 | 4            |
| CUHK/Georgetown<br>University Exchange<br>Programme          | 1989-90    | 1                                   | -                 | 1            | 2                                   | -                 | 2            |
| 香港中文大學參與之<br>國際學生交換計劃  | 1987-88    | 5                                   | -                 | 5            | 5                                   | -                 | 5            |
| CUHK/International<br>Student Exchange<br>Programme, USA     | 1988-89    | 6                                   | -                 | 6            | 6                                   | -                 | 6            |
|  | 1989-90    | 6                                   | -                 | 6            | 5                                   | -                 | 5            |
|  |            |                                     |                   |              |                                     |                   |              |
| 香港中文大學與匹茲<br>堡大學交換計劃   | 1989-90    | 1                                   | -                 | 1            | -                                   | -                 | -            |
| CUHK/University of<br>Pittsburgh Exchange<br>Programme       |            |                                     |                   |              |                                     |                   |              |
| 香港中文大學與創價<br>大學交換計劃  | 1987-88    | 3                                   | -                 | 3            | 3                                   | -                 | 3            |
| CUHK/Soka University<br>Exchange Programme                   | 1988-89    | 3                                   | -                 | 3            | 2                                   | -                 | 2            |
|  | 1989-90    | 3                                   | -                 | 3            | 4                                   | -                 | 4            |
|  |            |                                     |                   |              |                                     |                   |              |

| 計 劃<br>Programme  | 年度<br>Year | 往 訪 人 數<br>No. of Outgoing Students |                 |             | 到 訪 人 數<br>No. of Incoming Visitors |                 |             |
|---|------------|-------------------------------------|-----------------|-------------|-------------------------------------|-----------------|-------------|
|   |            | 學 生<br>Student                      | 畢業生<br>Graduate | 合計<br>Total | 學 生<br>Student                      | 畢業生<br>Graduate | 合計<br>Total |
| 崇基學院與國際基督<br>教大學交換計劃  | 1987-88    | 1                                   | -               | 1           | 1                                   | -               | 1           |
| Chung Chi College/<br>International Christian<br>University Exchange<br>Programme | 1988-89    | 1                                   | -               | 1           | 1                                   | -               | 1           |
|   | 1989-90    | 1                                   | -               | 1           | 1                                   | -               | 1           |
| 崇基學院與慶應大學<br>交換計劃   | 1987-88    | 1                                   | -               | 1           | 1                                   | -               | 1           |
| Chung Chi College/<br>Keio University<br>Exchange Programme                       | 1988-89    | 1                                   | -               | 1           | 1                                   | -               | 1           |
|   | 1989-90    | 1                                   | -               | 1           | 1                                   | -               | 1           |
| 崇基學院與勒蘭斯大<br>學交換計劃  | 1987-88    | 1                                   | -               | 1           | 1                                   | -               | 1           |
| Chung Chi College/<br>Redlands University<br>Exchange Programme                   | 1988-89    | 1                                   | -               | 1           | 1                                   | -               | 1           |
|   | 1989-90    | 1                                   | -               | 1           | -                                   | -               | -           |
| 崇基學院與華盛頓與<br>李大學交換計劃  | 1987-88    | 2                                   | -               | 2           | 2                                   | -               | 2           |
| Chung Chi College/<br>Washington & Lee<br>University Exchange<br>Programme        | 1988-89    | 2                                   | -               | 2           | -                                   | -               | -           |
|   | 1989-90    | 1                                   | -               | 1           | 1                                   | -               | 1           |
| 新亞書院與日本大學<br>交換計劃   | 1987-88    | 2                                   | -               | 2           | 1                                   | -               | 1           |
| New Asia College/<br>Japan Universities<br>Exchange Programme                     | 1988-89    | 2                                   | -               | 2           | 1                                   | -               | 1           |
|   | 1989-90    | 2                                   | -               | 2           | 2                                   | -               | 2           |

| 計 劃<br>Programme  | 年度<br>Year | 往 訪 人 數<br>No. of Outgoing Students |                 |             | 到 訪 人 數<br>No. of Incoming Visitors |                 |             |
|---|------------|-------------------------------------|-----------------|-------------|-------------------------------------|-----------------|-------------|
|   |            | 學 生<br>Student                      | 畢業生<br>Graduate | 合計<br>Total | 學 生<br>Student                      | 畢業生<br>Graduate | 合計<br>Total |
| 二年制工商管理碩士<br>課程與英屬哥倫比亞<br>大學交換計劃<br>2-Year MBA Programme/<br>University of British<br>Columbia Exchange<br>Programme          | 1989-90    | 2                                   | -               | 2           | 1                                   | -               | 1           |
| 二年制工商管理碩士<br>課程與加州大學洛杉<br>磯分校交換計劃<br>2-Year MBA Programme/<br>University of California,<br>Los Angeles, Exchange<br>Programme | 1989-90    | 3                                   | -               | 3           | 3                                   | -               | 3           |
| 二年制工商管理碩士<br>課程與紐約大學工商<br>管理學院交換計劃<br>2-Year MBA Programme/<br>New York University<br>Exchange Programme                      | 1987-88    | 3                                   | -               | 3           | 3                                   | -               | 3           |
|   | 1988-89    | 4                                   | -               | 4           | 4                                   | -               | 4           |
|   | 1989-90    | 4                                   | -               | 4           | 3                                   | -               | 3           |
| 二年制工商管理碩士<br>課程與西安大略大學<br>交換計劃<br>2-Year MBA Programme/<br>University of Western<br>Ontario Exchange<br>Programme             | 1988-89    | 2                                   | -               | 2           | 2                                   | -               | 2           |
|   | 1989-90    | 2                                   | -               | 2           | 2                                   | -               | 2           |
| 聯合書院與印第安那<br>大學交換計劃<br>United College/<br>Indiana University<br>Exchange Programme  | 1987-88    | -                                   | 1               | 1           | -                                   | 1               | 1           |
|   | 1988-89    | -                                   | 1               | 1           | -                                   | -               | -           |
|   | 1989-90    | -                                   | 1               | 1           | -                                   | 1               | 1           |



| 計 劃<br>Programme                    | 年度<br>Year | 往 訪 人 數<br>No. of Outgoing Students |                   |              | 到 訪 人 數<br>No. of Incoming Visitors |                   |              |
|-------------------------------------|------------|-------------------------------------|-------------------|--------------|-------------------------------------|-------------------|--------------|
|                                     |            | 學 生<br>Student                      | 畢 業 生<br>Graduate | 合 計<br>Total | 學 生<br>Student                      | 畢 業 生<br>Graduate | 合 計<br>Total |
| 聯合書院與威廉士大<br>學交換計劃                  | 1987-88    | 1                                   | -                 | 1            | -                                   | 2                 | 2            |
| United College/<br>Williams College | 1988-89    | 1                                   | -                 | 1            | -                                   | 2                 | 2            |
| Exchange Programme                  | 1989-90    | 1                                   | -                 | 1            | -                                   | 2                 | 2            |
| 合計<br>Total                         | 1987-88    | 19                                  | 6                 | 25           | 23                                  | 5                 | 28           |
|                                     | 1988-89    | 25                                  | 6                 | 31           | 29                                  | 4                 | 33           |
|                                     | 1989-90    | 37                                  | 1                 | 38           | 29                                  | 3                 | 32           |

**宿位 一九八七至九零年**  
**Hostel Places 1987 - 90**

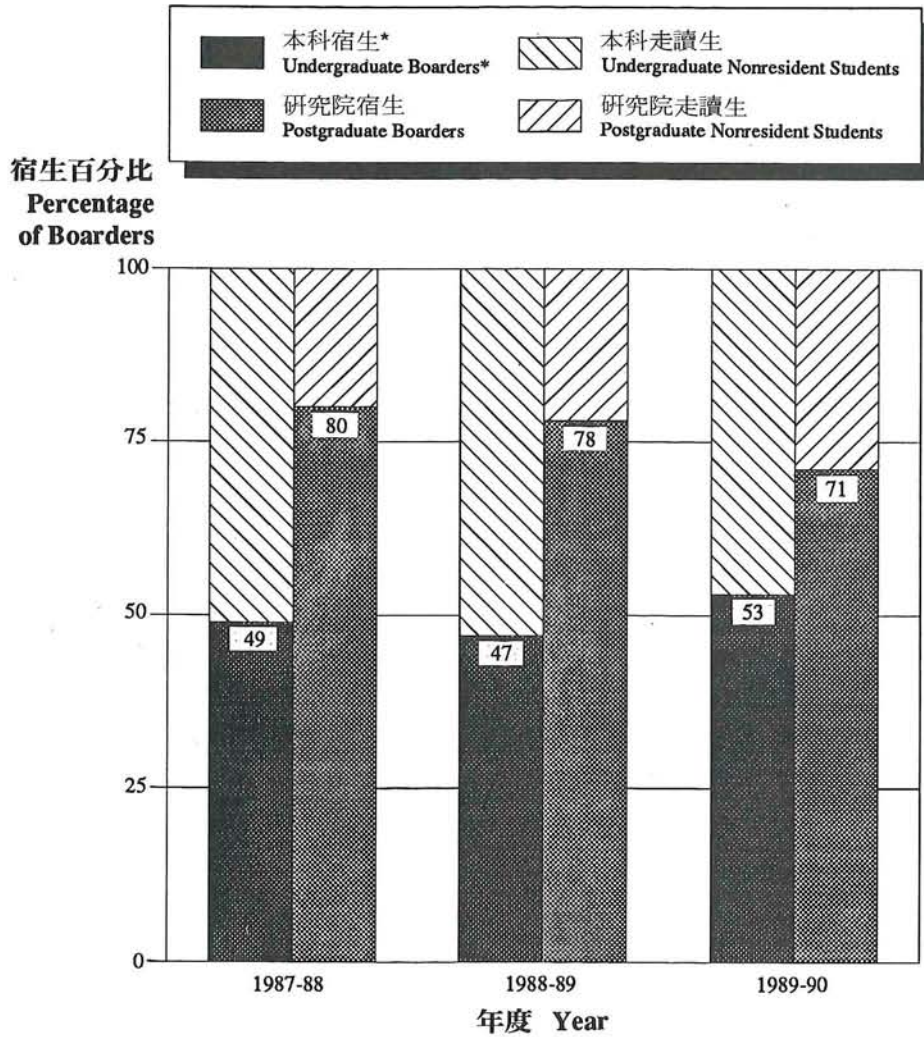

|                           | 1987-88 | 1988-89 | 1989-90 |
|---------------------------|---------|---------|---------|
| 本科走讀生 (Diagonal lines /)  | 2,853   | 3,070   | 2,893   |
| 本科宿生* (Solid black)       | 2,744   | 2,748   | 3,296   |
| 研究院走讀生 (Diagonal lines \) | 67      | 75      | 103     |
| 研究院宿生 (Dotted pattern)    | 260     | 270     | 258     |

**全日制學生人數** Number of Full-time Students  
 (不包括修讀文憑課程者) (Excluding those attending diploma programmes)

註：當年十二月三十一日計算

\*包括少數入住研究院宿舍之本科生

Notes: All figures as at 31st December

\*Including a small number of undergraduates accommodated in the Postgraduate Hall Complex

# 校園建設

*Campus development*

---



## 校園建設 一九八七至九零年

### Campus Development 1987 - 90



**逸夫書院文瀾堂**  
用途：行政及教學  
落成日期：一九八九年七月  
資金來源：邵氏基金會

**Wen Lan Tang, Shaw College**  
Usage: administration and teaching  
Date of completion: July 1989  
Funding source: The Shaw Foundation  
Hong Kong Ltd.



**逸夫書院雅群樓**  
用途：教職員宿舍  
落成日期：一九八九年七月  
資金來源：邵氏基金會

**Ya Qun Lodge, Shaw College**  
Usage: staff quarters  
Date of completion: July 1989  
Funding source: The Shaw Foundation Hong Kong Ltd.



**逸夫書院第一學生宿舍**  
用途：宿舍及康樂設施  
落成日期：一九八九年七月  
資金來源：邵氏基金會

**Student Hostel I, Shaw College**  
Usage: hostel and amenities  
Date of completion: July 1989  
Funding source: The Shaw Foundation Hong Kong Ltd.

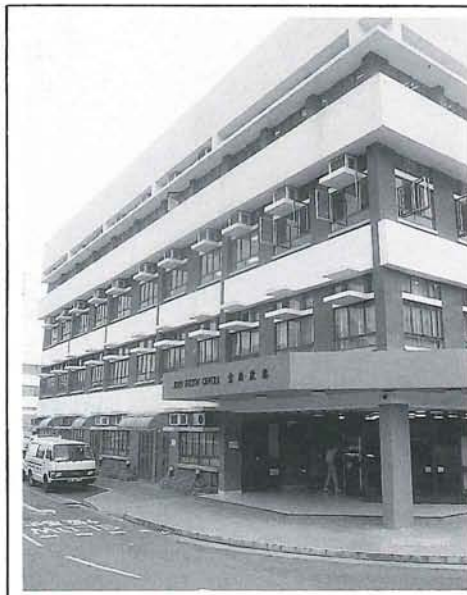
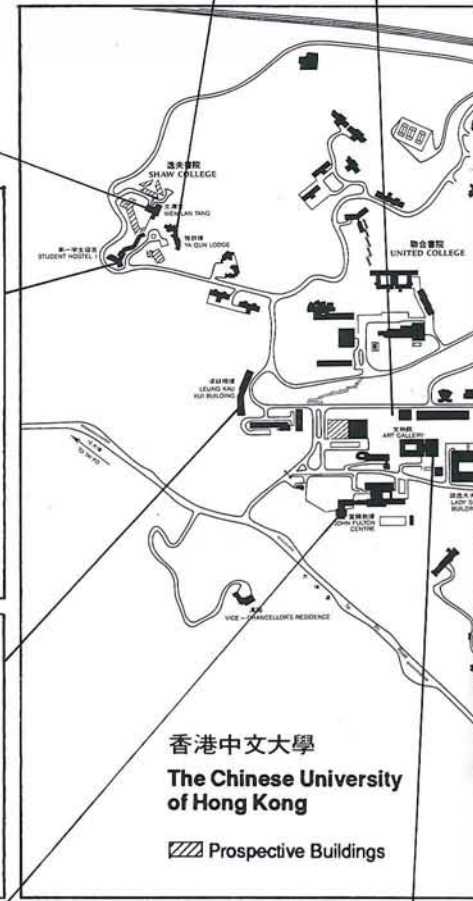

**梁錫琚樓**  
用途：教學  
預計竣工日期：一九九一年第二季  
資金來源：香港政府及梁錫琚博士

**Leung Kau Kui Building**  
Usage: teaching  
Expected date of completion: 2nd quarter 1991  
Funding source: Hong Kong Government and Dr. Leung Kau Kui

**富爾敦樓**  
用途：教職員 / 學生康樂設施  
落成日期：一九八八年十二月  
資金來源：香港政府

**John Fulton Centre**  
Usage: staff/student amenities  
Date of completion: December 1988  
Funding source: Hong Kong Government





**「門」及惠園**  
 用途：美化校園  
 落成日期：一九八七年十二月  
 資金來源：司徒惠博士

**Sculpture and Forum**  
 Usage: landscaping  
 Date of completion: December 1987  
 Funding source: Dr. Szeto Wai

**香港生物科技研究院綜合大樓**  
 用途：研究  
 預計竣工日期：一九九一年第三季  
 資金來源：香港賽馬會（慈善）有限公司

**Hong Kong Institute of Biotechnology Building Complex**  
 Usage: research  
 Expected date of completion: 3rd quarter 1991  
 Funding source: The Hong Kong Jockey Club (Charities) Ltd.



**Lady Shaw Building**  
 Usage: teaching  
 Date of completion: March 1989  
 Funding source: Hong Kong Government and The Shaw Foundation Hong Kong Ltd.

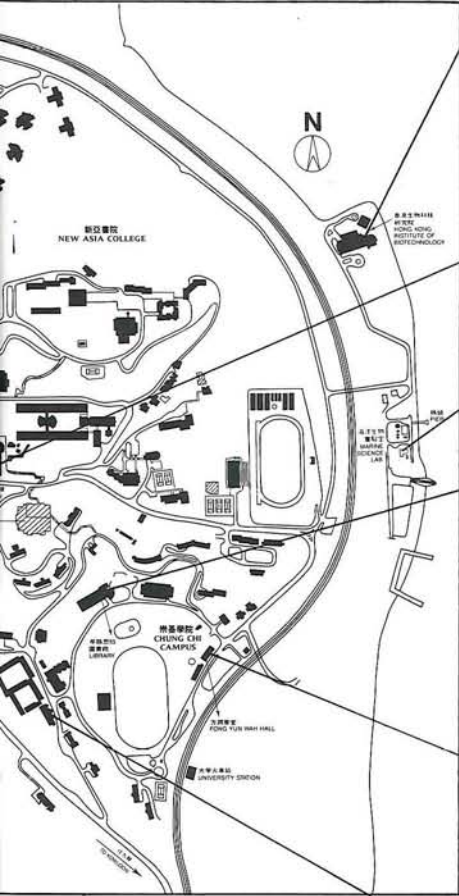

**邵逸夫人樓**  
 用途：教學  
 落成日期：一九八九年三月  
 資金來源：香港政府及邵氏基金會

**海洋科學實驗室擴建部分**  
 用途：教學及研究  
 落成日期：一九八七年七月  
 資金來源：香港政府

**Extension to the Marine Science Laboratory**  
 Usage: teaching and research  
 Date of completion: July 1987  
 Funding source: Hong Kong Government

**牟路思怡圖書館擴建工程**  
 用途：圖書館  
 預計竣工日期：一九九零年第四季  
 資金來源：香港政府

**Extension to the Elisabeth Luce Moore Library**  
 Usage: library  
 Expected date of completion: 4th quarter 1990  
 Funding source: Hong Kong Government



**方潤華堂**  
 用途：教學  
 落成日期：一九九零年二月  
 資金來源：中大及方樹福堂基金會

**Fong Yun Wah Hall**  
 Usage: teaching  
 Date of completion: February 1990  
 Funding source: CUHK and Fong Shu Fook Tong Foundation

**文物館擴建部分**  
 用途：文物館  
 落成日期：一九八八年七月  
 資金來源：林炳炎基金會

**Extension to the Art Gallery**  
 Usage: art gallery  
 Date of completion: July 1988  
 Funding source: B.Y. Lam Foundation Ltd.

**崇基學院教學樓群重建工程第一期**  
 用途：教學  
 預計竣工日期：一九九一年第三季  
 資金來源：香港政府及許讓成先生紀念基金

**Redevelopment of Teaching Buildings of Chung Chi College, Phase I**  
 Usage: teaching  
 Expected date of completion: 3rd quarter 1991  
 Funding source: Hong Kong Government and Mr. Hui Yeung-shing Memorial Endowment Fund



## 一九八七至九零年間獲批准之新計劃

| 計 劃               | 資金來源     | 預計竣工日期                     | 用 途  |
|-------------------|----------|----------------------------|------|
| 一、已獲撥款並將動工之計劃     |          |                            |      |
| 昆棟樓               | 陳昆棟慈善基金會 | 一九九一年第三或第四季                | 賓館   |
| 逸夫書院第三座學生宿舍(宿位三百) | 政府       | 一九九一年第四季                   | 學生宿舍 |
| 逸夫書院大講堂           | 邵氏基金會    | 一九九一年第四季                   | 教學   |
| 大學圖書館擴建第一期        | 政府       | 一九九一年第四季                   | 圖書館  |
| 工科綜合大樓第一期         | 政府       | 一九九二年第一季                   | 教學   |
| 崇基學院教學樓群重建第二期     | 政府       | 一九九三年第一季<br>(視乎第一期重建工程之進度) | 教學   |
| 二、籌建中之計劃          |          |                            |      |
| 大學運動場裝置泛光燈        | 政府及大學基金  | 一九九一年第二季                   | 體育運動 |
| 諸種關於工程設施之小規模工程    | 政府       | 一九九一年第三季                   | 工程設施 |

## New Projects Approved During 1987 – 90

| Project   | Funding Source                      | Expected Date of Completion                              | Usage                |
|---|-------------------------------------|--|----------------------|
| <i>I. Projects fully approved and awaiting construction work to start</i> |                                     |  |                      |
| Chan Kwan-tung Inter-University Hall                                      | Chan Kwan-tung Charitable Fund Ltd. | 3rd/4th quarter 1991                                     | Domestic             |
| Third student hostel (for 300) at Shaw campus                             | Government                          | 4th quarter 1991   | Student hostel       |
| Shaw College lecture theatre  | The Shaw Foundation Hong Kong Ltd.  | 4th quarter 1991   | Teaching             |
| Extension to the University Library, phase I                              | Government                          | 4th quarter 1991   | Library              |
| An academic building for engineering studies, phase I                     | Government                          | 1st quarter 1992   | Teaching             |
| Redevelopment of teaching buildings of Chung Chi College, phase II        | Government                          | 1st quarter 1993<br>(Dependent on phase I redevelopment) | Teaching             |
| <i>II. Projects under active planning and design</i>                      |                                     |  |                      |
| Floodlighting of University stadium                                       | Government & University funds       | 2nd quarter 1991   | Physical education   |
| Minor projects on various engineering services                            | Government                          | 3rd quarter 1991   | Engineering services |

| 計 劃            | 資金來源       | 預計竣工日期                     | 用 途        |
|----------------|------------|----------------------------|------------|
| 曙光樓            | 蔣震先生       | 一九九二年第二季                   | 學人宿舍       |
| 壁球場館           | 政府及啓裕昌有限公司 | 一九九二年第三季                   | 體育運動       |
| 崇基學院宿舍重建第一期    | 政府及私人捐贈    | 一九九二年第三季                   | 學生宿舍       |
| 新亞書院錢穆圖書館擴建    | 政府         | 一九九二年第四季                   | 圖書館        |
| 大學圖書館擴建第二期     | 政府         | 一九九三年第一季                   | 圖書館及其他學術用途 |
| 崇基學院教學樓群重建第三期  | 政府         | 一九九四年第一季<br>(視乎第二期重建工程之進度) | 教學         |
| 三、政府原則上批准開展之計劃 |            |                            |            |
| 工科綜合大樓第二期      | 政府         | 視乎大學及理工教育資助委員會何時全面批准該計劃    | 教學         |
| 崇基學院教學樓群重建第四期  | 政府         | 視乎大學及理工教育資助委員會何時全面批准該計劃    | 教學         |



| Project   | Funding Source   | Expected Date of Completion  | Usage                        |
|---|--|--|------------------------------|
| Chiangs Building  | Private donation by Mr. Chiang Chen                      | 2nd quarter 1992   | Domestic                     |
| A squash centre   | Government & private contribution by Kai Yue Cheong Ltd. | 3rd quarter 1992   | Physical education           |
| Redevelopment of hostels at Chung Chi College, phase I              | Government & private contribution                        | 3rd quarter 1992   | Student hostel               |
| Extension to the Chien Mu Library at New Asia College               | Government   | 4th quarter 1992   | Library                      |
| Extension to the University Library, phase II                       | Government   | 1st quarter 1993   | Library & other academic use |
| Redevelopment of teaching buildings of Chung Chi College, phase III | Government   | 1st quarter 1994<br>(Dependent on phase II redevelopment)            | Teaching                     |
| <i>III. Projects given approval-in-principle status by UPGC</i>     |  |  |                              |
| An academic building for engineering studies, phase II              | Government   | Dependent on when full approval to proceed would be accorded by UPGC | Teaching                     |
| Redevelopment of teaching buildings of Chung Chi College, phase IV  | Government   | Dependent on when full approval to proceed would be accorded by UPGC | Teaching                     |



## 主要捐贈

### *Major donations*

---



### 主要捐贈（港幣五十萬元或以上\*） 一九八七至九零年

| 捐 助 者    | 認捐金額（除特別註明外，<br>以港幣為計算單位）                     | 摘 要   |
|----------|---|---|
| 無名氏      | 500,000                                       | 捐助神學組。                                      |
| 無名氏      | 405,777.29<br>加幣30,407.36及<br>歐洲貨幣單位55,046.44 | 資助中國文化研究所成立「譯叢工作坊」及有關活動。                    |
| 林炳炎基金會   | 1,500,000                                     | 資助裝修中國文化研究所擴建部分。                            |
| 陳昆棟慈善基金會 | 4,300,000                                     | 資助大學興建新賓館，供交換及訪問學者住宿。                       |
| 鄭榮斌夫人    | 2,000,000                                     | 贊助兒科學系之「香港兒童骨髓移植基金」。                        |
| 蔣震先生     | 12,000,000                                    | 資助大學興建賓館，供訪問學人住宿。                           |
| 裘槎基金會    | 2,220,000                                     | 資助購置資訊技術研究設備。                               |
|          | 738,810                                       | 資助生理學系一名講座教授之研究計劃。                          |
|          | 714,540                                       | 資助病理解剖及細胞學系一名高級講師與藥理學系一名講師合作關於鼻咽癌之一項研究計劃。   |
|          | 1,600,000                                     | 捐助生物化學系一名高級講師與中山大學生物系合作關於魚類無性繁殖及生長素之一項研究計劃。 |

\* 五十萬元以下之捐款及其他捐贈未能盡錄，詳情請參閱期內之《中文大學校刊》。現臚列之主要捐贈，皆於一九九零年七月之前獲大學校董會接納。

## Major Donations (HK\$500,000 or above\*) 1987 – 90

| Donor(s)                            | Amount Pledged (in HK\$ unless otherwise stated)   | Particulars   |
|-------------------------------------|--|---|
| An anonymous donor                  | 500,000  | Donation for the Theology Division.   |
| An anonymous donor                  | 405,777.29<br>& CAN\$30,407.36<br>& XEU\$55,046.44 | Donation for the establishment of the "Renditions Workshop" and related programmes at the Institute of Chinese Studies.   |
| The B.Y. Lam Foundation Ltd.        | 1,500,000  | Donation for the decoration and renovation of the extension to the Institute of Chinese Studies.  |
| Chan Kwan Tung Charitable Fund Ltd. | 4,300,000  | Donation for building a new Inter-University Hall to accommodate exchange scholars and academic visitors.   |
| Mrs. Cheng Jung Pin                 | 2,000,000  | Donation for the "Hong Kong Paediatric Bone Marrow Transplant Fund" of the Department of Paediatrics.   |
| Mr. Chiang Chen                     | 12,000,000   | Donation for the construction of a guest house for academic visitors.   |
| The Croucher Foundation             | 2,220,000  | Donation for the purchase of equipment for information technology research.   |
|                                     | 738,810  | Donation for a research project undertaken by a professor of physiology.  |
|                                     | 714,540  | Donation for a research project on "Analysis and Cloning of Oncogenes in Nasopharyngeal Carcinoma" undertaken by a senior lecturer in anatomical and cellular pathology and a lecturer in pharmacology.   |
|                                     | 1,600,000  | Donation for a research project on "Cloning of Fish and Growth Hormone and its Expression in E. Coli and Transgenic Fish" undertaken by a senior lecturer in biochemistry, in cooperation with the Department of Biology, Zhongshan University. |

\* Donations in kind and donations under \$500,000 in the period were too numerous to record in this report. Details can be found in the *Chinese University Bulletin* published quarterly by the University from 1987 to 1990. All donations listed here were accepted by the University Council before July 1990.

| 捐 助 者                     | 認捐金額 ( 除特別註明外，<br>以港幣為計算單位 ) | 摘 要   |
|---------------------------|------------------------------|---|
|                           | 2, 100, 000                  | 資助大學自一九八九年，聘任一位資訊工程學訪問教授，為期三年。                                  |
| 大和海外財務有限公司                | 2, 000, 000                  | 捐設基金，以其收益設「大和銀行集團獎學金」數項，自一九八九至九零年度起，每年頒予獲選往日本修讀日文或參加文化交流計劃之本科生。 |
| 許讓成先生遺贈暨許國浩先生、許少榮先生及許建華先生 | 10, 000, 000                 | 捐設「許讓成先生紀念基金」，供研究及教育之用。   |
| 鄧煜懷先生遺贈                   | 5, 000, 000                  | 資助醫學院設立放射線研究小組。   |
| 方樹福堂基金會                   | 1, 300, 000                  | 資助興建「方潤華堂」。   |
| 香港商業廣播有限公司                | 500, 000                     | 贊助兒科學系之「兒童癌病基金」。  |
| 香港賽馬會 ( 慈善 ) 有限公司         | 8, 000, 000                  | 繼續資助中藥研究中心一項關於治療心血管疾病藥物之研究，用作一九八八年十月至一九九一年九月之經費。                |
|                           | 170, 000, 000                | 資助興建香港生物科技研究院綜合大樓及該院首五年運作經費。                                    |

| Donor(s)   | Amount Pledged (in HK\$<br>unless otherwise stated) | Particulars   |
|--|---|---|
|  | 2,100,000   | Donation for the appointment of a visiting professor of information engineering for three years from 1989.  |
| Daiwa Overseas Finance Ltd.  | 2,000,000   | Donation for the establishment of an endowment fund, the accrued interest from which will be used for the award annually of a number of "Daiwa Bank Group Awards for Japanese Studies/Cultural Exchange Programmes in Japan" to undergraduates who have been selected for the programme from 1989-90. |
| Estate of the late Mr. Hui<br>Yeung Shing,<br>Mr. Hui Kwok-hau,<br>Mr. Hui Siu-wing and<br>Mr. Hui Kin-wah | 10,000,000  | Donation for the establishment of the "Hui Yeung Shing Memorial Endowment Fund" for research and educational purposes.  |
| Estate of the late Tang Yuk<br>Wai   | 5,000,000   | Donation for the establishment of a radiological research unit under the Faculty of Medicine.   |
| Fong Shu Fook Tong<br>Foundation   | 1,300,000   | Donation towards the construction cost of the "Fong Yung Wah Hall".   |
| Hong Kong Commercial<br>Broadcasting Co., Ltd.   | 500,000   | Donation to the "Children's Cancer Fund" of the Department of Paediatrics.  |
| The Hong Kong Jockey Club<br>(Charities) Ltd.  | 8,000,000   | Further donation for the Cardiovascular Drug and Tranquilliser Research Project undertaken by the Chinese Medicinal Material Research Centre for the period 1st October 1988 to 30th September 1991.  |
|  | 170,000,000   | Donation for the construction of a building complex to house the activities of the Hong Kong Institute of Biotechnology, and for the institute's operating expenses in the first five years.  |

| 捐 助 者    | 認捐金額 ( 除特別註明外，<br>以港幣為計算單位 ) | 摘 要   |
|----------|------------------------------|---|
| 香港荳品有限公司 | 1, 000, 000                  | 資助香港生物科技研究院關於食物及營養之研究。                        |
| 胡格非先生    | 780, 000                     | 繼續贊助崇基學院「胡格非教育基金」。                            |
| 香港政府工業署  | 1, 500, 000                  | 資助電子計算學系與香港大學機械工程學系之一項合作研究計劃，發展電腦輔助設計及生產系統。   |
| 殷遜藥廠     | 600, 000                     | 資助內科學系一項研究計劃。                                 |
| 郭勤林先生    | 500, 000                     | 捐設獎學基金，以其收益設「郭靖堂獎學金」十項，自一九八八至八九年度起，每年頒予大學本科生。 |
| 利國偉爵士    | 5, 000, 000                  | 贊助香港生物科技研究院之研究經費。                             |
|          | 7, 500, 000                  | 捐建崇基學院一幢新學生宿舍。                                |
| 馬佩嫻醫生    | 1, 000, 000                  | 贊助化學系一名講座教授及一名講師之學術研究活動。                      |
|          | 1, 000, 000                  | 贊助理工研究所一位名譽研究員之學術研究活動。                        |



| Donor(s)                                    | Amount Pledged (in HK\$ unless otherwise stated) | Particulars  |
|---|--|--|
| The Hong Kong Soya Bean Products Co., Ltd.  | 1,000,000  | Donation for food and nutrition research undertaken by the Hong Kong Institute of Biotechnology.   |
| Mr. C.F. Hu                                 | 780,000  | Further donation towards the C.F. Hu Education Endowment Fund established at Chung Chi College.  |
| Industry Department of Hong Kong Government | 1,500,000  | Donation for a research project on "The Coordinated Development Programme on Computer Aided Design and Computer Aided Manufacture (CAD/CAM) Technology" undertaken by the Department of Computer Science jointly with the Department of Mechanical Engineering of the University of Hong Kong. |
| Janssen Pharmaceutica                       | 600,000  | Donation for a research project on "Nebivolol/Ketanserin Studies in Hong Kong" undertaken by the Department of Medicine.   |
| Mr. Frank L. Kwok                           | 500,000  | Donation to set up an endowment fund, the accrued interest from which will be used for the award of 10 "Kwok Ching Tong Scholarships" annually to undergraduates with effect from 1988-89.   |
| Sir Q. W. Lee                               | 5,000,000  | Donation to support research programmes at the Hong Kong Institute of Biotechnology Limited.   |
|   | 7,500,000  | Donation for the construction of a new student hostel at Chung Chi College.  |
| Dr. Ma Pui-han                              | 1,000,000  | Donation for research and other academic activities undertaken by a professor of chemistry and a lecturer in chemistry.  |
|   | 1,000,000  | Donation in support of the research and academic activities of an honorary research fellow at the Institute of Science and Technology.   |

| 捐 助 者             | 認捐金額（除特別註明外，<br>以港幣為計算單位） | 摘 要   |
|-------------------|---------------------------|---|
| 默沙東（亞洲）有限公司       | 美元131,500                 | 資助內科學系之一項研究計劃。  |
| 麥當勞有限公司           | 560,600                   | 贊助兒科學系之「香港兒童骨髓移植基金」。  |
| 太平洋保險有限公司         | 1,000,000                 | 捐設「學生活動基金」。   |
| 肺塵埃沉著病賠償基金<br>委員會 | 800,000                   | 資助社區及家庭醫學系一名高級講師關於如何降低建築工業中之危害健康因素之研究計劃。                      |
| 聲寶—樂聲（香港）有限公司     | 1,000,000                 | 資助外科學系設立一客座教授席。   |
| 邵氏基金會             | 1,000,000                 | 贊助兒科學系之「兒童癌病基金」。  |
| 邵逸夫爵士             | 10,000,000                | 繼續資助逸夫書院之成立經費（基金會原已捐款一億元）。                                    |
| 邵逸夫爵士             | 13,500,000                | 資助興建逸夫書院一幢新學生宿舍。  |
| 崇源置業有限公司          | 600,000                   | 資助內科學系之教學及一般開支。   |
| 宋漢璋先生紀念獎學基金<br>會  | 540,543.86                | 捐設基金，以其收益設獎學金或研究資助，由一九八九至九零年度起，每年頒予學生或教員，資助其攻讀或研究與銀行及保險有關之學科。 |

| Donor(s)  | Amount Pledged (in HK\$ unless otherwise stated) | Particulars  |
|---|--|--|
| Merck Sharp & Dohme (Asia) Ltd.                         | US\$131,500                                      | Donation for the Enalapril Study undertaken by the Department of Medicine.   |
| McDonald's Restaurants (Hong Kong) Ltd.                 | 560,600  | Donation for the "Hong Kong Paediatric Bone Marrow Transplant Fund" of the Department of Paediatrics.  |
| The Pacific Insurance Co., Ltd.                         | 1,000,000  | Donation for the establishment of a "Student Activities Fund".   |
| Pneumoconiosis Compensation Fund Board                  | 800,000  | Donation for a research project on "Global Strategy for the Reduction of Health Risks in the Construction Industry: Pneumoconiosis and Related Health Risks" undertaken by a senior lecturer in community and family medicine.   |
| Sharp-Roxy (Hong Kong) Ltd.                             | 1,000,000  | Donation for the establishment of a visiting professorship in the Department of Surgery.   |
| The Shaw Foundation Hong Kong Ltd.                      | 1,000,000  | Donation to the "Children's Cancer Fund" of the Department of Paediatrics.   |
|   | 10,000,000                                       | Further donation towards the establishment of Shaw College (the original donation from the Foundation was HK\$100,000,000).  |
| Sir Run Run Shaw  | 13,500,000                                       | Donation towards the construction cost of a new student hostel at Shaw College.  |
| Shung Yuen Land Investment Co., Ltd.                    | 600,000  | Donation for educational and general purposes for the Department of Medicine.  |
| Mr. Sung Han-chang Memorial Scholarship Foundation Ltd. | 540,543.86                                       | Donation for the establishment of an endowment fund, the accrued interest from which will be used for the award of one or more "Mr. Sung Han-chang Memorial Scholarship/Research Grant" to student(s)/staff to pursue studies or conduct research in banking/insurance or other related subjects, annually with effect from 1989-90. |

| 捐 助 者     | 認捐金額 ( 除特別註明外，<br>以港幣為計算單位 ) | 摘 要                              |
|-----------|------------------------------|----------------------------------|
| 王澤森先生     | 1, 000, 000                  | 贊助外科學系之教學及一般經費。                  |
| 偉倫基金會有限公司 | 500, 000                     | 資助矯形外科及創傷學系一項關於骨質疏鬆之研究計劃。        |
|           | 500, 000                     | 資助外科學系設立「利永立心臟外科手術紀念基金」。         |
|           | 11, 150, 000                 | 捐設「偉倫訪問教授及訪問學人計劃」。               |
| 世界衛生組織    | 663, 205及<br>美元1, 500        | 資助生物化學系一名講座教授關於自植物分離調節生育藥劑之研究計劃。 |

| Donor(s)   | Amount Pledged (in HK\$ unless otherwise stated) | Particulars   |
|--|--|---|
| Mr. Wilson T.S. Wang   | 1,000,000  | Donation for educational and general purposes in the Department of Surgery.   |
| Wei Lun Foundation Ltd.<br>(Formerly named as<br>Wideland Foundation Ltd.) | 500,000  | Donation for a research project on osteoporosis undertaken by the Department of Orthopaedics and Traumatology.  |
|  | 500,000  | Donation for the establishment of "The Philip W.L. Lee Open Heart Surgery Memorial Fund" in the Department of Surgery.  |
|  | 11,150,000                                       | Donation for the establishment of the "Wei Lun Visiting Professorship/Fellowship Programme".  |
| World Health Organization  | 663,205<br>&US\$1,500                            | Donation for a project on "A Multi-centre Collaborative Approach for the Isolation of Fertility Regulating Agents from Plants" undertaken by a professor of biochemistry. |



# 賬 項

## *Annual accounts*

---

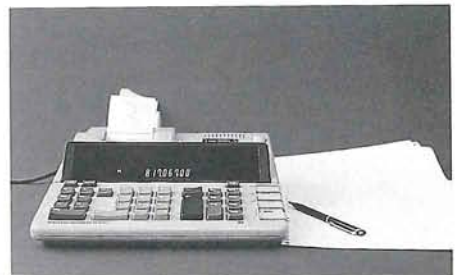

**資產負債表** 一九八七至一九九零年各年度六月三十日**Balance Sheet as at 30th June, 1987 – 1990**

|   | <u>1990</u><br>\$  | <u>1989</u><br>\$  | <u>1988</u><br>\$  | <u>1987</u><br>\$  |
|---|--------------------|--------------------|--------------------|--------------------|
| 固定資產<br>FIXED ASSETS  | 4                  | 4                  | 4                  | 4                  |
| 上市證券投資(成本)<br>LISTED INVESTMENTS AT COST  | 21,689,065         | 21,689,065         | 21,648,994         | 15,755,019         |
| 市<br>Market Value at  |                    |                    |                    |                    |
| 30.6.1990 - \$35,404,251  |                    |                    |                    |                    |
| 30.6.1989 - \$23,286,178  |                    |                    |                    |                    |
| 30.6.1988 - \$25,963,294  |                    |                    |                    |                    |
| 30.6.1987 - \$22,191,663  |                    |                    |                    |                    |
| 存投資經理公司款項<br>FUNDS WITH INVESTMENT MANAGERS   | 75,961,467         | 68,696,504         | 64,079,303         | 62,044,078         |
| 投資大學及理工學院電算機中心有限公司<br>INVESTMENT IN UNIVERSITY AND POLYTECHNIC<br>COMPUTER CENTRE LIMITED | 500                | 500                | 500                | 500                |
| 流動資產<br>CURRENT ASSETS  |                    |                    |                    |                    |
| 期末盤存<br>Stocks in Hand  | -                  | -                  | 516,151            | 487,762            |
| 教職員借款<br>Staff Loans  | 116,470,000        | -                  | -                  | -                  |
| 學生借款<br>Student Loans   | 962,175            | 993,491            | 910,956            | 773,375            |
| 應收賬及預付賬項<br>Debtors and Payments in Advance   | 17,601,033         | 9,339,039          | 6,107,906          | 4,053,774          |
| 應收政府撥款<br>Government Grants Receivable  | 30,120,570         | 11,284,311         | -                  | -                  |
| 銀行及財務機構存款<br>Cash at Banks and with Financial Institutions                                |                    |                    |                    |                    |
| 定期存款<br>Time Deposits   | 391,532,760        | 258,253,763        | 203,172,613        | 187,213,348        |
| 活期及儲蓄存款<br>Current and Savings Accounts   | 14,609,849         | 5,031,231          | 7,855,777          | 9,134,614          |
| 現金<br>Cash in Hand  | 113,929            | 87,881             | 84,439             | 89,536             |
|   | <u>571,410,316</u> | <u>284,989,716</u> | <u>218,647,842</u> | <u>201,752,409</u> |
| 減：流動負債<br>LESS : CURRENT LIABILITIES  |                    |                    |                    |                    |
| 轉借予教職員之銀行貸款<br>Bank Loans for on-lending to Staff   | 116,470,000        | -                  | -                  | -                  |
| 應付賬項及應付費用<br>Creditors and Accrued Expenses   | 213,085,649        | 73,462,530         | 49,956,604         | 39,064,881         |
| 應付教職員公積金計劃款項<br>Amount due to Staff Superannuation Scheme                                 | 8,119,668          | 6,113,275          | 3,844,315          | 4,452,948          |
| 應退政府撥款<br>Government Grants Returnable  | -                  | -                  | 3,860,455          | 3,592,689          |
|   | <u>337,675,317</u> | <u>79,575,805</u>  | <u>57,661,374</u>  | <u>47,110,518</u>  |
| 流動資產淨額<br>NET CURRENT ASSETS  | <u>233,734,999</u> | <u>205,413,911</u> | <u>160,986,468</u> | <u>154,641,891</u> |
| 總資產淨額<br>TOTAL NET ASSETS   | <u>331,386,035</u> | <u>295,799,984</u> | <u>246,715,269</u> | <u>232,441,492</u> |



| 相當於<br>REPRESENTED BY   | 1990<br>\$  | 1989<br>\$  | 1988<br>\$  | 1987<br>\$  |
|---|-------------|-------------|-------------|-------------|
| 校園建設金賬面值<br>CAPITAL FUND  | 4           | 4           | 4           | 4           |
| 儲備金<br>RESERVES   | 26,260,509  | 38,940,405  | 12,488,212  | 18,225,893  |
| 大學及理工教育資助委員會撥款平衡賬<br>UPGC EQUALIZATION ACCOUNT                  | 11,631,541  | 6,750,626   | (482,317)   | 540,554     |
| 專用款項<br>RESTRICTED FUNDS  |             |             |             |             |
| 學生貸款基金<br>Student Loan Funds                                    | 2,513,109   | 2,219,704   | 2,032,253   | 1,923,857   |
| 政府資助校園建設撥款<br>Government Capital Grants                         | 1,504,170   | 4,219,355   | 3,369,910   | 6,823,922   |
| 教育活動賬項<br>Educational Activities Funds                          |             |             |             |             |
| 亞洲課程部<br>International Asian Studies Programme                  | 2,336,873   | 1,698,546   | 1,272,924   | 666,368     |
| 三年制工商管理碩士課程<br>Three-Year MBA Programme                         | 7,643,835   | 7,782,188   | 7,282,551   | 7,094,678   |
| 中國語文研習所<br>Chinese Language Centre                              | 2,674,701   | 2,842,644   | 1,696,255   | 1,271,480   |
| 校外進修部<br>Extramural Studies Department                          | 25,167,365  | 17,657,581  | 13,156,154  | 7,932,658   |
| 高級行政管理文憑課程<br>Management for Executive Development<br>Programme | 799,324     | -           | -           | -           |
| 輔助業務賬項<br>Subsidiary Enterprises                                | 12,904,736  | 11,946,298  | 10,450,009  | 9,618,692   |
| 特別捐贈基金<br>Specific Endowment Funds                              | 132,328,307 | 121,262,839 | 105,691,958 | 93,300,628  |
| 研究撥款<br>Research Grants   | 37,769,853  | 27,432,057  | 18,233,384  | 14,459,155  |
| 獎學金及助學金<br>Scholarships and Bursaries                           | 198,298     | 176,600     | 156,006     | 192,066     |
| 興建建築物之捐贈及撥款<br>Building Donations and Grants                    | 25,821,913  | 24,476,265  | 51,129,224  | 49,552,106  |
| 其他專用款項<br>Other Restricted Funds                                | 15,448,764  | 8,948,614   | 8,424,937   | 10,337,909  |
| 其他專用儲備及準備金<br>Other Restricted Reserves and Provisions          | 26,382,733  | 19,446,258  | 11,813,805  | 10,501,522  |
|   | 293,493,981 | 250,108,949 | 234,709,370 | 213,675,041 |
| 資金總額<br>TOTAL FUNDS   | 331,386,035 | 295,799,984 | 246,715,269 | 232,441,492 |

## 經常費收支賬項 一九八七至一九九零年截至當年六月三十日止年度

## Income and Expenditure Accounts for the years ended 30th June, 1987 – 1990

|   | <u>1990</u><br>\$  | <u>1989</u><br>\$  | <u>1988</u><br>\$  | <u>1987</u><br>\$  |
|---|--------------------|--------------------|--------------------|--------------------|
| 收入(大學及理工教育資助委員會資助之活動)<br>INCOME FOR UPGC SUBVENTED ACTIVITIES               |                    |                    |                    |                    |
| 香港政府資助<br>Hong Kong Government Subvention                                   | 688,537,632        | 580,471,934        | 475,224,005        | 435,076,569        |
| 學費、入學申請費及畢業費等<br>Fees   | 59,085,187         | 45,909,484         | 41,714,410         | 34,921,784         |
| 租金收入<br>Rental Income   | 15,970,317         | 13,415,516         | 11,574,850         | 10,465,991         |
| 銀行利息<br>Bank Interest   | 13,096,564         | 9,697,918          | 3,852,980          | 3,607,509          |
| 雜項<br>Miscellaneous   | 602,498            | 442,454            | 467,854            | 342,625            |
|   | <u>777,292,198</u> | <u>649,937,306</u> | <u>532,834,099</u> | <u>484,414,478</u> |
| 專用款項收入<br>RESTRICTED INCOME   | <u>135,787,702</u> | <u>132,822,915</u> | <u>114,484,345</u> | <u>99,114,316</u>  |
|   | <u>913,079,900</u> | <u>782,760,221</u> | <u>647,318,444</u> | <u>583,528,794</u> |
| 支出(大學及理工教育資助委員會資助之活動)<br>EXPENDITURE FOR UPGC SUBVENTED ACTIVITIES          |                    |                    |                    |                    |
| 行政經費<br>Administration  | 59,612,268         | 48,008,003         | 45,448,683         | 40,245,855         |
| 教務經費<br>Academic Departments  | 539,569,488        | 446,748,549        | 361,277,078        | 332,520,625        |
| 校園維修<br>Maintenance of Premises   | 74,756,353         | 65,901,687         | 56,318,779         | 49,121,101         |
| 一般教育事務經費<br>General Educational Expenses                                    | 22,533,224         | 17,638,545         | 14,693,552         | 11,910,244         |
| 學生福利及康樂經費<br>Student Facilities and Amenities                               | 28,644,898         | 23,542,129         | 19,602,372         | 17,591,265         |
| 雜項開支<br>Miscellaneous Expenses  | 47,510,325         | 41,900,493         | 33,308,339         | 30,293,300         |
| 簡單工程費用<br>Minor Works   | 2,252,499          | 1,897,315          | 1,893,877          | 989,903            |
| 或然費用<br>Contingencies   | 730,845            | 631,431            | 186,502            | 521,326            |
|   | <u>775,609,900</u> | <u>646,268,152</u> | <u>532,729,182</u> | <u>483,193,619</u> |
| 專用款項支出<br>RESTRICTED EXPENDITURE  | <u>135,787,702</u> | <u>132,822,915</u> | <u>114,484,345</u> | <u>99,114,316</u>  |
|   | <u>911,397,602</u> | <u>779,091,067</u> | <u>647,213,527</u> | <u>582,307,935</u> |
| 盈餘轉大學及理工教育資助委員會撥款平衡賬<br>SURPLUS TRANSFERRED TO UPGC EQUALIZATION<br>ACCOUNT | <u>1,682,298</u>   | <u>3,669,154</u>   | <u>104,917</u>     | <u>1,220,859</u>   |



