

CHINESE UNIVERSITY BULLETIN

Spring · Summer 1996

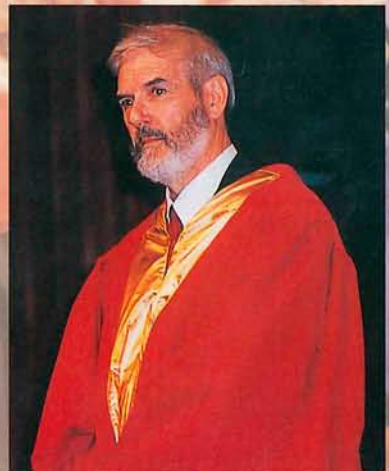
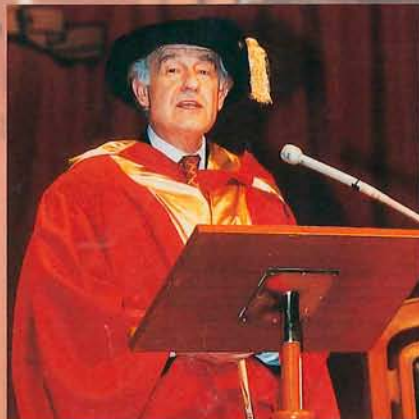

Contents

Vice-Chancellor Designate	1
<i>Prof. Arthur K.C. Li to lead the University from August 1996</i>	
The 49th Congregation for the Conferment of Higher and First Degrees	2
The 50th Congregation for the Conferment of Honorary Degrees	3
The Intercollegiate Drama Competition: Then and Now	16
The Quest for Excellence — Students' Version	18
Research Newsboard	22
<i>New Developments in the Application of Structural Equation Models</i>	23
<i>Xianggu Mushroom — How to Make it Palatable to Both the Taste Buds and the Pocket</i>	26
<i>Similarity Breeds Curability — Applying Findings on Cervical Cancer to the Diagnosis of Nasopharyngeal Carcinoma</i>	28
<i>The Why's and Wherefore's of Refraction — Laser Interactions: Light vis-à-vis Water Droplets</i>	30
Profiles	33
News in Brief	38
Gifts and Donations	49

Covers: The 50th Congregation



Chinese University Bulletin

Spring • Summer 1996



Advisory Committee on Chinese University Bulletin

Prof. Joseph M. Chan
Dr. Chiang Ying-ho
Mrs. Ho Wan Siu-wan
Prof. C.Y. Lee
Mr. Jacob Leung
Prof. Andrew Parkin
Ms. Amy Yui

Editorial Staff

Editor:
Ms. Amy K.Y. Leung
Assistant Editors:
Ms. K. Lee
Ms. Piera Chen
Mrs. Shalini B. Bahadur
Design:
Ms. May Mui
Ms. Ada Lam
Production:
Ms. Stella Lai

© The Chinese University of Hong Kong 1996

Address all correspondence to the Publication Office, CUHK, Sha Tin, N.T., Hong Kong.

VICE-CHANCELLOR DESIGNATE

Prof. Arthur K. C. Li to Lead the University from August 1996

In October 1995 the University Council announced the appointment of Prof. Arthur K. C. Li as vice-chancellor of the University with effect from 1st August 1996. He will succeed Prof. Charles K. Kao after the latter's retirement on 31st July.

A Search Committee was established in November 1994 to advise the University Council on the appointment of Prof. Kao's successor. After a worldwide search and having rigorously considered the 30 nominations and applications received, the Search Committee unanimously recommended to the University Council the appointment of Prof. Arthur K. C. Li as the next vice-chancellor of the University.

An internationally renowned surgeon, Prof. Li was born into the fourth generation of a well-established Hong Kong family. He had a classical Chinese upbringing and was educated in Hong Kong up to secondary level.

Nurtured in the spirit of service much valued by his family, Prof. Li chose to pursue a medical career and undertook the broader Natural Sciences Tripos path to medicine provided by Cambridge University. He continued his postgraduate training in England until a scholarship enabled him to work at Harvard Medical School and Massachusetts General Hospital in Boston, where he furthered his specialist training in hepatobiliary and upper gastrointestinal surgery. In 1980 he was appointed consultant at the Royal Free Hospital in London. The following year he obtained his MD degree from Cambridge.

Early in his career Prof. Li was awarded the European Society for Surgical Research Prize (1980) and the Moynihan Medal of the Association of Surgeons of Great Britain and Ireland (1982), both highly coveted awards in the field of surgery. Subsequently he was granted honorary fellowships of several surgical colleges and associations, and honorary professorships at many academic institutions. His efforts in research have led to the publication of over 200 original articles in peer review journals, numerous book chapters and abstracts.

Prof. Li joined The Chinese University in 1982 as the founding chair of surgery. He has since brought the Department of Surgery to the ranks of the most recognized surgical centres in the world.

In 1992 Prof. Li was elected by his colleagues

to take on the deanship of the Medical Faculty, which has since gone from strength to strength. New teaching departments, research centres, and specialist clinics have since been established. Members of the faculty have broken new grounds in different areas of medicine: cancer treatment, liver transplant for children, paediatric bone-marrow transplant, new reconstructive techniques in ear surgery, laparoscopic surgical techniques, and assisted-human reproduction techniques. A large number of research projects initiated by them have attracted both public funding and private donations.

Over the past 14 years, Prof. Li has made extensive contributions not only to medicine but also to teaching, research, and administration in the University. He was appointed a member of the University Council in 1983, and has served on the Senate, various key committees of the University, the Board of Trustees of United College, and its Assembly of Fellows. He has raised more than 180 million dollars for the development of both the Faculty of Medicine and the University.

Prof. Li is also active in public service. He is president of the College of Surgeons of Hong Kong and has served other medicine-related bodies, such as the Hospital Authority, the Medical Council of Hong Kong, the Hong Kong Academy of Medicine, the Hospital Governing Committee of the United Christian Hospital, and the United Christian Medical Services. He was once a member of the University and Polytechnic Grants Committee, the Education Commission, and the Technology Committee, and currently sits on a number of charitable trusts supported by very large endowment funds. Prof. Li is also a Hong Kong Affairs Adviser to China, and a member of Hong Kong Special Administration Region Preparatory Committee. □



The 49th Congregation for the Conferment of Higher and First Degrees

The 49th congregation for the conferment of higher and first degrees was held on 7th December 1995 at the University Mall. Sir Yuet-keung Kan, pro-chancellor of the University, officiated at the ceremony which was attended by over 7,000 guests, parents and graduates.

Higher Degrees Awarded

MD	4
Ph.D	36
M.Phil.	234
MA	22
M.Div.	7
MFA	2
M.Mus.	3
MBA	123
M.Ed.	44
M.Sc.	4
MSW	6
Total	485

First Degrees Awarded

BA	424
BBA	435
B.Ed.	72
B.Eng.	195
M.B. Ch.B.	134
B.Med.Sc.	4
B.Nurs.	68
B.Pharm.	31
B.Sc.	530
B.S.Sc.	590
Total	2,483

A total of 2,968 degrees were awarded this year. Among the 485 higher degree recipients were the first two graduates of the Master of Fine Arts programme, the first 34 graduates of the Executive MBA programme, and the first five graduates of the Master of Philosophy programme in nursing. The

first degree graduating class was marked by the first batch of 31 'home-grown' pharmacy graduates of the B.Pharm. programme and the first 56 undergraduates who were able to complete their studies at the end of the first semester, thanks to the implementation of the flexible credit unit system.

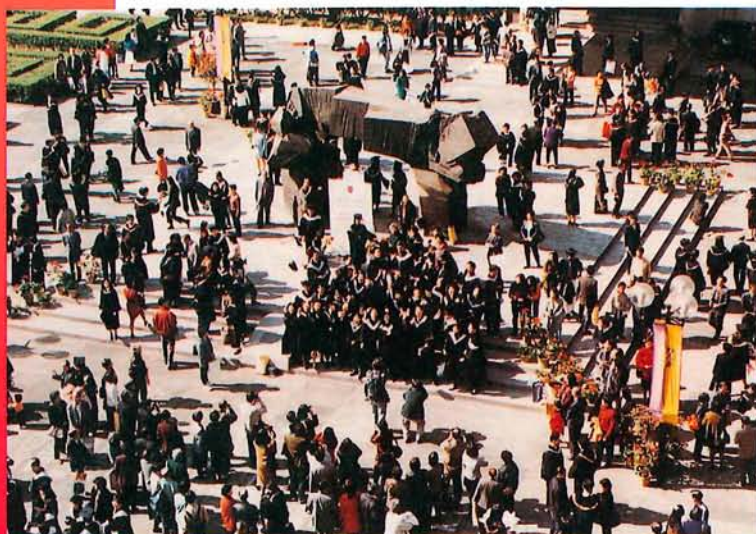
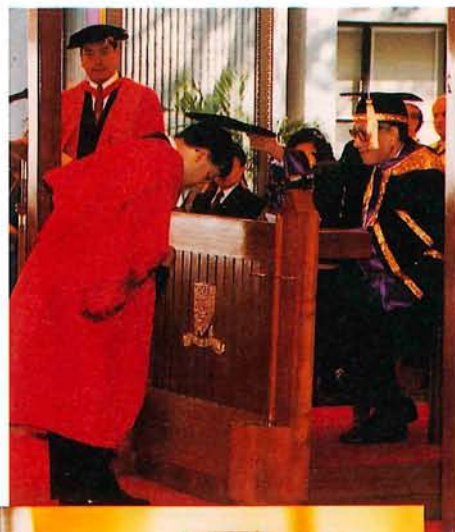

Prof. Charles K. Kao, vice-chancellor of the University, made an address on the importance of non-academic education for a young person. According to Prof. Kao, a university education should not only impart professional and academic knowledge but should also develop a sense of social justice and righteousness in its students. He emphasized that while he respects those who assert their right to the freedom of speech, they should let reason and restraint guide their actions, for it is only by so doing that they can command true respect and support from society. □

The 50th Congregation for the Conferment of Honorary Degrees



From left: Prof. Charles K. Kao, Mr. Thomas Chen Tseng Tao, Lord Wilson of Tillyorn, the Rt. Hon. Christopher Patten, Prof. Jonathan D. Spence, Mr. Tang Hsiang Chien, and Sir Quo-wei Lee

The 50th congregation for the conferment of honorary degrees was held on 18th January 1996 at the Sir Run Run Shaw Hall. HE the Governor and Chancellor of the University, the Rt. Hon. Christopher Patten, officiated at the ceremony and conferred honorary degrees on four distinguished persons.



Prof. Serena Jin

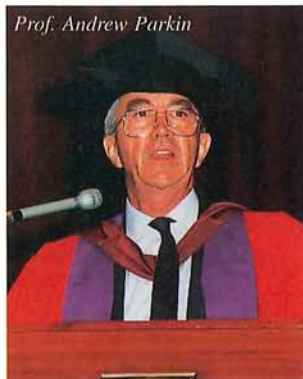

Prof. Andrew Parkin

The degree of Doctor of Laws, *honoris causa*, was conferred on Lord Wilson of Tillyorn; the degree of Doctor of Literature, *honoris causa*, on Prof. Jonathan D. Spence; and the degree of Doctor of Social Science, *honoris causa*, on Mr. Tang Hsiang Chien and Mr. Thomas Chen Tseng Tao. Their citations were

written and delivered by Prof. Andrew Parkin of the Department of English, and Prof. Serena Jin of the Department of Translation. Lord Wilson addressed the audience on behalf of the honorary graduates, the topic of his speech being 'Hong Kong: Aspects of the Future'. □

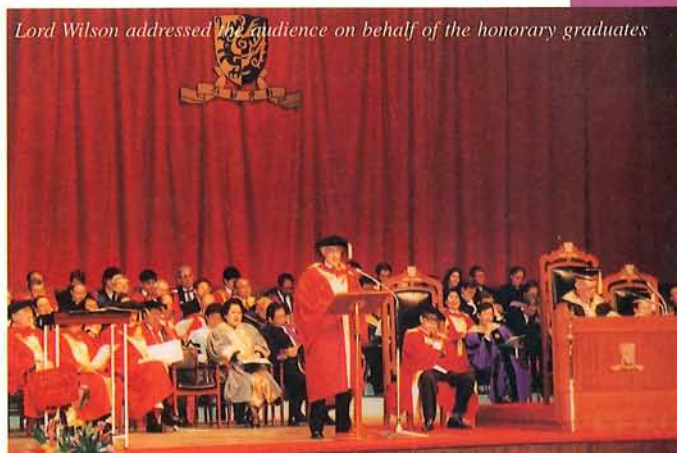

Lord Wilson addressed the audience on behalf of the honorary graduates

A Citation



Lord Wilson of Tillyorn GCMG

The descent to Kai Tak on a clear night reveals displays, like jewellery, of growth and prosperity scintillating for all to see through the good offices of China Light and Power.

It is entirely possible that Lord Wilson, in his present capacity as chairman of the power company that serves an area a quarter the size of the United Kingdom and stretching from the Clyde estuary to the Western Isles of Scotland, has similar plans for the northern part of the Scottish night sky. If so the neon signs would doubtless be in English, Chinese, and Scots Gaelic. Another of his current jobs is to chair the Scottish Committee of the British Council. He is also the Chancellor's Assessor of the Court of the University of Aberdeen, which means he is the senior lay member of the university's governing body.

Our honorand's previous activities in Hong Kong's seat of power during five difficult years of crisis were in no small measure responsible for maintaining the well-being and prosperity of the territory, for he is certainly one of those who have laboured to make a small, unremarkable trading post into one of the world's great cities.

The winding trail from youthful obscurity to the privileges and difficulties of running

Hong Kong is a remarkable one. Born at Alloa, Scotland, on St. Valentine's day in the mid-1930s, David Clive Wilson attended Trinity College, Glenalmond, then won a scholarship in history to Keble College, Oxford. Before Oxford, though, he served as an officer in the Black Watch, otherwise known as 'the ladies from hell' because soldiers of this regiment wore kilts in the trenches in the Great War, 1914–1918. After Oxford, yet another kind of education followed when in 1958 he joined the Foreign Office.

In 1960 another surprise on the trail: two years of Chinese language study at Hong Kong University, where he emerged as one of Prof. Ma Meng's very brightest students. His next posting was Beijing in 1963 at roughly the same time that our university was born. Many Hong Kong links had been made and the first steps taken on the unforeseen trail that led to Lord Wilson's gracious acceptance of the invitation to be here today.

After two years in Beijing, he returned to the Foreign Office, Far East Department. Then academia beckoned, he resigned from the diplomatic service, and became executive editor of *The China Quarterly* in London University's Contemporary China Institute at the School of Oriental and African Studies. In 1973, he obtained a London Ph.D. for his work on British relations with the Kuomintang in the 1920s. During these years he had met D.C. Lau,



then professor of Chinese at SOAS, later dean of arts, and now honorary professor of the Institute of Chinese Studies at The Chinese University.

A fluent speaker and reader of Chinese, with an enduring interest in contemporary China and Chinese culture, Dr. Wilson was now hiking steadily towards a distinguished academic career. Unexpectedly, he changed course again in 1974, rejoining the diplomatic service, a rare feat. Three years later he was back here as political adviser to the Hong Kong Government. After testing his mountaineering mettle as a member of the British expedition to Mount Kongur in China, he returned to the Foreign and Commonwealth Office. When he was just 49, he found himself participating in the negotiations over the future of Hong Kong and acting as senior representative for Britain on the Sino-British Joint Liaison Group.

He became a Knight Commander of the Order of St. Michael and St. George in January 1987. On 9th April he returned, taking up his duties here as Governor and Commander-in-Chief of Hong Kong. As a diplomat, he did not expect to be given this job. In theory the governor has enormous power; in practice power is used sparingly. Lord Wilson looks back on it all as the most fascinating job one could ever do. Among his most dramatic and testing moments must certainly have been that period of anguish and doubt unleashed by the events in Tiananmen Square, after which he had to rebuild the territory's confidence.

In January 1991 he was made Knight Grand Cross of his order, and the following year, he was the first governor to be made a life peer while still in office, taking the title Lord Wilson of Tillyorn. His choice of title acknowledges the place where he has a cottage and also his enduring love of fantastic landscapes, perhaps gained as a young man when he led an expedition to Mount Roraima, the model for Conan Doyle's book, *The Lost World*.

As student of contemporary China and diplomat, Lord Wilson became one of Britain's best China experts, contributing significantly to the negotiations on the future of Hong Kong

and the signing of the Sino-British Joint Declaration in 1984. As governor, he had to keep three plates spinning on the end of bamboo poles: British, Hong Kong, and mainland Chinese dishes, with sometimes contrasting ingredients and of conflicting culinary interest. Despite inevitable wobbling, he maintained stability — a key factor in our prosperity here, launching farsighted and far-reaching changes such as the new airport project, more consultation and increased numbers of elected seats in the legislature, improved highways, sewage treatment, care for the quality of the environment, and the very rapid expansion of tertiary education. We in the University strive to rise to the challenges he has set us.

As Chancellor of the University, Lord Wilson always encouraged our quest for excellence through teaching, research, and many international links. During his term we acquired the famed research magnet for contemporary Chinese studies, the Universities Service Centre, and we established the Hong Kong Institute of Biotechnology. He also helped foster our close and highly valued association with Yale University.

No account of him should omit the Wilson Trail from historic Stanley Gap to the beautiful Pat Sin Range, a symbol now of his affection for Hong Kong and its people, where, I am told, he would outpace even his bodyguards. On these cloudy peaks it is not too fanciful to see the Scottish landscape imaged fleetingly in Nature's mirror.

Mr. Chancellor, this is the last occasion in Hong Kong's history that a British governor may confer on his predecessor an honorary degree. Lord Wilson is a man whose background as a diplomat and whose great knowledge of Chinese people and contemporary China helped him to keep the three plates spinning. That very demanding balancing act did not always make him popular, but he managed it without sacrificing his personal integrity in public service. It is my singular and happy duty to present David Clive Wilson for the degree of Doctor of Laws, *honoris causa*. □

A Citation

Prof. Jonathan Dermot Spence Ph.D., LHD, Litt.D.

There is an affinity between history and law, for both depend on scrupulous research into matters of fact and evidence. Good lawyers, though, uncover not only the letter but the spirit of the law. Similarly, good historians must present the evidence in a narrative that strikes us as significant and true, faithful to the life and spirit of the people and their times. Prof. Spence is such an historian.

There is also an affinity between history and epic, because they both deal with leaders, even heroes, who have lived and died as agents and victims of the great events of their times. The early epic poets were also historians of war and warriors, of great lovers, of nationhood, of religion, of legend, and of myth. In the eighteenth century, some English writers, the novelist Fielding and the historian Gibbon are the great examples, began to publish epics in prose rather than verse. While every good epic, whether in verse or prose, is some kind of history, not every good history can be an epic. Jonathan Spence's *The Search for Modern China* is a history book that is also an epic in prose. It is history that sifts the past to find cultural as well as political change, history that

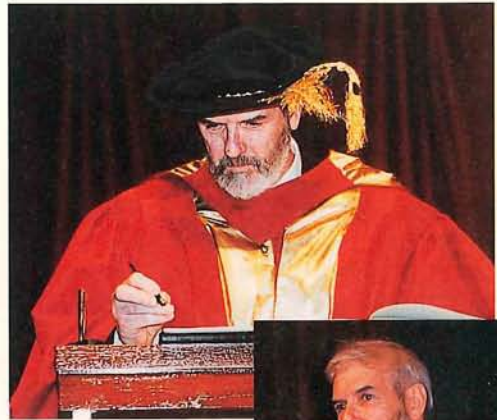

sets the past to uncover the present, history raised through the brilliance of its writing to the condition of literature.

Born in Surrey, England in 1936, Jonathan Spence read history at Clare College, Cambridge from 1956 to 1959, before going to Yale for his MA and Ph.D. degrees. In 1965 he was appointed as an assistant professor of history at Yale, achieving the full professor rank a mere six years later. In 1976 he was given the George Burton Adams Chair of History at Yale and in 1993 was made Sterling Professor of History there. His academic awards are many: in 1978 he won the William C. DeVane Medal, he has been both a Guggenheim and MacArthur Fellow, he was awarded the Los Angeles Times History Prize in 1982 and the Vursel Prize of the American Academy and Institute of Arts and Letters the following year. In 1987 he was visiting professor at Peking University. From American institutions, he holds three honorary degrees.

His teaching has not made him neglect



research, his research has not absorbed him so much as to prevent his writing, his writing has not been such as to prevent its publication: on the contrary his publications have been very successful both with professional historians and the public at large. The simple but significant dedication of his epic *The Search for Modern China* is 'For My Students', a dedication that suggests the author's real care for his students, demonstrating that teacher, researcher, and writer are at their best one living being, who combines all three activities, so that they feed and enrich one another. Jonathan Spence embodies another truth — that those who write well care; they write, *because they care*.

His other publications include almost a dozen significant books, such as *Chinese Roundabout: Essays in History and Culture* (1992), some of his own favourites, *The Death of Woman Wang* (1978), *The Gate of Heavenly Peace* (1981), *The Memory Palace of Matteo Ricci* (1984), *The Question of Hu* (1988), and then his studies of foreign attempts to influence China, *To Change China: Western Advisors in China Sixteen Twenty to Nineteen Sixty* (1969).

These publications and all the others I cannot mention here, Mr. Chancellor, have not prevented Prof. Spence from shouldering the burden of administration: he has been chairman of his department and director of the Division of Humanities at Yale. He has been a leader in the development of graduate studies in history and of East Asian studies at Yale. At the national and international levels he has served as director of the National Endowment for the Humanities Seminars and has vigorously promoted Sino-US academic exchange. In 1993 he was named honorary professor at the University of Nanjing.

His association with The Chinese University of Hong Kong is very natural in a Yale alumnus and teacher, for our links with Yale are strong. It is also logical in one who values China and Chinese culture. Furthermore, in 1992 Prof. Spence delivered a series of public lectures in our university as the Distinguished Visiting Scholar of United College. I remember them with pleasure and also a seminar he gave in the History Department on that occasion. He spoke in such a way as to awaken curiosity in his audience so that they wished to find out more. That is the essence of good teaching.

In *The Outline of History*, H.G. Wells pointed out that 'Our true nationality is mankind.' In taking modern Chinese history as his field, Prof. Spence has chosen to tell the recent story of at least one quarter of mankind. That an Englishman who is also American has succeeded so triumphantly, in the opinion of many learned Chinese readers, in this epic task of understanding another country, another culture, the one with the deepest sediment of the past, is indeed remarkable. It suggests, too, he has obtained this Wellsian, truly human nationality, the one nationality that really matters.

Jonathan Spence is a writer who makes history not just an academic exercise but something enticingly readable. Like all the best historians, he is essential reading for those who wish to understand human beings and their actions. Histories, we are told, begin in the hearts of men and women. If we read them carefully, they can make us wise. I count it my special privilege, Mr. Chancellor, to present to you a man with many friends among us, Prof. Jonathan Dermot Spence, for the degree of Doctor of Literature, *honoris causa*. □

A Citation

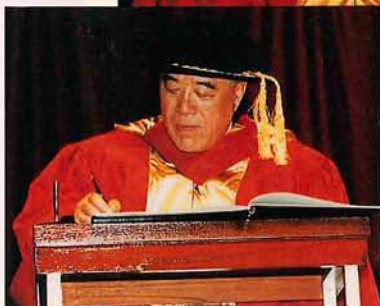
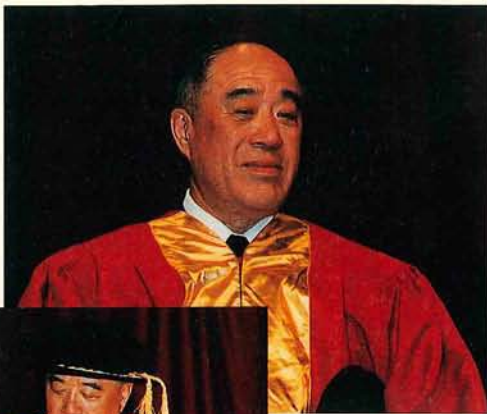

Mr. Tang Hsiang Chien OBE, JP

A prominent Hong Kong industrialist, Mr. Tang Hsiang Chien, born in Shanghai in 1923, is a third-generation textile magnate of a well-established and distinguished family, which has its ancestral home in Wuxi of Jiangsu Province. Family upbringing has encouraged Hsiang Chien since childhood to be forthright and persistent, qualities which remain very much part of his character. A very diligent student who thrived on learning, young Hsiang Chien was among the top students in every examination.

In 1948, Tang Hsiang Chien pursued the study of economics in the United States, obtaining a master's degree from the University of Illinois in 1950. Following in the footsteps of his father and grandfather, he then established Soco Textiles (Hong Kong) Ltd. in Hong Kong. In the early 1950s Hong Kong lacked raw materials, labour, manufacturing facilities and markets for its products, all of which are essential for the successful development of any industry. Despite working in such unfavourable conditions, Tang strove ahead indefatigably, overcoming adversity and making the best of difficult situations. His perseverance paid off and the textile industry headed towards new and brighter horizons.

When setting up a business, Tang Hsiang Chien carefully supervised all tasks, big and small, from site development and building construction to advertising and promotion. In his textile manufacturing he was devoted to the immaculate planning and design of every detail in spinning,

weaving, dyeing and even the production of garments. Only when the business was well on track would this 'field marshal' hand over its well-organized management to his young and able 'attachés', so that he would be free to start another new plant from scratch. Following this pattern over several decades, Mr. Tang has established dozens of manufacturing plants not just in Hong Kong, but also north and south of the Yangtze, in the remote northwestern part of China, and in other parts of the world.

A firm believer in 'No pain, no gain', Mr. Tang, who has been an industrialist all his life, never speculates. His accomplishment in breaking new ground and achieving such spectacular success in the textile industry owes much to two factors. The first is his constant search for innovative ideas in various fields, the other is having the courage to set up business in different regions worldwide.

In 1973, the government of the sugar-exporting Mauritius began to develop its country's other industries. Acting on his impeccable business instinct, the farsighted Tang Hsiang Chien travelled all the way to Africa to establish a factory there, thus pioneering for other Chinese manufacturers who were to follow his example. In the late seventies, not long after the Cultural Revolution, Tang set about establishing his businesses in the Pearl River Delta, Shenzhen, Shanghai, and Wuxi as soon as China opened its markets. In 1979 he visited Xinjiang. There he set up a factory in 1980, starting production in September that same year!

The first industrial joint venture in Xinjiang,



Tian Shan Wooltex Ltd. is one of Mr. Tang's investments. The business got off to a rough start owing to its remote location and a general lack of efficiency. Undaunted, the ever practical and efficient Tang Hsiang Chien tackled an overhaul of the management system, developed international markets, and set about continually improving the quality of the plant's products. Excellent results were achieved within a short time. After over a decade of hard work, Tian Shan Wooltex Ltd. is among the best performing industrial joint ventures in China and has four times been named as one of China's top 10 joint ventures. In the book *Journey to Xinjiang*, there appears a couplet by Mr. Tang:

*The vast land Northwest is always in my mind,
Xinjiang's growth is ever in my heart.*

This reflects explicitly Mr. Tang's lofty aspirations in developing new zones. An industrial empire has indeed been built on the boundless prairie at the foot of Tian Shan.

Mr. Tang has continued to forge ahead, unperturbed by the fact that many of his dreams have already been realized. In the late eighties, realizing that the electronics industry would have a bright future here, he started the mega-firm, Meadville Ltd. Even now, Mr. Tang is up at dawn and does not rest until midnight, giving his best as always. That his spirit strives ever forward, reaching out for new ideas, is certainly proven by Meadville's exceptional performance.

As chairman of Soco Knitters (Hong Kong) Ltd., and a director of various companies such as Uni-Shanghai Wooltex Ltd., the Xinjiang Tian Shan Wooltex Ltd. and Meadville Ltd., Mr. Tang is very heavily engaged in the world of business and industry. He has still managed though to give time to public service, for he chaired the Federation of Hong Kong Industries. He has also served as chairman of the Hong Kong Cotton Spinners Association and as a member of the Hong Kong Trade Development Council, a member of the Vocational Training Council, a member of the Industry Advisory Board, and a member of the Industrial Development Board. His concern for health issues is manifested in his work as director of the Tung Wah Group of Hospitals and director of the Yan Chai Hospital. He was also an executive member of the Basic Law Consultative

Committee. He is currently the honorary president of the Federation of Hong Kong Industries. In our own university, he is at once chairman of the New Asia College Board of Trustees, a member of the United College Board of Trustees and until last April, a member of the University Council. As chairman of the Hong Kong and Shanghai Economic Development Association, he is also a member of the Standing Committee of the Chinese People's Political Consultative Conference, a Hong Kong Affairs Adviser and a member of the Preparatory Committee for Special Administrative Region appointed by the Chinese Government.

Mr. Tang is an ardent promoter of education and has generously supported various academic activities. He has established the Tang's Education Fund, sponsored our own New Asia College's commemoration of the Dr. Ch'ien Mu centenary, helped to establish the United Library of Shanghai University, and assisted with funding for the students and teaching staff there and in Xinjiang University to participate in academic exchange programmes with the universities in Hong Kong. Adept at reading people and putting his staff's abilities to the best use, Mr. Tang appreciates the fact that aside from equipment and raw materials, skilled and talented staff are essential for business success. He believes that education is fundamental to the development of talented people. Mr. Tang's firm goal in life is to promote education and contribute to the building of a strong China with the gains from industrial success.

Mr. Chancellor, as the preeminent magnate of Hong Kong's textile and electronic industries and as a distinguished philanthropist, Tang Hsian Chien has been a model of assiduity for Hong Kong's industrialists in the past few decades. Mr. Tang's beneficiaries include even the people of remote Xinjiang where life has improved through his development there. His contribution to prosperity and education deserves our deepest respect and recognition. Accordingly, in 1982, Mr. Tang was appointed Justice of the Peace, and in 1983 he was made an Officer of the Most Excellent Order of the British Empire. It is now the turn of this university to honour him, Mr. Chancellor, for his outstanding achievements and momentous contribution to our society and its universities. It is my pleasure and honour to present Mr. Tang Hsiang Chien for the award of the degree of Doctor of Social Science, *honoris causa*. □

A Citation



Mr. Thomas Chen Tseng Tao CBE

Mr. Thomas Chen Tseng Tao is a well-known entrepreneur and leading property developer in Hong Kong. Though his family comes from Shunde, Guangdong Province, Mr. Chen was born in Hong Kong and received his primary and secondary education here. During the Japanese occupation he moved to the mainland and read banking at Fudan University, situated at that time in Beibei, Sichuan, a centre well-known to scholars and academics. Graduating in 1946, Mr. Chen travelled to Shanghai before returning to Hong Kong where, in 1952, he went into the construction business which led later to work in Borneo. He returned to Hong Kong in the 1960s and began his career in property development.

Today, although Hong Kong has a thriving and stable economy, a small change will affect the whole community. As most businesses rely very much on the driving force from property development, prosperity in that market has a profound overall effect. Yet, if we look back for a moment, we can see that despite its immense influence, property development has a brief history here of about 30 years. There were only a handful of companies until the early

sixties, when the major companies of today emerged: among them, Mr. Chen's Hang Lung Development Company Limited plays a leading role.

In Borneo, Mr. Chen acquired extensive experience in architecture as well as construction itself. After returning to Hong Kong Mr. Chen was determined to improve the quality and design of buildings here. He joined his elder brother Mr. T.H. Chen, and together, with total commitment to effective strategy and management, characterized by their prudent and pragmatic style, the brothers raised property development to a completely new level. Mr. Chen's vision and knowledge equip him to perceive the opportunities that promote and advance his business, helping him to maintain his leadership.

When his brother passed away in 1986, Chen Tseng Tao became managing director and chairman of the group. Over the years, the Hong Kong Government through its own initiatives, such as its public housing policy, has encouraged complementary activities in property development. All major property developers have thus cooperated with the government to provide many types of housing for the community, catering to their growing desire for pleasant, quality homes. Under the



leadership of Mr. Chen, Hang Lung Development has rapidly expanded, gaining an enviable reputation in this field.

Mr. Chen feels that the basis for his success is a continual process of learning and innovation. The company's buildings can be found all over Hong Kong. Characteristically, the buildings are multifunctional, creating spaces for varied commercial facilities such as restaurants, hotels, and shops. These towering skyscrapers are Mr. Chen's trees. They sprout and grow, needing the constant attention of their 'gardeners' to help them flourish. Mr. Chen's quiet devotion and hard work, in his special garden, have made an outstanding contribution to the growth and prosperity of Hong Kong's businesses and the economy as a whole.

Although Mr. Chen enjoys distinguished achievements in his business, he takes a keen interest in serving the community in other ways. He is a modest and unassuming man who likens himself to liquorice root, known for its gentle medicinal qualities. There is a Chinese saying, 'It's cold, living in jade palaces.' Successful people in high positions can be just lonely. Mr. Chen is an exception. Fame and fortune, he feels, are but a part of his life. What he values most is the kindness of his many acquaintances. The real glory is a gift for friendship. Mr. Chen also appreciates the arts and through his reading has found a particular interest in modern Chinese history. His life is thus a very full and happy one, not least because of his service to the community. As vice-president to the Real Estate Developers Association of Hong Kong, a member of the Land and Building Advisory Committee, a member of the Land Development Corporation, and a member of the Provisional Airport Authority, he contributes his expertise in the area of property development, urban renewal, and the planning of the new airport. Mr. Chen also served as a member of the Hong Kong Stock Exchange and

non-executive director of the Securities and Futures Commission. As chairman of the Hong Kong Securities Clearing Company Limited, in 1993-94 he made great efforts to promote a new central clearing system to provide transparency and confidence in the operation of the Hong Kong Stock Exchange. Since then the financial sector has flourished and Hong Kong has become justly recognized as an international financial centre. His contributions to the financial sector are thus truly distinguished.

Mr. Chen has been a director of the Hang Lung Development Company Limited. He was also a member of the Basic Law Consultative Committee. His keen support of higher education dates back a long time. He became a member of the Board of Trustees of the United College in 1991. He is also a member of the Court of the Hong Kong University of Science and Technology. In 1993, Mr. Chen donated HK\$10 million to the Hong Kong Cancer Institute of The Chinese University as a development fund towards specialized treatment and research facilities. Mr. Chen's generosity has already helped many patients. All these activities deserve our respect and acknowledgment.

Mr. Chancellor, through his vision and knowledge, Mr. Thomas Chen has brought together the right human qualities in himself and his associates in the right place and at the right time to gain exceptional success and notable achievements in property development and the financial sector. Mr. Chen was made a Commander of the Most Excellent Order of the British Empire in 1993. Because of his remarkable contributions and generous support for the universities and the community-at-large, Mr. Chancellor, it is with great pleasure that I present Thomas Chen Tseng Tao for the award of the degree of Doctor of Social Science, *honoris causa*. □

Hong Kong: Aspects of the Future

An Address by Lord Wilson of Tillyorn

Chancellor, Vice-Chancellor, fellow members of the University, ladies and gentlemen:

I cannot tell you what a tremendous pleasure it is to be back in Hong Kong amongst so many old friends and familiar places. So much of my life has been bound up with Hong Kong in one way or another, either here or involved with its affairs. Every time I have returned, however short the absence, it is a great thrill to see from the aircraft the islands, and then the densely crowded tip of Kowloon, coming into sight. It is an even greater thrill to feel again the bustle and energy of this remarkable place. How much more so after an absence of three and a half years.

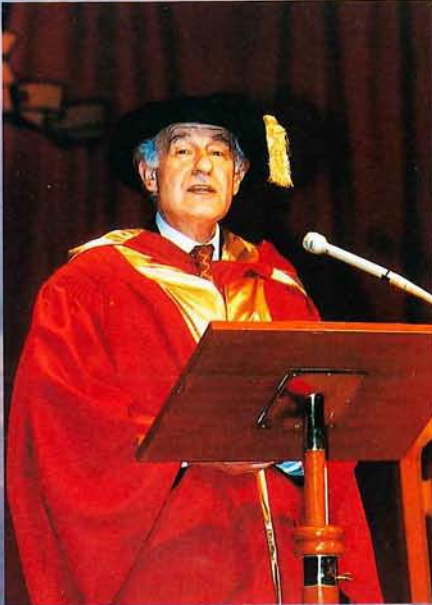

Life is full of the unexpected. Nobody can predict accurately what will happen to themselves during their lifetime. No community knows for certain what will happen from one generation to another. People seize opportunities as they come. Communities — successful communities — do the same with the opportunities and have the resilience to weather the storms.

Many years ago I was a student on the other side of the harbour at one of Hong Kong's other great universities, the University of Hong Kong. I never dreamed then that one day I would have the great honour and pleasure to be at a ceremony like the one today. Indeed, so long ago was it that this university, in its highly successful united form, did not yet exist. But then I never imagined either that I would find myself doing many of the other things that have occurred between those years and now, let alone having for a time the immense privilege and responsibility of being governor of this unique and remarkable territory.

This personal link between Hong Kong's two oldest universities is, I feel, symbolic. Symbolic of the cooperation that increasingly exists between all of Hong Kong's growing number of universities and institutions of higher education — a cooperation that must be strengthened if all those institutions are to play the role they should in the education of Hong Kong's young people and therefore in the future of Hong Kong in its broadest sense.



It is an equal honour and pleasure to find myself in the company of three such distinguished fellow honorary graduates — Mr. Thomas Chen Tseng Tao, Prof. Jonathan Spence and Mr. Tang Hsiang Chien.

The honouring together of these three distinguished persons is surely symbolic also. What do they represent? Two very successful, public spirited, Hong Kong businessmen (one of whom established one of the early joint ventures in China) and a very distinguished expert on China's history who has an ability to bring excitement to the study of the past which is the mark of the truly great historian.

Why symbolic? Here are two of the pillars which sustain this community — knowledge as one pillar and the creation and public-spirited use of wealth as the other. What's more, all three of these distinguished new honorary graduates — perhaps I could say all four of us — have the common thread of involvement in varying forms with China as well as Hong Kong.

We, as honorary graduates, are very much the older generation. It is a great pleasure for us to become part of the University in this way — and to do so without taking exams! But universities exist for training generations much younger than ours; and those who will be graduating from The Chinese University of Hong Kong — and doing so after some pretty strenuous exams — are this year a particularly important and precious generation. They will be starting their careers as Hong Kong once again changes its appearance, outwardly at least, and becomes a Special Administrative Region of the People's Republic of China.

I have watched with keen admiration how our universities and colleges have coped with the massive programme of expansion which the government has called for over the past several years and which has been continued, Chancellor, under your leadership. Hong Kong needs those well-educated students to be its leaders in every area of society over the next decades. They have a momentous and fascinating task ahead of them.

What can one say to those whose careers will be starting in the new Hong Kong? Perhaps Prof. Jonathan Spence can help. He talks about the excitement of learning. He called the most recent I have seen of his splendidly readable books *Chinese Roundabout*. Why? Because he liked the sense of 'carousel'. It conjures up, he says, an image of children — 'those scholars of the future, knees gripping the painted wood, hands holding on for dear life, heads thrown back with laughter in the vertiginous wind.'

There is an excitement in learning — and a sense of never knowing where all that learning will take you, just as we never know where our own lives will lead us. The community knows that we need these scholars, even though the community doesn't know, and never can know, what those scholars will do in the future; where the leaders of the future will lead; what new issues they will face; nor how they will face them. We only know that we need people with knowledge, wisdom, and a commitment to serve the community that gave them their own chance in life.

Perhaps the experience of those like our two business leaders honoured here today can help to show how our younger generation should tackle its own future. For years, since the end of the Second World War at least, the Hong Kong community and its business leaders have been adept at facing realities, often uncomfortable realities. They have made them into advantages where others would have seen only problems. The UN embargo on trade with China; threats of protectionism in the Western world; transformation from manufacturing to a service economy; the need for massive investment in Hong Kong's own infrastructure; uncertainty about the future after 1997; all have been faced and dealt with vigorously and successfully.

That uncertainty about the future cannot be expected to vanish or fade away. There are no precedents for the way in which sovereignty and administrative authority in Hong Kong will change in 18 months' time. There are no precedents for the detailed arrangements set out in the

Joint Declaration, nor the length of the transition to the full implementation of those arrangements 13 years after they were agreed. Those of us for whom the Joint Declaration seems like yesterday have to remember that most students of this university had barely started primary school when it was signed. They will come fresh to the framework that will shape their lives.

Like Hong Kong's generations of leaders before them, they will face new, and sometimes difficult, realities. They will surely do so in a way which is as pragmatic and positive as those who went before.

How do we all face these new and sometimes troubling realities? Let me turn again to Prof. Spence for help. He warns against the danger of stereotypes. In his own work he has done an immense amount to break away from stereotyped images of China's past. Instead he has introduced us to real people facing real problems, whether they be emperors or brigands. There surely is the road for the practical scholar and for those who will deal successfully with unfamiliar people or unfamiliar ways of doing things.

Hong Kong's future lies in China. We all know that. But as a special part of China — different from and complementary to the rest. We all know that too: it is the thread that runs through the Joint Declaration. We know that to make this future successful and beneficial for both Hong Kong and China requires tremendous effort on both sides up to, through and beyond 1997.

A notable scholar of Central Asia once said that those who live on the periphery of great states know more about the way those states operate, and their culture, than those within ever know about the people on their borders. That, he said, is how those smaller communities manage to survive.

There is an obvious lesson here for a smaller community like Hong Kong. But, if the big states are to benefit fully from what those smaller communities can often bring to them, then they too have to spend some effort understanding their special characteristics.

In the past it has not always been easy to persuade people in Britain to understand the special characteristics of Hong Kong. But, over the years, it has gradually been learned that Hong Kong flourishes best, to everybody's advantage, when it manages as much as possible of its own affairs. That is why the practical way in which Hong Kong has operated is often so different from what is laid down in the old constitutional documents. It is that practical experience — that high degree of autonomy in all except foreign affairs and defence — which China has set out in the Joint Declaration as its policy for Hong Kong after 1997 and which people in China will need to carry out in practice if Hong Kong is to flourish to the benefit of the rest of China as well as the people of Hong Kong itself.

So making a success of the future of Hong Kong requires knowledge and understanding — from both sides. It requires persistent contact and dialogue — on both sides. And it demands the avoidance of the easy stereotype — on both sides.

That is where the lives and work of my fellow honorary graduates today point the way. A deep study of China and its history. Enterprise successfully applied both in Hong Kong and in mainland China. And a sense of community service to cap it all. The Council of the University in its wisdom has given some good models for this generation of students to follow.

May this all-important generation of students at this great university become the successful leaders of Hong Kong's tomorrow.

May this university, together with Hong Kong's other universities and colleges, continue to act as a centre of learning and wisdom in the years ahead.

And may Hong Kong move forward with courage and see its future blessed with the prosperity which will allow all its people to flourish. □

The Intercollegiate Drama Competition: Then and Now

In November 1995, the drama societies of the University's four constituent colleges held their annual drama competition on campus. The productions were of an equally high standard and each college managed to clinch a prize.

Under Hong Kong's primary and secondary education system, the average student has minimal exposure to drama. For many students at the University, the intercollegiate drama competition is their initiation into the world of the theatrical arts, offering them experiences that they otherwise would not have had.

What follows is a brief history of this competition.

'In the Wake of the Wind', winner of Outstanding Original Script

A Long Tradition

In the 1960s, drama societies from different tertiary institutions and colleges of education would take part in an annual competition organized by the Hong Kong Federation of Students. The Chinese University's representatives were the drama societies of its three constituent colleges, Chung Chi, New Asia and United, who competed against each other as well as their counterparts from other institutions. At the time, the event was the highlight of the year: competition was keen and the standard was very high.

In the 1970s, the drama societies of the three colleges coalesced to form the Chinese University Student Union Drama Society (CUSUDS). It began to organize intercollegiate drama competitions for its three members.

Sir Run Run Shaw Hall's Involvement

The enthusiasm for these events seemed to have waned in the early eighties. It was not

until Sir Run Run Shaw Hall was established and took over as organizer that interest was revived. Sir Run Run Shaw Hall invited the participation of the dean of students' offices in the colleges, organized an intercollegiate drama competition in October 1984, and assisted the CUSUDS to stage a performance in March of the following year. Both have since become annual events at the University: the competition would take place in the first semester as a warm-up and to tap potentials, then the annual performance staged by CUSUDS would take place in the second semester to foster cooperation among the three colleges.

By the mid-eighties, drama had regained, if not surpassed, its former standing on campus. The years between 1986 and 1988 were the golden age of student theatre at the University. Between the intercollegiate competition and the CUSUDS annual performance, each college would present its

own production. An extra spurt of life was provided in the autumn of 1988 with the birth of the Shaw College Drama Society, which followed the founding of Shaw College. To allow the society to orient itself, the competition was suspended for a year. It resumed with new vigour in 1989 and involved four colleges for the first time. Sir Run Run Shaw Hall has since cooperated with the four drama societies to organize the competition on an annual basis, with sponsorship from the dean of students' offices in the colleges.

Impact Beyond the College Gate

Over the past 15 years, Chinese University graduates have pervaded the ranks of the professional stage, the mass media, art administration, and advertising. Their performance in Hong Kong amateur theatre has moreover been highly commendable: Long, Fung and Partners and the New Asia Drama Club, formed by alumni of the New Asia Drama Society, received awards for best performance and outstanding overall performance in the 1995 Urban Council

Drama Competition; Dramaholics, formed in November 1995 by alumni of the United College Drama Society, put on a fund-raising performance in Sir Run Run Shaw Hall; and Nonsense Maker, whose members are drawn from the University's graduates, completed its 13th production in December 1995 at the Cultural Centre with support from the Arts Development Council.

Some of the most well-known figures in the dramatic arts in Hong Kong today were active participants in intercollegiate and intervarsity drama back in the sixties. For them and for others, the intercollegiate drama competition has been more than another item under the worn-out term 'extracurricular activity': it has been the starting point of a career, and a means to enjoy and transcend everyday life. □

Members of the Chung Chi College Drama Society



Results of the 1995 Intercollegiate Drama Competition

Best Performance

Awardee New Asia College Drama Society
Piece Farewell Evening

Outstanding Director

Awardee Nickal Ho and Janet Lok, New Asia College Drama Society
Piece Farewell Evening

Outstanding Actor/Actress

Awardees 1 Li Yuk Ki, New Asia College Drama Society, as Monica
2 Carol Liu, Shaw College Drama Society, as Ah Fei
3 Ng Ying Cheung, United College Drama Society, as Ah Chung

Outstanding Stage Effects

Awardee Chung Chi College Drama Society
Piece Enigma II

Outstanding Original Script

Awardee Shadow Lung, Shaw College Drama Society
Piece In the Wake of the Wind

Backstage Heroes

Awardee United College Drama Society
Piece Spring Snow



Carol Liu, winner of Outstanding Actor/Actress Prize

The Quest for Excellence

— Students' Version

Prestigious Rhodes Scholarship Goes to CUHK Student

Jack Wong Chak-kei, final-year engineering student majoring in electronic engineering, has been chosen as the Hong Kong Rhodes Scholar-elect for 1996. He expects to further his studies in control engineering at Oxford University for two years from October 1996.

The Rhodes Scholarship was established under the will of Sir Cecil Rhodes in 1902 and selected Rhodes Scholars are expected to possess high intellectual merit, outstanding scholastic attainment, pleasant personality, and physical vigour. It represents one of the highest achievements of young scholars the world over. The scholarship was originally designed for students from the Commonwealth countries, the United States, and Germany. Since 1985, Hong Kong has been included in the scheme and one local student has been honoured as Rhodes Scholar each year.

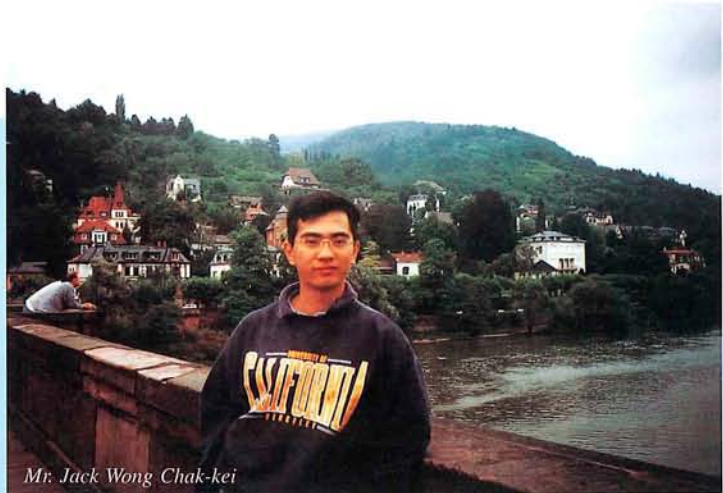

Mr. Jack Wong Chak-kei

BA Students Prove Their Mettle

Students from the Faculty of Business Administration had a taste of the trials and rewards of the world of business and marketing at two recent competitions.

- At the Citibank inter-university marketing strategy competition held in January 1996, two students from the Bachelor of Business Administration Programme — Venus Ho Wing-yan and Irene Tang Hoi-yan, represented CUHK and walked off with the championship after defeating teams from five other universities.

The competition was held in two rounds. In the first round, contesting teams had to design a marketing proposal to acquire 500 new customers for the bank's CitiGold priority banking services. In the second, the teams presented their marketing strategies orally.

Both students found the experience most valuable. They observed that good organization is crucial in proposal writing while simple and creative tactics do the trick in oral presentation.

- The University's BA students also seized the championship in the 10th annual Business Strategy Competition organized by the Hong Kong

Accountancy and Engineering Students Wax Lyrical for Tiny Tots

Children in Hong Kong may soon be singing to the tune of 'Good Health is Like the Sun', a nursery song co-produced by two first-year CUHK students, which won the prizes for best composition and best lyrics at a theme-song-writing contest. The contest, which took place in December 1995, was organized by the Foundation for Children's Health.

Lyric-writer Keith Giang Tsz-sheung from the Department of Computer Science and Engineering feels the University's large and tranquil campus has been a major source of inspiration for him. Composer Ho Tat-man from the School of Accountancy believes the song won because it is simple, catchy and refreshing — everything a nursery song should be.

Keith Giang Tsz-sheung and Ho Tat-man (left 4 & left 5, back row) at the prize-giving ceremony



Federation of Business Students, in which teams from seven local tertiary institutions participated. They had to imagine themselves as the chief executive officer of the giant French retailer Carrefour, and develop the most viable strategy for establishing a Carrefour hypermarket in the best-suited Chinese city.

The competition was held in two parts — one involving a written proposal, and another an oral presentation. In the course of the latter, May Hung, a fourth-year student, won the Best Presenter Award. On the CUHK team were also Mok Sau-han, Tse Tsz-wai, Cheung Suet-mui, Lam Pui-sze, and Cheung Yee-mei.

The CU team for the Business Strategy Competition with Dr. Andrew Chan (left 3) of the Department of Marketing



Another Proud Day for CU Debaters

The 1996 Intersivity Debating Contest

On 23rd March 1996, the CU debating team followed in the footsteps of the seniors before them and defeated their counterparts from the University of Hong Kong in the 1996 Intersivity Debating Contest. The CU team has remained undefeated since 1993.

The prestigious debating contest has a history of 25 years. This year it was hosted by HKU in Lok Yew Hall and conducted in Cantonese. As has been the tradition, the

topic of debate was disclosed only 60 minutes before the competition. Speaking for the motion 'Beijing should use force to reunify Taiwan', CUHK debaters impressed the three adjudicators with their quick wit and eloquence and won the competition by 1291:1272. Shirley Lau Sze-mun, a final year BBA student, was elected Best Speaker. On the CUHK team were also Tang Fei, Betty Kan Kar-ming, and Hui Lung-kit.



The Inter-Postsecondary Debate 1996

The final round of the annual Inter-Postsecondary Debate took place on 7th April in Victoria Park. Now in its 13th year, the debate is organized by Radio Television Hong Kong and the Hong Kong Federation of Students. This year the teams from CUHK and

HKU outperformed seven other participating teams to enter the final. Arguing for the motion 'It is totally unacceptable to boycott the provisional legislature', the CUHK debaters defeated their opponents by four votes to one. Concluding speaker Tang Fei was also selected as the best speaker. The debate was conducted in Cantonese.

The team's latest victory equalizes a record of four victories held by HKU. The CUHK team is also the only perpetual holder of the Champion Cup so far, having won the competition for three consecutive years from 1989 to 1991.





Winning the Intervarsity Games Again

Undergraduate athletes from The Chinese University showed their brawn and overwhelmed their counterparts from the University of Hong Kong in the 16th annual intervarsity games to win their fourth consecutive overall victory since 1992.

The athletic contest was founded in 1980 by the student unions of the two universities, the only one then in the territory, to boost athletic exchange between their students. The universities have since taken turns to host the meet which sports enthusiasts wait months for,

sinews tensed.

This year the competition, hosted by the University of Hong Kong, kicked off with a splash on 29th October 1995 with swimming events. These were followed by athletics, soccer, handball, table-tennis, badminton, tennis, volleyball, basketball, and archery contests as well as squash and softball demonstrations.

In an age when education means more than just the academic report, it is encouraging to see CUHK students show a healthy combination of brains as well as brawn.

Research Newsboard

Joint Research with UK Universities

Seven research projects proposed by staff members of the University recently received grants totalling £43,522.74 (HK\$539,682) from the UK/HK Joint Research Scheme for 1996. The scheme was established in 1991 by the British Council and the Research Grants Council of Hong Kong to promote cooperation in research between institutions of higher education in the UK and Hong Kong. The seven projects selected for support this year are:

- ♦ Field Sampling and Scanning Electron Microscopy of Hong Kong Termites
Researcher: Prof. M.W.J. Crosland (Biology)
Partner Institution: School of Biological Sciences, Queen Mary & Westfield College
Grant: £6,500
- ♦ An Electron Microscopic Analysis of the Effect of Metallic Pollutants on Fungal Propagation
Researcher: Prof. S.W. Chiu (Biology)
Partner Institution: University of Manchester
Grant: £5,563.55
- ♦ Fabrication and Characterization of Magnetic Thin Films on III-V Semiconductors
Researcher: Prof. H.K. Tsang (Electronic Engineering)
Partner Institution: University of Bristol
Grant: £5,996.77
- ♦ Epitaxial Growth of Compound Semiconductor Layers
Researcher: Prof. Ian H. Wilson (Electronic Engineering)
Partner Institution: University of Manchester
Institute of Science and Technology
Grant: £6,425.81
- ♦ Investigations of the Cellular Mechanisms Underlying the Turning of Uncrossed Retinal Axons at the Midline of the Optic Chiasma
Researcher: Prof. S.O. Chan (Anatomy)
Partner Institution: University of Oxford
Grant: £6,110
- ♦ Neuropeptide Induced Mediator Release from Mast Cells: Effects of Non-peptide Antagonists of Neurokinins
Researcher: Prof. Alaster H.Y. Lau (Pharmacology)
Partner Institution: University College London
Grant: £6,495
- ♦ Similarity and Preference as Determinants of Stimulus-response Compatibility
Researcher: Prof. Lu Chen-hui (Psychology)
Partner Institution: University of London
Grant: £6,431.61

HK\$4.239 Million from Industrial Support Fund for Two CUHK Research Projects

The Industry and Technology Development Council recently approved an allocation of HK\$4.239 million from the Industrial Support Fund to finance two projects undertaken by members of the University:

- ♦ HK\$762,800 for 'Expression of Recombinant Proteins in Baculovirns and the Application of Recombinant Fish Growth Hormone in Fish Culture' by Prof. Walter K.K. Ho of the Department of Biochemistry.
- ♦ HK\$3.477 million for 'A Chinese Internet Information Server and the Server Access Software' by Prof. Lee Kin-hong, Prof. Lu Qin and Prof. Wong Chak-kuen of the Department of Computer Science and Engineering.

Highlights of Four Research Projects

To generate more interest in the University's research activities, the *Chinese University Bulletin* continues to bring to readers highlights of research projects supported by RGC earmarked grants.

The *Bulletin* has worked closely with the principal investigators of four projects to explain their research objectives, procedures, and achievements in terms comprehensible to the lay person. The four reports can be found on pages 23 to 32.

New Developments in the Application of Structural Equation Models

Statistics today has many important applications in various fields. Amongst the most common of these applications is the establishment of a statistical model to reveal the underlying phenomena in a particular situation, and the subsequent use of this model to arrive at correct decisions and conclusions.

Two Kinds of Variables in Substantive Theory

In behavioural, educational, medical, and social science, substantive theory (which is concerned with real issues or real effects) usually involves two kinds of variables, namely, the observed and latent variables. Observed variables are those that can be measured directly, like income, test scores, weight, etc. Variables that cannot be measured

directly are called latent variables. Examples of these can be intelligence, quantitative ability, health condition, buying behaviour, etc. In practice, a system of equations can be used to denote the characteristics of a latent variable which are reflected by a number of observed variables. Usually, the causations and correlations among the observed and latent variables form the integral part of the theory underlying such a system of equations, and structural equation modelling is the most important and useful statistical technique in assessing these relations.

Dr. W.Y. Poon obtained her B.Sc. in mathematics (1983) and M.Phil. in statistics (1985) from CUHK, and her Ph.D. in biostatistics from the University of California at Los Angeles in 1987. She returned to the Department of Statistics at CUHK as a lecturer in 1987 and was promoted to senior lecturer in 1995.



Dr. S.Y. Lee obtained his B.Sc. in mathematics from CUHK in 1972, and his Ph.D. in biostatistics from the University of California at Los Angeles in 1977. He returned to the Department of Mathematics at CUHK as a lecturer in 1977, transferred to the Department of Statistics in 1982, and was promoted to reader rank in 1990.

An Example of Structural Equation Modelling

We can consider an example of the application of structural equation modelling. The path diagram below represents a model of student growth study conducted at the Education Testing Service in the USA based on some longitudinal data (see, e.g. Jöreskog & Sörbom, 1989). In this model, there are several latent variables: quantitative ability (Q) and verbal ability (V) at grades 7 and 9; and several observed variables which are the students' scores on the following tests at grades 7 and 9: mathematics (MATH), science (SCI), social studies (SS), reading (READ), the verbal (SCATV) and quantitative (SCATQ) parts of the Scholastic Aptitude Test.

As can be seen in the path diagram, latent variables are all related to some appropriate observed variables: 'straight' arrows represent causations and 'curved' arrows represent correlations. Each of these arrows contributes a parameter in the model that requires to be estimated. Based on the analysis of the model, several conclusions can be drawn. For instance,

the verbal ability at grade 7 (V_7) has no causal effect on the quantitative ability at grade 9 (Q_9), but it has a causal effect on the verbal ability at grade 9 (V_9) with a magnitude to be determined by the parameter β_{42} .

Similar path diagrams are normally adopted to facilitate the developing and specifying of structural equation models. In order to obtain detailed analyses of such models, a general computer program is also required.

Data that Precludes Application of Structural Equation Models

Now, with the help of the efficient programs LISREL VII (Jöreskog & Sörbom, 1989) and EQS (Bentler, 1992), structural equation models have been widely used to analyse practical situations. Like most statistical methods, correct applications are based on certain assumptions. For this technique, the most important assumptions are that the variables are continuous and the observations are independently distributed.

As this methodology has increased in popularity, there is a strong demand for its

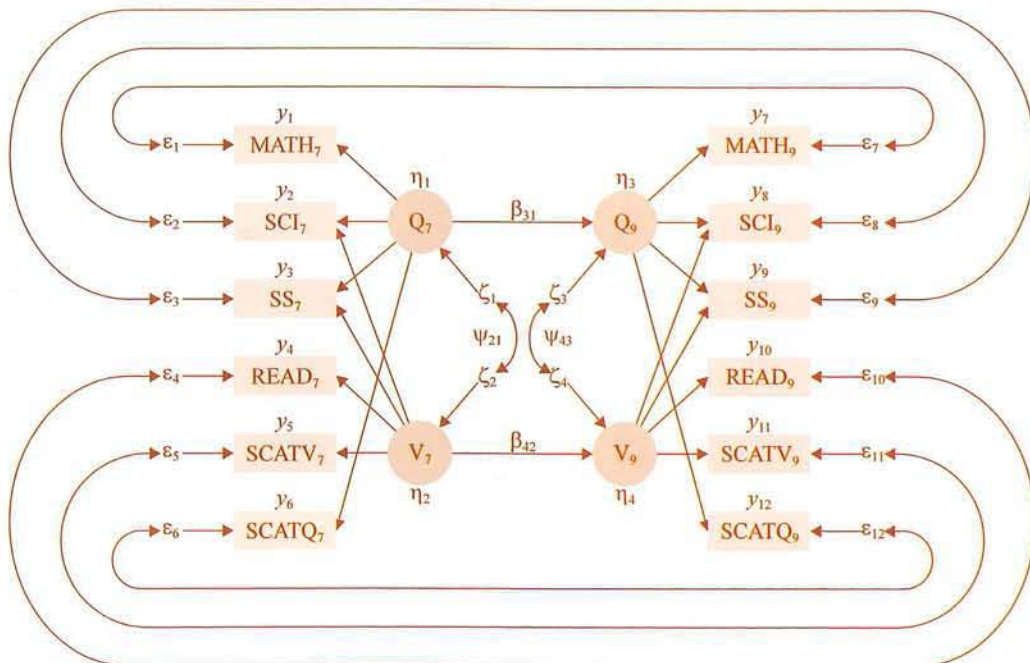

Path diagram of a model of student growth. Observed and latent variables are represented by rectangles and circles respectively; straight arrows represent causations and curved arrows represent correlations.

extension to cope with more complex situations. Recently however it has been realized that there are three important types of non-standard data that violate the above-mentioned assumptions, and hence cannot be satisfactorily handled by the existing theory and programs.

The first type of non-standard data are obtained from variables whose manifestations are only observable in a discrete (i.e. separate and distinct) polytomous (divided into more than two secondary parts of branches) form. Due to the nature of questionnaires involved, these polytomous variables are most common in behavioural and social research, as for instance in attitude items, performances items, rating scales, etc. A typical case is to ask a subject to report some attitude on a scale like: Disagree, No opinion, Agree. The assumption of continuity is obviously not valid for such data.

The second type refers to data that are multilevel in nature, for example those obtained by samples of randomly drawn students from randomly drawn schools, or randomly drawn workmen from randomly drawn factories. As these individuals are drawn from the same group, they are expected to be influenced by certain common factors and hence produce observations that are correlated rather than independent.

The last type refers to censored data that are frequently encountered in medical, industrial and economic studies. Such data consist of times to the occurrence of an event, such as the death of an experimental animal, the birth of a child, and the failure of a light bulb. For some units in the sample, time to occurrence is censored because the event has not occurred before the termination

of the experiment. If only the time of censorship is recorded, information about the situation becomes incomplete — we only know that the event has failed to occur by the censorship time. While analysing the data relating to these situations, information needs to be handled carefully if incorrect results are to be avoided.

Successful Research Efforts at CUHK to Include Such Data

The aforementioned problems that structural equation models encounter with non-standard data have been investigated by Dr. S.Y. Lee and Dr. W.Y. Poon of the Department of Statistics, with the support of a grant of HK\$440,000 awarded by the UGC Research Grants Council in 1991. They have successfully developed some efficient procedures and computer programs to solve the problems, and elucidated the associated statistical properties for model analysis. Studies in Monte Carlo indicate that the results obtained are satisfactory, and hence some of them have been adapted by the well-known EQS program.

Thanks to the good work of CUHK researchers, structural equation models can now be applied to situations that involve the three major types of non-standard data. The researchers will continue to improve and refine the statistical methodologies so that such models can be applied to problems and situations that are even more complex. □

References

Bentler, P.M., *EQS: Structural Equation Program Manual*, Los Angeles: BMDP Statistical Software, 1992.

Jöreskog, K.G. & Sörbom, D., *LISREL VII: A guide to the Program and Applications*, Chicago: SPSS Inc., 1989.

334 *Sik-Yum Lee, Wai-Tin Poon and P. M. Bentler*
 Table 4. RMSE between the PMM-GLS estimates and the true values, for a multivariate F distribution with $d.f. = 5$

Threshold type	True parameters	$r = 0.2, \rho = 0$			
		$T = 100$	$T = 200$	$T = 300$	$T = 400$
SF	$B_{11} = 0.2$	0.179	0.113	0.081	0.075
	$B_{21} = 0.3$	0.130	0.113	0.095	0.099
	$B_{31} = 0.3$	0.121	0.096	0.066	0.065
	$B_{41} = 0.3$	0.081	0.044	0.022	0.081
S2	$B_{11} = 0.2$	0.142	0.116	0.079	0.125
	$B_{21} = 0.3$	0.117	0.116	0.078	0.128
	$B_{31} = 0.3$	0.109	0.091	0.063	0.102
	$B_{41} = 0.3$	0.088	0.049	0.033	0.152
AS1	$B_{11} = 0.2$	0.139	0.117	0.083	0.094
	$B_{21} = 0.3$	0.147	0.112	0.074	0.085
	$B_{31} = 0.3$	0.121	0.088	0.063	0.079
	$B_{41} = 0.3$	0.063	0.056	0.028	0.082
AS2	$B_{11} = 0.2$	0.136	0.114	0.082	0.120
	$B_{21} = 0.3$	0.135	0.114	0.078	0.125
	$B_{31} = 0.3$	0.114	0.094	0.065	0.084
	$B_{41} = 0.3$	0.062	0.059	0.024	0.078

Xianggu Mushroom

How to Make it Palatable to Both the Taste Buds and the Pocket

The tasty and versatile *Xianggu* mushroom is a favourite on Chinese dinner tables, in haute cuisine as in more homely fare. It can cost from under a hundred dollars to a few hundred dollars per catty, depending on the quality. Different grades of *Xianggu* are the result of differences in the strains or in the cultivation processes.

To Develop a Breeding Programme for Xianggu

There have not been, however, any breeding programmes for *Xianggu* similar to plant breeding programmes. Traditionally the better strains have been selected only after time-consuming and labour-intensive screening, which adds to the overall production cost. But since 1993, Prof. H.S. Kwan of the *Xianggu* mushroom molecular biology research programme at The Chinese University of Hong Kong has striven to make *Xianggu* more palatable to both the taste buds and the pocket. The programme tries to develop and apply state-of-the-art molecular biological technology for the improvement of *Xianggu* mushroom strains, and three of its projects have received funding from the Research Grants Council three years in a row since 1993 (see box).

The projects have different focuses but share in common two objectives: (1) to plot a molecular genetic map of the *Xianggu* mushroom, and (2) to isolate and manipulate genes that are important for the cultivation of quality *Xianggu* mushroom.

To Plot a Genetic Map

To facilitate the construction of strains with desirable qualities, researchers need the help of a molecular genetic map to identify and locate the agronomically important genes in the *Xianggu* mushroom genome. Prof. Kwan and his team have so far generated over 70 molecular markers and located two mating-factor genes. A molecular genetic map has been plotted based on this information (see p. 27). It is hoped that eventually genes that are conducive to tastiness, succulence, and rapid growth can be identified, isolated, and reshuffled into a single strain. Plentiful yields of quality *Xianggu* mushroom may thus result.

RGC-supported Research

<i>Project</i>	Generation of Molecular Markers for Construction of a Genetic Map and Characterization of Genetic Determinants of Some Phenotypic Traits in Shiitake Mushroom (<i>Lentinula edodes</i>) 1993
<i>RGC grant</i>	HK\$756,000
<i>Project</i>	Identification and Molecular Cloning of Differentially Expressed Genes Involved in Lignocellulose Utilization in Shiitake Mushroom (<i>Lentinula edodes</i>) 1994
<i>RGC grant</i>	HK\$583,000
<i>Project</i>	Molecular Cloning and Time Course Studies of Genes Specially Expressed during Fruit Body Development in Shiitake Mushroom (<i>Lentinula edodes</i>) 1995
<i>RGC grant</i>	HK\$713,000

Gene Manipulation

Researchers set their eyes on two types of genes in particular: those involved in fruiting body development, and those involved in the degradation of lignocellulosic materials in the growth substrate. Once such genes have been identified, they will be cloned for further analysis. Gene cloning is the process by which a vector inserted with an isolated gene is placed inside a suitable organism, often some bacterium, to produce multiple copies of that gene.



A genetic linkage map of Xianggu Mushroom

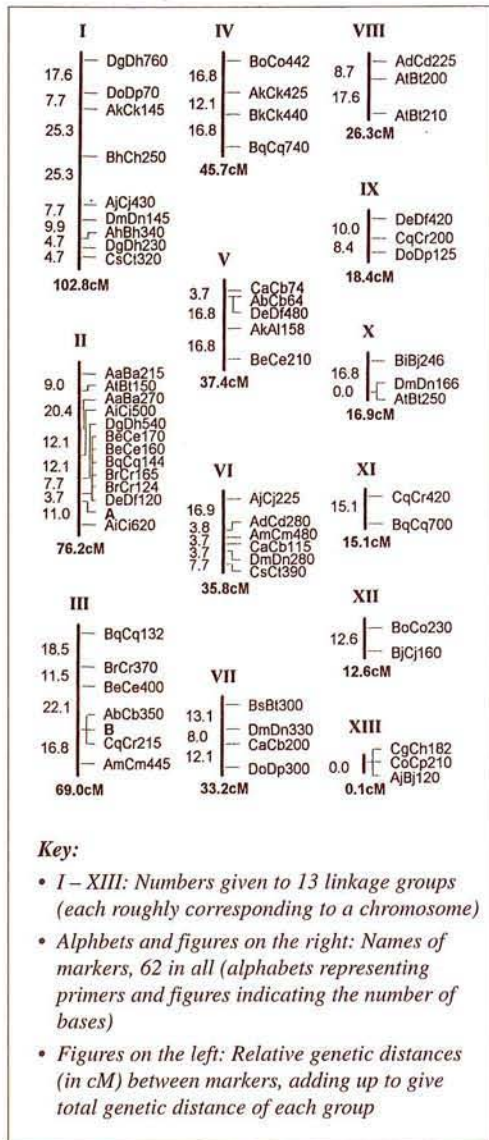

Fruiting Body Development

Fruiting body development refers to the actual process of fungal growing from mycelium into mushrooms. It is a very complex process which has been poorly studied in the past. Advances in the polymerase-chain-reaction-based RNA fingerprinting method have now enabled researchers to identify and clone genes that are expressed specifically during Xianggu's fruiting body development. More than 10 putative 'fruiting genes' have been identified, several have been cloned and analysed, and more are expected to undergo these processes. The functions of these genes can be inferred by comparing their DNA sequence with the known genes in the GeneBank

of the National Center for Biotechnological Information in the United States. The information thus acquired will be used to identify the key steps during fruiting body development and to construct a model of the process. 'Fruiting genes' may also be manipulated to shorten the fruiting process and to increase yields.

Degradation of Lignocellulosic Materials

Mushrooms do not carry out photosynthesis but rely on extracellular enzymes to degrade complex organic matters into soluble substances as nutrition. As materials that are most widely adopted as growth substrates for mushrooms are lignocellulosic, researchers in Prof. Kwan's laboratory want also to identify genes that are expressed specifically during growth on lignocellulosic substrates. They do it by RNA fingerprinting and other approaches, and a relevant gene has been identified and cloned. This gene can be shuttled back into the mushroom to improve growth and fruiting efficiency.

Wide Applicability of Research Results

Many researchers are now beginning to delve into the myriads of possibilities of the Xianggu mushroom, such as using it to make health foods and for seasoning, analysing its anti-tumour/anti-viral properties, and tapping its other medicinal potentials. Growing better mushrooms tomorrow will certainly affect more than just the palate. □



Prof. Kwan Hoi-shan received his Ph.D. from the University of California at Davis in 1982 and is currently associate professor in the Department of Biology at The Chinese University of Hong Kong. His research interests include molecular genetic analysis of edible mushrooms (*Lentinula edodes*) for strain typing, genetic maps, and breeding programmes; molecular cloning, analysis and utilization of cellulose and ligninase genes from edible mushrooms; and molecular genetic studies of fruit-body development of shiitake mushrooms (*Lentinula edodes*). Since 1986, Prof. Kwan has been the recipient of five RGC/UGC Earmarked Research Grants and three Croucher Foundation Research Grants.

Similarity Breeds Curability

Applying Findings on Cervical Cancer to the Diagnosis of Nasopharyngeal Carcinoma

Long Duration in the Progression of Cancer

Cancer is a dreaded disease, all the more so since we are frequently exposed to images of it in its later stages — after it has destroyed tissues and organs, caused failure of function, and eventually death. While the precise events in the progression of cancer are not yet known, what we do know now is that there is a long interval between the first event that initiates cancer and its full clinical manifestation.

The Process of Carcinogenesis

Research done on animals in the course of this century and numerous clinical observations have contributed to our present understanding of carcinogenesis, i.e. the process of the genesis of cancer. For instance, repeated application of coal tar on rabbits' ears produced cancers of the skin. The procedure first induced papillomas (benign tumours), followed by carcinomas (malignant tumours). Further research revealed that there were changes in the cells of the skin long before the papillomas appeared, and there was another long interval before carcinomas were produced.

Precancerous Changes

While cancer statistics record deaths and diagnoses, they seldom record the incidence of those who harbour cancer cells which may develop into cancer. It is in fact possible now to detect precancerous changes in the respiratory tract, the urinary tract, the gastrointestinal system, the oral cavity, and the female genital tract, thanks to the hard work of generations of medical researchers.

The Case of the Uterine Cervix

Of the various sites mentioned, the best understood is that of the cancer of the uterine cervix. In the late nineteenth century, precise diagnosis of the cancer became possible with the introduction of histopathology, i.e., what a pathologist can see from a biopsy. However, a

biopsy involves discomfort for the patient, for an operation has to be performed to take living cells from the uterine cervix for purposes of study and diagnosis.

The next significant breakthrough came with the introduction of the Pap smear method which involves the use of exfoliative or abrasive cytological techniques. A smear of exfoliative cells (as opposed to living cells in a biopsy) from the uterine cervical lining is placed on a glass slide; the addition of some chemicals enables a study of the size, shape and colour of the cells, which can indicate whether the cells are cancerous. The method does away with the operative discomforts and the cost of taking biopsies while yielding the same accuracy. The changes as indicated by a Pap smear correlate well with what a pathologist can see from a biopsy of the cervix. This and the fact that it is a relatively easy test has resulted in its wide application for the screening and early diagnosis of cervical cancer, and has in many instances enabled a cure of the disease before it reaches the invasive stage.

The Case of the Human Nasopharynx

Histologically, the structure of the cells lining the human nasopharynx is curiously similar to that of the cervix. This prompted experts from the

Precancerous Changes

Uterine Cervix

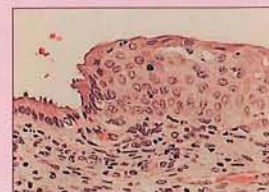

Hyperplasia

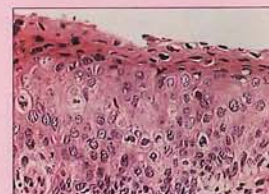

Carcinoma-in-situ

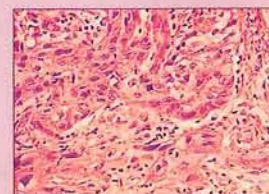

Carcinoma of Cervix Uteri

University to undertake research to find out if precancerous changes of the nasopharynx are similar to those of the cervix. The research team comprised Prof. Joseph C.K. Lee, Prof. Dolly W.S. Huang, Prof. Michael W.M. Suen and Mr. L.J. McGuire of the Anatomical and Cellular Pathology Department, Dr. H.G.S. Murray of the Microbiology Department, and Prof. C.A. van Hasselt of the Surgery Department. They were awarded a competitive grant of HK\$ 620,000 by the Research Grants Council in 1989 to carry out their research.

Using tissue from over 300 biopsies taken from suspected nasopharyngeal carcinoma patients and from 200 human nasopharynxes removed at autopsies, they characterized and defined the changes involved in the development of nasopharyngeal carcinoma. Four different methods were employed.

First, the researchers conducted histological studies wherein tissues were fixed in formalin and embedded in paraffin. Very thin sections (0.005mm) were cut and stained and then viewed under the microscope. The diagnosis was based on colour change, intensity of staining, and the relationship between different tissue components. The appearance of cells, in terms of the amount of

cytoplasm and size and shape of nuclei and nucleoli, was also observed.

Morphometric methods were then used to measure the size and distribution of cells in the epithelia of many sections of each specimen. The process was very time-consuming and tedious. In some cases, serial sections were taken to observe the relationship of one group of cells to another. After collecting an enormous amount of data, all information was subjected to statistical analysis to ascertain the effect of a large number

of variables.

Researchers can use chemicals to react with specific substances in a cell or tissue to give a colour indicating the nature of a substance, a method called histochemistry. The CUHK team used immunohistochemistry in their research, in which colour reaction is extended further by exploiting the mechanism of antigen-antibody detection in tissues. Appropriate controls help the results to be specific and quantifiable, and the amplification achieved renders the method sensitive, which is why it is used extensively in research and diagnosis in pathology.

The researchers also used lectins (plant products that have specific affinity to carbohydrates on cell surfaces) to distinguish abnormal cells from normal cells. The carbohydrate components recognized by some lectins are not present in normal nasopharyngeal epithelium, but show variable changes when the cells become abnormal.

After in-depth and extensive studies, the researchers finally came to the conclusion that precancerous changes at both sites, i.e. the cervix and the nasopharynx, are highly similar. Corresponding to the three stages of precancerous change of the cervix CIN I, II, and III (CIN denoting the intraepithelial neoplasia of the cervix), the researchers defined those of the nasopharynx as NPIN I, II, and III.

Direction of Further Related Research

These research efforts are now being furthered by other experts in the Anatomical and Cellular Pathology Department, who wish to ascertain whether a smear method can also be used to diagnose cancerous changes in the nasopharynx as easily and accurately as in the case of the uterine cervix. The road ahead could be arduous and long, bearing in mind the 50 years of hard work and experience that preceded the success of the Pap smear method.

We are now witnessing the development of automatic screening of Pap smears by machines, which can check human error or oversight in the diagnosis of cervical cancer. Spurred on by such progress, the research team headed by Prof. Joseph C.K. Lee hopes that, with more research and systematic collection of accurate data, cytological screening of nasopharyngeal carcinoma using exfoliative cytology can soon be a reality in Hong Kong. This would enable its early detection, and possibly cure, before it reaches the invasive stage. □

Nasopharynx

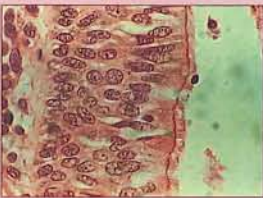

Hyperplasia

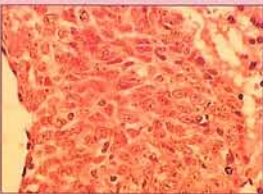

Carcinoma-in-situ

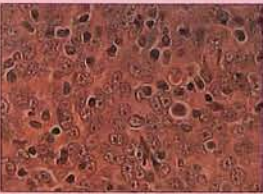

Nasopharyngeal Carcinoma

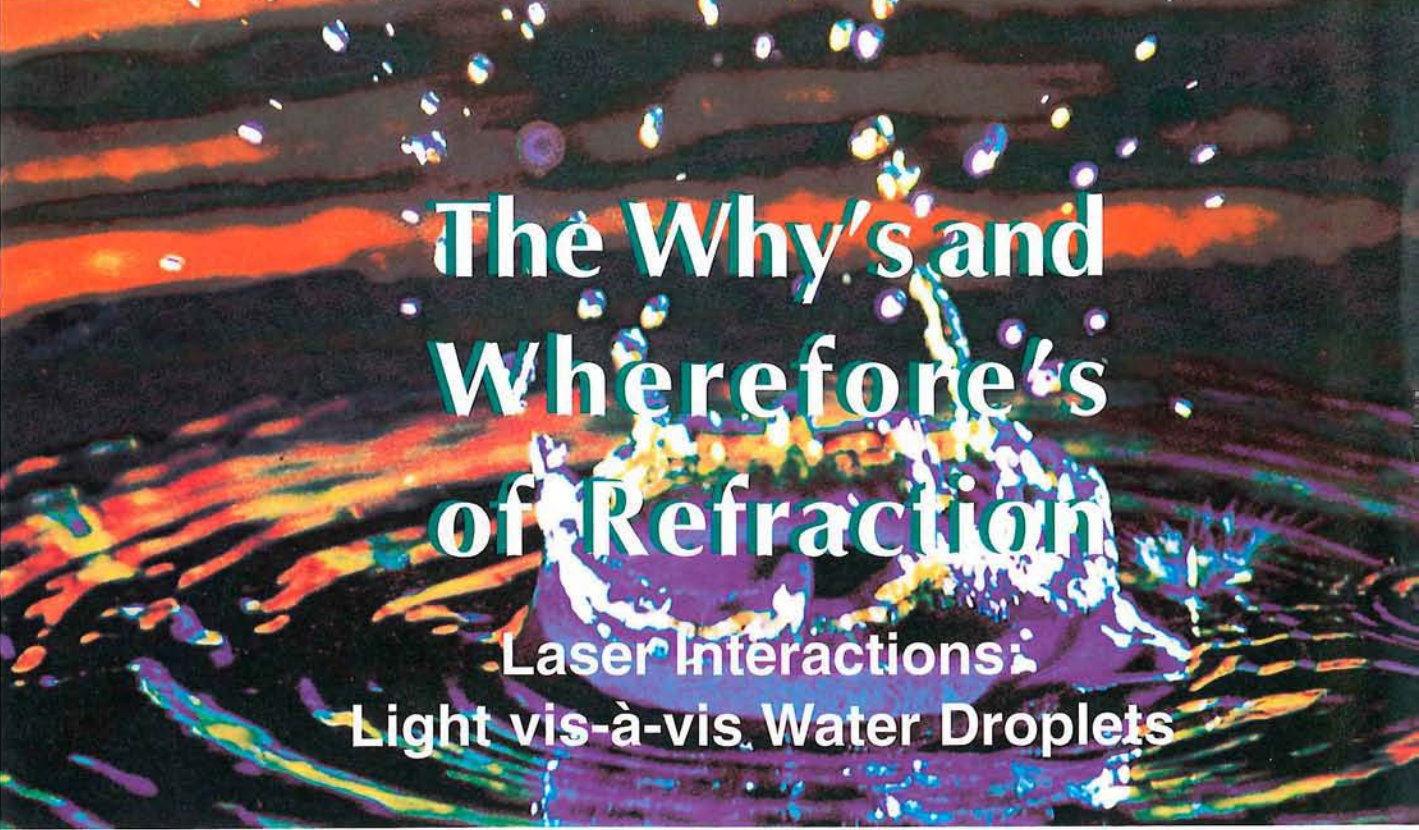

The Why's and Wherefore's of Refraction

Laser Interactions: Light vis-à-vis Water Droplets

How does strong light interact with transparent refracting material such as water droplets? A research project by Prof. H.M. Lai and Prof. K. Young of the Department of Physics to study this phenomenon won an 'excellent' rating by the Research Grants Council, an honour it shared with seven other CUHK research projects. A total of only 13 projects have been so rated in Hong Kong.

Events That Raised Interest in the Subject

Although funding from the Research Grants Council (RGC) was only applied for in the late 1980s, the two researchers became interested in the subject about 20 years ago, when both as new lecturers in the department became aware of a Bell Labs experiment which showed that a strong beam of laser shone perpendicularly onto a liquid surface did not push the surface in, but instead drew it upwards. This contradicted all conventional notions of radiation pressure, and was all the more strange since electromagnetism was supposed to have been completely understood for over a century. A chance visit by Prof. Sir Rudolph Peierls, head of the physics department at Oxford, pointed the way to a new approach. The critical issue, which the investigators recognized, is that the

molecules re-arrange themselves in the presence of light energy, and a complete solution can be found for moderately long pulses of light passing through transparent refracting material.¹ W.M. Suen worked on this problem for his M.Phil. thesis, and has since obtained his Ph.D. from Caltech in general relativity, become tenured in Washington University, and in 1995 won the Outstanding Young Researcher Award from the Overseas Chinese Physicists Association in the United States. He is currently an associate professor in the University's Department of Physics for one term.

The early work on laser interaction with bulk liquids foreshadowed later investigations into interaction with microdroplets. The next major development came about through yet another chance visit, this time by Prof. Richard Chang of Yale University, in the mid-1980s. There was then much interest in what happens when an intense laser pulse runs into fog — a collection of transparent microdroplets. Since this problem involves precisely the force exerted by light on a transparent liquid, the group at CUHK was one of the few that had the knowledge to solve it, and research results agreed precisely with experiments using single microdroplets.²

The Effect of the Liquid on the Light

This work answered the question of what the light does to the liquid, but in many ways the other half of the problem — what the liquid does to the light — was more interesting. Light can suffer total internal reflection at the microdroplet interface, and become trapped in a closed path (Fig. 1). If the length of the closed path is an integral number of wavelengths, the electromagnetic field can form a resonance. This is analogous to the vibrations of a violin string — if the round trip path between the two clamped ends is an integral number of wavelengths, a standing wave, or resonance, is formed (Fig. 2). Many groups had

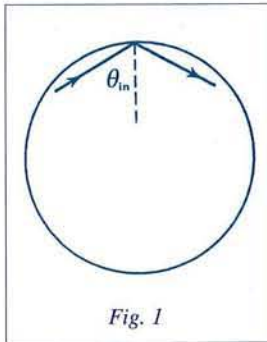

Fig. 1

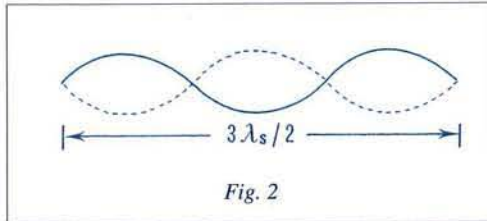

Fig. 2

observed these resonances spectroscopically, and realized their importance in nonlinear optics. In particular, optical feedback in these spherical systems has led to lasers about 1/100 mm in size, probably a world record in miniaturization. Moreover, since wavelength is proportional to circumference, this technique allows monitoring of the droplet size, e.g., the size of diesel fuel droplets in internal combustion engines.

However, there is one major difference between the resonances on a violin string and the optical resonances in a microdroplet. In the latter, the laws of electromagnetism dictate that a tiny part of the electromagnetic energy will leak to the outside. When energy does not remain constant, many conventional tools of theoretical physics need to be modified. The CUHK group was able to give a precise

definition of what is meant by a resonance in these circumstances, and to show that this leads to better understanding of many optical phenomena.³ The most intriguing observation is that atomic and molecular life-times can be drastically reduced (and sometimes increased) when atoms and molecules are situated in a nontrivial environment such as a microdroplet or a cavity, even though they have no contact with the walls of the cavity. Emily Ching worked on this problem for her M.Phil. thesis, and the paper based thereon has become a standard reference.³ Ching has since obtained her Ph.D. from Chicago University working on nonequilibrium nonlinear systems, in particular turbulence, and rejoined the department as a lecturer in 1995.

Achievements of Research in Optical Interaction with Microdroplets

With this set of tools in hand, the group felt that it was in a unique position to tackle a large number of phenomena in the area of optical interaction with microdroplets, and in 1988, Lai and Young obtained an RGC grant of HK\$100,000 to work on these issues. P.T. Leung, then a Ph.D. student in the group, was a co-investigator; he has since become a lecturer in the Department of Physics.

A variety of problems were tackled, and understood, including Brillouin scattering, the splitting of resonances, the precession of photon orbits, the degradation of resonances due to minor changes in shape. At the same time, Lai, Leung and Young realized that many of these issues are relevant to all quantum systems from which energy is lost to the environment — for which there is a dearth of standard mathematical tools. So, another thread of the project, possibly the more important one in the long run, is to generalize the standard tools of mathematical physics to such open systems. An important result, principally due to Leung's efforts, is that the resonances in many situations actually give a complete description of the system, in a precise mathematical sense. This generalizes the classic works of many, including Fourier, and Sturm and Liouville. Prof. S.Y. Liu of the University of Science and Technology of China, as well as a number of CUHK students, all made

important contributions. Some of the subsequent work was also supported by a Croucher Foundation grant.

The formalism is applicable to many systems that lose energy to the environment. It turns out that gravitational waves emitted from black holes constitute one such system, formally very analogous to electromagnetic waves emitted from microdroplets — even though the length scales differ by a factor of a billion. The researchers at CUHK, together with W.M. Suen, have achieved a much clearer understanding of the behaviour of such waves, which are expected to be detected within the next decade.⁴

Future Research in the Field

The new approach opens up many research directions. In June 1995, Ching, Leung, Suen and Young were awarded another RGC grant to study waves in open systems in general, while Leung and Lai were awarded an RGC grant to study specific optical phenomena in microdroplets. Both are the outgrowths of the original project awarded in 1988. Speaking of this long-term project, both Prof. Lai and Prof. Young feel that future developments will depend principally on the younger members of the team. As regards themselves, the project has been gratifying not only because of the scientific results, but also because it has provided opportunities for a home-grown team to be nurtured. □

References

1. H.M. Lai, W.M. Suen & K. Young, *Phys. Rev. Lett.*, **47**, 177 (1981); *Phys. Rev.*, **A25**, 1755 (1982).
2. H.M. Lai, P.T. Leung, K.L. Poon & K. Young, *J. Opt. Soc. Am.*, **B6**, 2430 (1989).
3. E.S.C. Ching, H.M. Lai & K. Young, *J. Opt. Soc. Am.*, **B4**, 1995 (1987).
4. E.S.C. Ching, P.T. Leung, W.M. Suen & K. Young, *Phys. Rev. Lett.*, **74**, 2414 (1995).



From left: W.M. Suen, H.M. Lai, P.T. Leung, K. Young, E.S.C. Ching, S.Y. Liu and S.S. Tong.



Prof. Kenneth Young is a theoretical physicist.

He obtained his BS and Ph.D. from the California Institute of Technology in 1969 and 1972 respectively, and joined CUHK in 1973.

His research interests cover a wide range of subjects including high energy physics, optical physics, electrodynamics, meteorology, etc. He is a professor of physics and is serving concurrently as a pro-vice-chancellor of the University, and dean of the Graduate School.

Prof. Hon-Ming Lai obtained his B.Sc. from

CUHK in 1967 and Ph.D. from Dartmouth

College in the United States in 1971. He

joined CUHK as lecturer in 1974. He is a

theoretical physicist with research interests in

plasma physics, electrodynamics, and optical

physics. He is a professor in the Department

of Physics and is serving concurrently as

chairman of the department.

Profiles

Prof. Lee received his BA, *summa cum laude*, from the University of Hawaii and his Ph.D. degree from the Massachusetts Institute of Technology. His doctoral dissertation was about the development and impact of rural non-farm enterprises in China. Prof. Lee was made a Fellow of the East-West Center in Honolulu, Hawaii, in January 1989 and has since conducted research on a wide range of urban environmental management issues in Asia and the Pacific region, including water supply and sanitation, housing, environmental management in low-income settlements, non-governmental and community-based organizations, privatization, and Asia's environmental movements. He has also served as an affiliated faculty member in the Department of Sociology and the Department of Urban and Regional Planning at the University of Hawaii from 1991.



Prof. Yok-shiu F. Lee
Assistant Professor
Department of Sociology

Prof. Lee has been a consultant to the World Bank, the United Nations Economic and Social Commission for Asia and Pacific, the United Nations Centre for Regional Development, and the World Resources Institute. He has published in international journals such as the *China Quarterly* and the *Asian Journal of Environmental Management*, and has written for *Newsweek International*. He has authored and co-authored over 30 journal articles, book chapters, and professional reports.

Upon graduating with a BA degree from the University of Hong Kong, Miss Yu worked as an executive trainee for the Swire Group. She then furthered her studies in Germany and obtained her MBA degree from Hamburg University. Most of her working experience thereafter was acquired in the private sector until recent years when she served in The Community Chest of Hong Kong as secretary to key committees and subcommittees, including the Admissions, Budgets and Allocations Committee, the Investments and Endowment Funds Subcommittee, the Public Relations Committee, the Marketing and Publicity Strategies Subcommittee, and the Membership Drive Organizing Committee.



In the University's Office of Student Affairs, which she joined in December 1995, she is responsible for developing two key services for students — the Appointments Service, and Scholarships and Financial Aid.

Miss Yu Tsih-wah Nancy
Senior Student Affairs Officer
Office of Student Affairs

Dr. Wan Chin-chin
Director
School of Continuing Studies

Dr. Wan Chin-chin completed her secondary education in Hong Kong, graduated with a B.Sc. degree in physical chemistry and mathematics from Seattle Pacific University, and obtained her Ph.D. in biophysics from the University of Western Ontario. She was awarded a diploma in management of lifelong education by the Harvard Graduate School of Education in 1986 and a certificate in higher education management by Ohio University in 1987.



Dr. Wan has had extensive experience in teaching and administration in tertiary institutions, in the area of continuing and professional education in particular. She once served as instructor and laboratory supervisor at Tulane Medical School in New Orleans, and teaching assistant in biophysics and demonstrator in physics at the University of Western Ontario in Canada. Upon returning to Hong Kong in 1979, she joined Hong Kong Baptist College (now Hong Kong Baptist University) as special assistant to the president. Six months later, she took up the posts of coordinator of the International Baccalaureate Programme, lecturer in chemistry, and assistant director of the Basic Studies Programme.

In 1982 Dr. Wan left Hong Kong for Macau where she became vice-principal of the Junior College of the University of East Asia (now University of Macau) after one year as the founding director of studies. A year later she rejoined Hong Kong Baptist College as head of the Division of Continuing Education. Before joining The Chinese University as director of the School of Continuing Studies in February 1996, she was dean of the School of Continuing Education of Hong Kong Baptist University for over six years.

Dr. Anthony E. James
Director
University Animal House



Dr. James graduated from the University of Melbourne in 1977 with a Bachelor of Veterinary Science (Honours) degree. He has specialized in laboratory animal medicine and management since 1986. He has a postgraduate certificate in management and belongs to the Australia College of Veterinary Scientists.

Dr. James has high expectations of living in Hong Kong and working in The Chinese University. He hopes to contribute to the medical and scientific research community on campus through the provision of a world class laboratory animal service.

Dr. James is married and has two children. He is interested in sports, specially tennis, long distance running, and baseball. His hobbies include bee keeping, poultry keeping, and beer brewing.

Born in Guangzhou, China, Prof. Albert Lew grew up in Hong Kong, and completed his secondary school education in the territory before emigrating to the United States.

He received his bachelor's degree in accounting from San José State University, his MBA from the University of Utah, his Master of Accountancy from Virginia Polytechnic Institute and State University, and his Ph.D. in accountancy from the University of Nebraska at Lincoln. He taught both undergraduate and graduate accounting at the University of Nebraska, Wright State University, the University of Wisconsin Oshkosh, and the Hong Kong Polytechnic University before joining The Chinese University in September 1995.



Prof. Lew's research interests lie in accounting theory, financial reporting, and the application of quantitative models in accounting. He is a member

of the American Institute of Certified Public Accountants, the Arkansas Society of Certified Public Accountants, and the American Accounting Association. His publications have appeared in various US academic and professional accounting journals.

Prof. Albert Lew Yee-hong
Associate Professor
School of Accountancy

Prof. Heng received his B.Sc. in computer science from the National University of Singapore (1985), and his M.Sc. in computer science (1987), MA in applied mathematics (1988), and Ph.D. in computer science (1992) from Indiana University.

From 1992 to 1995 he worked as a research scientist at the ISS-JHU Center for Information-enhanced Medicine (CIeMed), which is a medical research centre formed by the Institute of Systems Science (ISS) at the National University of Singapore and the Johns Hopkins University (JHU). From 1993 to 1994 he was a visiting scientist at the Medical School of JHU where he started and led the CIeMed cardiac visualization project. He was also the project leader and chief designer of a major medical visualization system developed at ISS. This was later turned into a commercial product.



Prof. Heng has produced several computer-animated videos on mathematical and medical visualization. These videos have been telecast or presented in Canada, France, Germany, Japan, Monaco, the Netherlands, Norway, UK, Slovenia, and USA.

His current research interests include interactive scientific visualization, 3D medical imaging, computer graphics, and virtual reality applications.

Prof. Heng Pheng Ann
Assistant Professor
Department of Computer Science
and Engineering

Prof. Zuowei Xie
Assistant Professor
Department of Chemistry

Prof. Xie was born in a small city of southern China and graduated with a BS degree in chemistry from Hangzhou University in 1983. He received his MS degree from the Shanghai Institute of Organic Chemistry, Chinese Academy of Science in 1986, and his Ph.D. degree in chemistry in 1990 under a joint Ph.D. programme between the Shanghai Institute of Organic Chemistry and Technische Universität Berlin.



Prof. Xie was a research associate at the Shanghai Institute of Organic Chemistry in 1990–91 when he won the young chemist award of the Chinese Chemical Society. He then worked at the University of Southern California as a research associate for over three years.

His research interests include organometallic and coordination chemistry of f- and d-block transition metal complexes, homogenous catalysis and coordinative unsaturation, metallocarborane, and weakly coordinating anions. He has more than 26 publications to his credit. Prof. Xie's works on silicon and boron chemistry have twice been highlighted in the prestigious *Chemical and Engineering News*.

New Professorial Appointments

Prof. A.E. Mackenzie
Professor of Nursing

Prof. A.E. Mackenzie has been appointed professor of nursing (clinical nursing) from 1st June 1995.

Prof. Mackenzie moved from the practice of community nursing to nurse education in 1978. She obtained her MA in education from the University of London in 1984 and her doctorate from the University of Surrey in 1990. Before joining The Chinese University in 1993, she was lecturer in nursing in various institutions of higher education in Essex and at the University of London. She has had extensive experience in teaching nursing, coordination courses, developing curriculum, and conducting research.



She was promoted to senior lecturer rank in August 1994.

Prof. Walter W.K. King has been appointed professor of surgery from 1st September 1995.

Prof. King graduated with a BA degree from the University of Wisconsin in 1971. He furthered his studies at Vanderbilt University and obtained his MD degree in 1975. He served as an intern at Vanderbilt University Hospital for a year before joining the State University of New York at Stony Brook, first as assistant surgical resident, then as chief surgical resident and assistant clinical instructor. Between 1980 and 1984 he worked as a fellow or consultant surgeon in various well-known medical centres in the United States.

Prof. King joined The Chinese University in 1984 as lecturer in surgery, and was promoted to senior lecturer in 1988 and reader in 1993.



Prof. Walter W.K. King
Professor of Surgery

Prof. Samuel Sun Sai-ming has been appointed professor of biology from 1st December 1995.

Prof. Sun graduated with a B.Sc. degree from this university in 1966. He then furthered his studies at the University of Hong Kong and the University of Wisconsin-Madison, obtaining his M.Sc. degree in 1971 and his Ph.D. in 1974. Prof. Sun stayed at the University of Wisconsin-Madison as a postdoctoral fellow and later as an assistant scientist until 1980. He then joined the ARCO Plant Cell Research Institute, first as principal scientist, then as director. Before joining the University in December 1995, Prof. Sun taught for eight years at the University of Hawaii at Manoa and was professor in its Department of Plant Molecular Physiology.



Prof. Samuel Sun Sai-ming
Professor of Biology

NEW COUNCIL MEMBERS

The Legislative Council has elected three of its members into the University Council. They are Dr. the Hon. C.K. Law, research director of South China Brokerage Ltd. and a member of the Hong Kong Association for Democracy and People's Livelihood; the Hon. Chan Kam-lam, shipping manager of Fidelity Shipping and Agencies Ltd. and a member of the Democratic Alliance for Betterment of Hong Kong; and Dr. the Hon. John W.L. Tse, senior lecturer at the City University of Hong Kong and a member of the Democratic Party.

They will serve as members of the University Council for three years from 20th October 1995.

NEW PRO-VICE-CHANCELLOR APPOINTED



Prof. Liu Pak-wai, professor of economics, has been appointed pro-vice-chancellor of the University by the University Council for two years from 1st October 1995.

Prof. Liu graduated from Princeton University in 1971 and obtained his Ph.D. in economics from Stanford University in 1977. He joined the University as lecturer in economics in 1976, and was promoted to professor rank in 1994. He was University Registrar from 1982 to 1986, and chairman of the Economics Department from 1991 to 1995.

Apart from teaching and research, Prof. Liu has been closely involved in the formulation of major academic and administrative policies in the University.

As pro-vice-chancellor, Prof. Liu has been assigned responsibilities relating to the bursary function, the buildings office, library services, health service, and other central administrative functions.

UNIVERSITY MEMBERS HONOURED

Laurels for the Vice-Chancellor

Prof. Charles K. Kao, the vice-chancellor, was awarded the 1995 Gold Medal for Engineering Excellence by the World Federation of Engineering Organizations for his contributions to optical fibre communications. He was also conferred the first degree of service — Doctor of the University, by Griffith University of Australia in recognition of his distinguished service to international learning and university education.



In April 1996, Prof. Kao was awarded the Japan Prize by the Science and Technology Foundation of Japan. The Japan Prize honours scientists who have gained recognition for original and outstanding achievements in science and technology, thus contributing to its progress and to the peace and prosperity of mankind. Two fields of science and technology are designated for the award of the prize each year. Prof. Kao is the awardee in the field of information, computer, and communication systems.

Honorary Doctor of Humanities, Lingnan College

Prof. Jao Tsung-i, emeritus professor of Chinese language and literature, was conferred the degree of Doctor of Humanities, *honoris causa*, by Lingnan College in November 1995.

Ten Outstanding Young Persons of the World

Prof. Dennis Lam Shun-chiu, associate professor in the Department of Ophthalmology and Visual Sciences and head of the Prince of Wales Hospital's Eye Unit, was selected as one of the Ten Outstanding Young Persons of the World 1995. He was so chosen by the International Junior Chamber of Commerce for



his work in helping those suffering from poor vision. Prof. Lam, 36, has earned recognition for developing treatment and equipment for the visually impaired and helping them realize their work potential.

Officer of the Order of the British Empire

Prof. Y.M. Yeung, professor of geography and head of Shaw College, was made an Officer of the Order of the British Empire (OBE) in the Queen's New Year Honours List announced on 30th December 1995.

Badge of Honour

Mr. Lee Kam-chung, chairman of the CUHK Convocation and a member of the University Council, was awarded a Badge of Honour in the Queen's New Year Honours List.

Fellow of the Institute of Electrical and Electronics Engineers

Dr. Y.N. Hui, who joined the University in August 1995 as a visiting scholar at the Department of Information Engineering, was recently elected a Fellow of the Institute of Electrical and Electronics Engineers (IEEE) in New York.

FOUR MADE EMERITUS PROFESSORS

The University has awarded the title of emeritus professor to four retired professors — Prof. S.T. Chang, Prof. S.W. Tam, Prof. Baysung Hsu, and Prof. T.B. Lin — with effect from 29th November 1995.

Emeritus Professor of Biology

Prof. S.T. Chang has been awarded the title of Emeritus Professor of Biology. He joined the University in 1960 and was promoted to professor rank in 1978. He was chair of the Department of Biology from 1983 to 1994 and dean of science from 1975 to 1977. He also held various concurrent posts such as chair of the Science Engineering Complex Management Committee and director of the Institute of Science and Technology at different times. Prof. Chang retired on 30th September 1995.



Emeritus Professor of Chemistry

Prof. S.W. Tam has been awarded the title of Emeritus Professor of Chemistry in recognition of his distinguished services to the University as pro-vice-chancellor (1990-94), as professor of chemistry since 1982, as dean of the Graduate School (1981-93), as head of Chung Chi College for two terms, and as acting director of the School of Continuing Studies (1994-95). Prof. Tam joined the University in 1965 and retired on 31st August 1995.



Emeritus Professor of Physics

Prof. Baysung Hsu has been awarded the title of Emeritus Professor of Physics. He joined the University as professor of physics in 1964, and was dean of science for two terms — 1969-71, and 1977-79. He then served as pro-vice-chancellor for 15 years until his retirement on 30th September 1994.



Emeritus Professor of Economics

Prof. T.B. Lin has been awarded the title of Emeritus Professor of Economics. Prof. Lin joined the University in 1966 and was promoted to professor of economics in 1983. He was chair of the Department of Economics from 1975 to 1991, dean of social science from 1977 to 1980, and head of New Asia College from 1985 to 1992. He retired on 31st May 1995.





FACULTY OF MEDICINE TURNS FIFTEEN

The 1995-96 academic year marks the 15th anniversary of the Faculty of Medicine. To celebrate this special occasion, it organized a series of activities.

TV Docu-drama Series

The faculty produced jointly with RTHK a ten-episode medical docu-drama series based on actual cases at the Prince of Wales Hospital. Entitled *Tides of Life*, the series emphasizes the importance of understanding between patients and doctors, and aims at reinforcing public faith in the medical services provided by the faculty.

Filmed on location at the Prince of Wales Hospital, the series involved the participation of the hospital's doctors — and sometimes patients — who reenacted their experiences using their real names.



Commemorative Publications

Since 1992, the faculty has run a regular health education column in a local newspaper, *Ming Pao*, which educates the public on health matters relevant to the local community and informs them about medical developments.



Articles that appeared in the column were compiled into a two-volume commemorative publication entitled *Advancing Medical Frontiers*.

Another commemorative publication has adopted as its name the faculty motto *To Lead, Innovate and Serve*. It summarizes the important events in the faculty's development and its major accomplishments, and serves as an important historical record of medical education in Hong Kong.

Symposium and Renewal of Academic Exchange

In December 1995, a symposium entitled 'Innovations in Medical Education' was held to mark the renewal of academic exchange between the Beijing Medical University (BMU) and the Faculty of Medicine, and to celebrate the faculty's 15th anniversary. Prof. Wang De Bing, president of BMU, delivered a talk on 'The Challenges and Options of Medical Education in the Twenty-first Century'.

Banquet

Celebratory activities culminated in a banquet held on 10th December 1995 at the JW Marriott Hotel. Over 700 guests, including the delegation from BMU, attended the celebration.





EXCHANGE AGREEMENTS WITH MEDICAL INSTITUTIONS IN CANADA AND CHINA

The Faculty of Medicine recently signed collaboration agreements with two internationally-famous medical institutions: the Medical Faculty of the University of Alberta, Canada, and the Cancer Institute (Hospital) of Peking Union Medical College, Chinese Academy of Medical Sciences.

Medical Faculty, the University of Alberta

The agreement was signed on 7th February to provide a formal structure for existing collaboration between the two institutions.



The University of Alberta was represented by Prof. Roderick D. Fraser, president and vice-chancellor, and Prof. D. Lorne Tyrrell, dean of medicine, while CUHK was represented by Prof. Ambrose Y.C. King, acting vice-chancellor, Prof. Joseph C.K. Lee, acting dean of medicine, and Prof. Teik E. Oh, sub-dean for medical education.

The exchange programme enables senior academic staff to visit the partner institution for up to six weeks in a year to engage in teaching, research, and clinical service. It is also intended to facilitate the development of a wide range of joint academic programmes.

Established in 1908, the University of

Alberta in Edmonton has a strong medical faculty. Its programmes in basic, clinical, and public health sciences are taught by a team of nearly 400 academic staff members, many of whom have received major national and international awards for teaching and research.

The Cancer Institute (Hospital) of Peking Union Medical College, Chinese Academy of Medical Sciences

The agreement was signed on 4th March. The Cancer Institute (Hospital) was represented by Prof. Dong Zhi-wei, director of the Institute, and Prof. Cai Wei-ming of the Department of Radiation Oncology. The University was represented by Prof. Joseph C.K. Lee, acting dean of the Faculty of Medicine, and Prof. Philip J. Johnson, director of the Hong Kong Cancer Institute of the University.

The agreement provides for exchange of senior and medical staff and postgraduate students for cancer research. There will also be exchanges of academic publications on cancer, and annual meetings to be hosted by the two institutions in turn.



The Cancer Institute (Hospital) has a graduate staff of around 300 people and is closely involved in defining causes of cancers that are prevalent in China. Its specific areas of interest include the role of chemical agents in causing cancer of the oesophagus, and methods of preventing liver cancer in high-incidence areas.



NEW TREATMENT METHODS

Major breakthroughs in the treatment of intractable seizure, leukaemia, burns care, and strokes have been made by medical researchers in the University.

Intractable Seizure

Patients suffering from intractable epilepsy in Hong Kong are now offered another therapeutic option in the form of vagus nerve stimulation. A device called the vagal nerve stimulator (VNS) consisting of a small generator with three electrodes is wrapped around the vagus nerve in the patient's neck. Every five minutes a current is released to stimulate the vagus nerve. It is believed that the anti-epileptic effect of VNS, mediated through the brainstem, will slowly build up in the brain in a few months.

The Prince of Wales Hospital is the first neurosurgical centre in Southeast Asia to use the VNS. The device was recently implanted in three of its epileptic patients. All of them have shown encouraging signs of improvement after the implantation.

Leukaemia

Also for the first time in Southeast Asia, an allogeneic blood stem cell transplant was successfully carried out in April 1995 at the Lady Pao Children's Cancer Centre. Since then three leukaemic children have been treated by this method. So far none of them has shown any signs of recurrence.

Allogeneic blood stem cell transplant is the transplantation of the most primitive blood-producing cells, or blood stem cells, from a donor into a patient. Stem cells are normally found in the bone marrow, and only a few of them are present in the peripheral blood. Compared with bone marrow transplant, the collection of blood stem cells is simpler and less painful, requiring neither general anaesthesia nor hospitalization for the donor. The recipient also recovers faster and with fewer complications.

Strokes

Stroke is the third most common cause of death in developed countries and the leading cause of disability in adults. So far no drug had been found to be effective for its treatment.

The majority of strokes are caused by a blockage in the blood supply to the brain by a blood clot. Researchers at the Faculty of Medicine have now found that low-molecular-weight heparin, a new drug with greater biological activity and a better safety margin than standard heparin, can effectively prevent blood clotting. They have shown that by treating stroke patients with low-molecular-weight heparin, the likelihood of death and severe disability can be reduced by 30 per cent.

The research was undertaken jointly with four hospitals in Hong Kong. The results of the research have just been published in *The New England Journal of Medicine*, one of the world's most prestigious medical journals.

Burns Care

For the first time in Asia artificial skin made in the United States had been successfully applied to treat two adult patients with major burns at the Prince of Wales Hospital. The artificial skin, which consists of an outer silicone layer and an inner collagen dermis, is designed to provide long term coverage of burn wounds. For permanent coverage, the upper silicone layer is replaced by the patients' own thin sheet of skin graft 3 to 12 weeks later.

Previous clinical trials in the United States have found that artificial skin is a very effective skin substitute. Patients will recover faster and have less hypertrophic scarring.

MEDICAL CARE ENHANCEMENTS

Multi-disciplinary Clinic for Oesophageal Cancer Patients

A multi-disciplinary oesophageal cancer clinic was recently set up by University doctors at the Sir Y.K. Pao Centre for Cancer at the Prince of Wales Hospital.

Approximately 600 persons in Hong Kong suffer from cancer of the oesophagus every year. It is also the fifth most common cause of death due to cancer in males.

The best chance for cure is oesophagectomy, whereby the oesophagus with the tumour is surgically removed and the stomach is pulled up into the chest to perform the functions of the oesophagus. Radiotherapy can



also be used to kill tumour cells. Recently it has been found that oesophageal cancer responds to chemotherapy. The tumour may be shrunk by intravenous drugs before the operation, and then chemotherapy may be applied after the operation to kill residual tumour cells to minimize the chances of recurrence. For patients in an advanced stage of the disease, endoscopic methods such as laser therapy and insertion of oesophageal stents may be used to bore a passage through the tumour to enable swallowing.

At the oesophageal cancer clinic, patients will be seen at one sitting by specialists in oesophageal surgery, clinical oncology, and therapeutic endoscopy. A hotline (26322788) has also been set up for referrals and enquiries from patients and their relatives.

Treats to Supplement Treatment for Cancer Children

To improve the quality of life of child cancer patients, the Department of Paediatrics is teaming up with Camp Quality to launch a series of outings and recreational programmes for them and their families.



Camp Quality is an international voluntary camping and support programme for children with cancer. The aim is to allow these children to have fun and make friends like healthy children by engaging them in enjoyable and therapeutic group activities. It is hoped that memories from these occasions will help sustain them as they undergo their medical treatment. It will also bring much needed relief to the families of these children by helping them organize high quality recreational activities.

A series of visits, camping trips and outings have been planned for some 500 child cancer

patients at the Lady Pao Children's Cancer Centre and from other hospitals. Parents, doctors, nurses, volunteers, and social workers will accompany the children on all these activities.

First Wheelchair Bank for Children with Neuromuscular Diseases

The University recently received a generous donation of HK\$3 million from Cathay Pacific Airways to establish a wheelchair bank to supplement its seating clinic for children with neuromuscular diseases, which was set up at the Prince of Wales Hospital in 1994.



Children who are severely affected by muscular dystrophy, spinal muscular atrophies, and spinal bifida need to be provided with a proper seat and mobility base (for example a specially adaptable wheelchair) as soon as a diagnosis is made. The earlier this is done, the fewer the chances are of further complications and skeletal deformities like scoliosis, hip dislocations, and joint contractures. However, the majority of families with affected children cannot afford to buy proper wheelchairs or seating systems.

The wheelchairs bought for the bank will be specially designed and adaptable models with body support systems that can prevent complications as the children grow, and will allow many to take part in regular educational and other activities.

The wheelchair bank will benefit at least 200-300 children, and is unique in Southeast Asia in its concept of being a recycling bank that will maximize the use and sharing of the adaptable wheelchairs. There is also a multi-disciplinary seating clinic team to look after the fitting of the wheelchairs and the provision of regular monitoring and evaluation services.



LECTURES

Wei Lun Lectures

- Prof. Moses Chow, professor of clinical pharmacy at the University of Connecticut and director of drug information service at Hartford Hospital, delivered a lecture entitled 'Improving the Pharmacotherapy of Cardiac Arrest and Cardiopulmonary Resuscitation: A Challenge for the Present and Future' on 13th October 1995.
- Prof. Kenneth Frampton, Ware Professor of Architecture from Columbia University, presented a public lecture on 'Critical Regionalism Revisited: the Case of Iberia' on 2nd November 1995.
- Prof. René M. Stulz, Ralph Kurtz Chair in Finance from Ohio State University, gave a lecture entitled 'Does the Cost of Capital Differ Across Countries? — Cases of the US and Japan' on 21st November 1995.
- Prof. Leo P. Kadanoff, John D. MacArthur Distinguished Service Professor of Physics from the University of Chicago, delivered a lecture entitled 'Little Worlds: Investigations of Reality in Computer Models with Examples Drawn from the Physical Sciences' on 6th March 1996.
- Prof. Jerry J. Weygandt, Arthur Andersen Alumni Professor of Accountancy from the University of Wisconsin at Madison, spoke on 'Future Directions in Financial Reporting' on 11th March 1996.
- Prof. C. Warren Hollister, professor of history and medieval studies from the University of California at Santa Barbara, gave a lecture entitled 'The Decline and Fall of the Middle Ages: Reperiodizing European History' on 28th March 1996.

Professorial Inaugural Lecture

- Prof. N. M. Hjelms, professor of chemical pathology, delivered his inaugural lecture entitled 'Looking after Biomolecules' on 12th January 1996.

Li and Fung Lecture

- Prof. Harry Harding, dean of the Elliott School of International Affairs at George Washington University, gave a lecture entitled

'The Asian Challenge' at the Ritz-Carlton Hotel on 25th September 1995 as the guest speaker of the Li and Fung Lecture organized by the MBA Programmes of the University.

CONFERENCES/SYMPOSIA/ WORKSHOPS

- The Faculty of Business Administration organized an intensive workshop on behavioural business research from 5th to 7th September 1995.
- The University's Chinese Law Programme and the French Centre on Contemporary China in Hong Kong jointly organized the Symposium on Centralization and Regionalism: Social and Legal Re-composition in China and Europe from 22nd to 23rd September 1995.
- The University organized/co-hosted the following functions:
 - A World Health Organization training course on the prevention, treatment, and rehabilitation of drug abuse from 11th to 20th December 1995.
 - A symposium on the Hong Kong Science Park on 14th December 1995.
 - A sexual harassment workshop from 15th to 17th January 1996. Prof. Margaret L. Andersen, professor of sociology and women's studies and Vice-Provost for Academic Affairs at the University of Delaware, was invited to conduct the workshop and delivered a lecture entitled 'Sexual Harassment: Purely Academic?' on 16th January.
- Chung Chi College coorganized the following conferences:
 - 'The Seventh International Conference on the Cognitive Processing of Chinese and Other Asian Languages', along with the Department of Psychology from 14th to 16th December 1995.
 - 'The International Conference on Elderly Care, the Family, and Human Values in the Twenty-first Century', along with the Hong Kong Baptist University and the Hong Kong University of Science and Technology from 8th to 10th February 1996.

- The Programme for Hong Kong Cultural Studies of the Research Institute for the Humanities organized an international symposium on 'Cultural Politics of Cosmopolitanism: Critiques of Modernity in the Non-Western Contexts' from 4th to 6th January 1996.
- The University's Department of Curriculum and Instruction, the Hong Kong Association for Science and Mathematics Education, and the Mathematics, Science and Computer Education Unit of the Curriculum Development Institute jointly organized a seminar on resources for enhancing effective learning of physics in the sixth form on 6th January 1996.
- The University's Department of Surgery hosted the second Asian Pacific Burns Conference from 9th to 11th February 1996 at the Hong Kong Convention and Exhibition Centre. The conference was co-sponsored by the World Health Organization, the International Society for Burns Injuries, the Japanese Society for Burns Injuries, the Health Department, the Hospital Authority, the Hong Kong Burns Society, and the Burns Foundation.
- The University's Hong Kong Cancer Institute hosted the first annual symposium on EBV-related tumours on 4th March 1996. That was one of the events to celebrate the first anniversary of the Sir Y.K. Pao Centre for Cancer and the Lady Pao Children's Cancer Centre at the Prince of Wales Hospital.
- Prof. Akin Mabogunje, chairman of the First Interstate Merchant Bank (Nigeria) Limited and Nigeria's Development Policy Centre in Ibadan, visited Shaw College as its 1996 Sir Run Run Shaw Distinguished Visiting Scholar from 11th to 20th January 1996. Prof. Mabogunje delivered a public lecture entitled 'Africa in the Twenty-first Century: Challenges of the Last Investment Frontier' on 17th January.

NEW POSTGRADUATE PROGRAMMES



The University Senate has endorsed the introduction of five new postgraduate programmes in 1996-97:

- Doctor of Philosophy Programme in Architecture
- Doctor of Philosophy Programme in Nursing
- Master of Philosophy Programme in Pharmacy
- Master of Science Programme in Finance
- Master of Social Science Programme in Communication

ACADEMIC COMMITTEE RENAMED

The Committee on French, German and Italian Studies has been renamed Committee on European Languages. The new name accommodates the new elective courses in Spanish introduced in 1995-96 and is more succinct.

VISITING SCHOLARS

- Prof. Jean-Marie Lehn, 1987 Nobel Laureate in chemistry, visited the Department of Chemistry in December 1995 as its Advanced Chemicals Limited Distinguished Visiting Professor. During his visit, he conducted a public lecture entitled 'From Matter to Life: Chemistry?!' on 14th December, and spoke at a research seminar on 'Supramolecular Chemistry: Concepts and Perspectives' on 15th December.

DIPLOMA PROGRAMME RENAMED

The 'Diploma in Education' awarded by the University will be renamed 'Postgraduate Diploma in Education' with effect from the 1996-97 intake.



ART EXHIBITIONS

Art Museum Exhibitions

The Art Museum organized four exhibitions between September 1995 and May 1996:

- 'Modern Paintings of Guangdong Artists' was held at the Osaka Municipal Museum of Art from 29th September to 26th November 1995.

The exhibition featured 42 paintings by Gao Jianfu, and 23 other pieces of work by three generations of 'Lingnan painters': Ju Chao and Ju Lian, Gao Qifeng and Gao Jianseng, and Zhao Shao'ang and Guan Shanyue. These masterpieces reveal the transition, evolution and creativities of the influential Lingnan school of painting.

The exhibition was jointly sponsored by the Hong Kong Economic and Trade Office and the Osaka Municipal Museum of Art under the 'Hong Kong-Japan Partnership' programme.

- 'Selections from the Art Museum Collection' has been staged at the east-wing galleries of the museum from 14th October 1995.

Selected from the Art Museum collection, a variety of art forms were featured to represent the heritage of Chinese culture. There were ceramics, tomb bricks, stone steles, as well as paintings and rubbings, ranging from the Han to the Qing dynasties.

- 'The World of Wong Po-yeh' was staged at the west-wing galleries of the museum from 21st October 1995 to 11th February 1996.

Over 100 paintings by Wong Po-yeh (Huang Bore, 1901–1968) were exhibited. About 70 late-year paintings by the artist, presenting Hong Kong landscapes of the 1950s and 1960s with simple and spontaneous strokes with brush and ink, formed the core of the exhibition. Also included were some 50 paintings of traditional theme and sketches.



Wong Po-yeh *Tsim Sha Tsui*

- 'The Cheng Xun Tang Collection of Painting and Calligraphy on Fans' was staged at the west-wing galleries of the museum from 9th March to 19th May 1996.

The fan as a purely functional object has had a long history in China. The combination of painting and calligraphy with traditional fan crafting techniques produced a new art form. The folding fan in particular has aesthetic elements that are uniquely its own: its shape, material and folds are both inspiring and challenging to artists. During the Ming and Qing dynasties, the popularity of decorated fans enriched the development of painting and calligraphy.

Some 180 pieces of fans by 160 artists of the Ming and Qing periods were exhibited. The Art

Museum also published a fully illustrated 400-page catalogue of the exhibition, and organized lectures and a demonstration to accompany the function.



Wang Yuanqi *Landscape after Wang Meng*



Recent Works by Teaching Staff of the Department of Fine Arts

An exhibition of recent works by teaching staff of the University's Department of Fine Arts was staged at Hui's Gallery, New Asia College, from 18th November to 16th December 1995.



Ink and Colour — Joint Exhibition by Six Artists

Works of art by six fine arts students were exhibited from 3rd to 16th February 1996 in the Exhibition Hall of the Shaw College Theatre.

The Third Chinese University Staff Joint Art Exhibition

The exhibition was presented by Sir Run Run Shaw Hall from 18th to 29th March. On display were sketches, painting, Chinese calligraphy, photography, and ceramics produced by 28 staff members from different units.



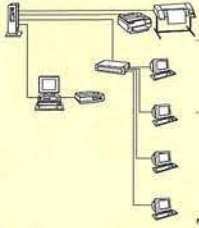

CONSORTIUM FOUNDED TO PROMOTE ELECTRONIC INFORMATION SERVICES IN HONG KONG

To encourage the development of electronic information services in Hong Kong, the University took the initiative to set up an Electronic News Media and Publishing Consortium (ENMPC) in October 1995. Sponsored by the Industry Department, this non-profit-making consortium serves as a platform for the local news media and publishing industry to test electronic information delivery, retrieval and library services. It also provides a forum for the discussion of technical, cultural and social issues pertaining to the development of electronic information services. Among its founding members are prominent local news organizations.

All Hong Kong-registered organizations and institutions can join ENMPC as full members while those not registered in Hong Kong can join as associate members. All hardware and software platforms of ENMPC are maintained by the University's Department of Information Engineering.

SCHOOL OF ACCOUNTANCY LAUNCHED NEW INITIATIVES

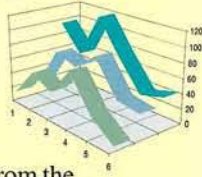

Visit to Beijing and Shanghai

Thirty-two students and four lecturers from the School of Accountancy undertook a study tour to Beijing and Shanghai from 28th December 1995 to 5th January 1996. In Beijing they visited the Renmin University of China, Tsinghua University, Capital Steel Company, and the Bank of China where they were briefed on banking reforms in the country. In Shanghai they attended seminars on China's accounting reform and development arranged by the Shanghai University of Finance and Economics. They also visited the city's stock exchange and the Pudong economic development zones.

During the trip, the teachers discussed accounting and tax law issues with experts of the Commission on Legislative Affairs of the Standing Committee of the National People's Congress. They also explored possibilities of academic exchange and collaboration with their counterparts from the universities they visited.

The tour was made possible by the assistance and sponsorship from the New China News Agency (Hong Kong Branch), Deloitte Touche Tohmatsu, and Sun Life of Canada.

Formation of CU Accounting Link

The School of Accountancy recently set up the CU Accounting Link to foster the school's interaction with its alumni, as well as with other members in the accounting profession and supporters in the business field. Potential members of the Link include approximately 2,000 accounting graduates, some 200 holders of the diploma in accounting for managers, non-accounting graduates of the University currently working in the field of accounting, former staff of the school, and friends from the industry and the accounting profession.

It is hoped that through this network, members will be regularly informed of the developments in accounting education at the University and in Hong Kong. They will also have a new channel through which to advise and support the school.

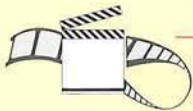

HK\$4.9 MILLION FOR CU PRESS TO DEVELOP TEACHING KITS

The Chinese University Press recently won two contracts worth a total of HK\$4.9 million to design and produce teaching kits for local primary schools.

China Light and Hong Kong Electric have invited The Press to produce materials on environmental protection and energy conservation to be used for teaching general studies to pupils from primary four to six.

Prof. Teresa Siu, associate professor in the Department of Curriculum and Instruction, will design the instructional strategies in collaboration with her counterpart from the Hong Kong Education Department, while The Chinese University Press will design and produce video programmes, audio programmes, and simulation games. The target completion date is September 1996.

The University has recently received from local and overseas individuals and foundations the following

Gifts and Donations

in support of its programmes and projects:

1. From Allied Domecq Spirits & Wine (Overseas) Ltd. (previously known as Hiram Walker Wines & Spirits Ltd.) HK\$10,000 to provide an exchange student award for a second-year student of the Two-Year MBA Programme in 1995-96.
2. From The American Chamber of Commerce in Hong Kong HK\$23,000 annually to provide an award for a student of the Three-Year MBA Programme.
3. From AST Asia HK\$10,000 annually to provide two scholarships of \$5,000 each for final-year students, one each from the Faculty of Business Administration and the Department of Computer Science and Engineering.
4. From The Croucher Foundation:
 - a. HK\$330,000 to set up a fund for needy students in 1995-96; and
 - b. HK\$600,000 to support academic visits by scholars from mainland China to the University in 1995-96.
5. From Hong Kong Society of Accountants HK\$7,000 annually to provide a scholarship for a final-year student of the Faculty of Business Administration.
6. From Miss Leung Pui Han Scholarship Fund HK\$60,000 to provide a number of bursaries for needy students in 1995-96.
7. From Li Po Chun Charitable Trust Fund Committee:
 - a. HK\$48,000 to provide two scholarships of \$24,000 each for full-time postgraduate students in 1995-96; and
 - b. HK\$200,000 to provide 10 scholarships of \$20,000 each for full-time undergraduate students in 1995-96.
8. From Mr. Lo Siu-tong HK\$25,000 to provide two scholarships of \$12,500 each for students of the Department of Architecture and the Department of English in 1995-96.
9. From Pharmacia Asia Ltd. HK\$1,000 to provide a prize in clinical oncology for an outstanding medical student in 1994-95.
10. From Shun Yip Textiles Ltd. HK\$5,000 to provide a bursary for a needy student in 1995-96.
11. From Sik Sik Yuen HK\$60,000 annually to provide three scholarships for outstanding students of the Faculty of Education.
12. From Television Broadcasts Ltd. HK\$10,000 annually to provide a scholarship for a postgraduate student in communication.
13. From Tsim Sha Tsui District Kai Fong Welfare Association:
 - a. HK\$10,000 to set up a bursary fund in 1995-96 for needy students; and
 - b. HK\$200,000 to establish an endowment fund to provide bursaries for needy students from 1996-97 onwards.
14. From Università per Stranieri di Siena ITL1,400,000 to provide two awards of ITL700,000 each for students who are studying Italian to attend a summer course at the Università in 1995.
15. From The Wah Kiu Yat Po Fund for the Relief of Underprivileged Children:
 - a. HK\$15,000 annually to provide a scholarship for an outstanding postgraduate student of communication; and
 - b. HK\$60,000 annually to provide four scholarships for outstanding undergraduate students of journalism and communication.
16. From Younger Managers' Club HK\$17,000 to provide two scholarships for second-year students of the Two-Year MBA Programme to participate in the club's August 1995 study tour to China.
17. From Ms. Annie Cheng HK\$1,200 to support the publication work of the Alumni Affairs Office.
18. From Duty Free Shoppers Charitable Trust HK\$20,000 to sponsor the printing cost of a booklet on menopause published by the Department of Community and Family Medicine.
19. From The Henry Luce Foundation Inc. US\$23,000 to sponsor the publication of a series of archives of pre-1949 China Christian colleges undertaken by Prof. Peter T.M. Ng of the Department of Religion and Prof. Leung Yuen-sang of the Department of History.
20. From Medisport Limited HK\$7,000 to sponsor the printing cost of the course manual on hand rehabilitation of the Chinese conducted by the Department of Orthopaedics and Traumatology.
21. From Shih Wing Ching Foundation Limited HK\$40,000 to sponsor the sequel publication of the proceedings of the second international conference on Chinese paleography undertaken by the Department of Chinese Language and Literature.

22. From Abbott Laboratories Limited HK\$42,183 to support the maternal study on prenatal diagnosis undertaken by the Department of Obstetrics and Gynaecology.
23. From the following donors to the Hong Kong Cancer Institute for research purposes:
 - a. an anonymous donor HK\$200;
 - b. Ms. Chan Nga-sze, Grace HK\$100;
 - c. Miss Ching Hok-ying, Ruby HK\$1,000;
 - d. Miss Kam Wai-fong HK\$20; and
 - e. Mr. Wong To HK\$1,000.
24. From Armedic Far East Limited to the Department of Medicine:
 - a. HK\$100,000 to support a clinical study on anti-hypertensive therapy in Hong Kong; and
 - b. HK\$10,000 to support an international symposium on myocardial infarction held in March 1995.
25. From Bayer China Co. Ltd.:
 - a. HK\$117,900 to support a clinical trial undertaken by the Department of Medicine; and
 - b. HK\$5,000 to sponsor a staff member of the Department of Surgery to attend the annual scientific meeting of the Royal Australasian College of Surgeons in Perth, Australia, in May 1995.
26. From Mr. Chang Chun-kit HK\$5,000 to support the research project on atherosclerosis in the Chinese undertaken by the Department of Medicine.
27. From Chiang Ching Kuo Foundation for International Scholarly Exchange TWD600,000 as the final instalment of the donation to support the research project on a computerized database of the entire body of extant Wei-Jin and the Northern & Southern dynasties traditional Chinese texts undertaken by the Institute of Chinese Studies.
28. From Glaxo Hong Kong Limited HK\$243,950 to support a clinical trial undertaken by the Department of Medicine.
29. From Hong Kong Telecom Foundation HK\$400,000 as the final instalment of the 1994 grant for the applied research projects undertaken by the Faculty of Engineering.
30. From Mrs. Kadoorie Betty HK\$10,000 to the Department of Surgery for research purposes.
31. From Kellogg (Aust) Pty. Ltd. US\$5,000 to support the Asia-Pacific Regional Urban Adult Dietary Survey undertaken by the Department of Paediatrics.
32. From the following donors to support the research project on the enhancement of diabetic care and research activities in Hong Kong undertaken by the Department of Medicine:
 - a. Mr. Lam Chung-hong HK\$690; and
 - b. Mr. Pang Chi-wang HK\$100.
33. From the following donors to the Neurosurgery Unit of the Department of Surgery for research purposes:
 - a. Lee Cheong Gold Dealers Ltd. HK\$50,000; and
 - b. Wah Cheong Silk Ltd. HK\$100,000.
34. From Mrs. Nancy Lee HK\$1,100 to support the project on research utilization in education and social sciences undertaken by Prof. C.Y. To.
35. From Prof. Leung Sing-fai HK\$831 to the Department of Clinical Oncology for research purposes.
36. From Merck Sharp & Dohme (Asia) Limited US\$15,000 to support a research study undertaken by the Department of Clinical Pharmacology.
37. From Milupa HK\$20,000 to support the study on fatty acid profile of human milk undertaken by the Department of Paediatrics.
38. From Oriental Press Charitable Fund Association:
 - a. to the Department of Medicine HK\$920 to support the Hong Kong Lupus Nephritis Study; and
 - b. to the Department of Surgery
 - i. HK\$1,870 to support the Skin Bank; and
 - ii. HK\$19,990 towards the Burns Foundation.
39. From Parke Davis Pharmaceutical Research HK\$141,481 to support a research project on epidermal growth factor undertaken by the Department of Paediatrics.
40. From Pfizer Corporation HK\$20,000 to support the epidemiological study of dementia and depression in the elderly in Hong Kong undertaken by the Department of Psychiatry.
41. From Warner Lambert (HK) Ltd. to the Department of Psychiatry:
 - a. HK\$35,000 to support the epidemiological study of dementia and depression in the elderly in Hong Kong; and
 - b. HK\$80,000 to support the study of tarcine in patients with Alzheimer's disease.
42. From Roche Pharmaceuticals and Chemicals Ltd.:
 - a. HK\$201,090 to support clinical trials undertaken by the Department of Medicine; and
 - b. HK\$10,000 to sponsor a staff member of the Department of Paediatrics to attend a meeting on marrow transplantation in children in South Carolina, USA, in June 1995.
43. From The Royal College of Pathologists of Australasia HK\$22,283.20 to support the study on the use of cytology for the detection of nasopharyngeal carcinoma undertaken by the

- Department of Anatomical and Cellular Pathology.
44. From Sandoz Pharmaceuticals Limited:
 - a. to the Department of Medicine
 - i. AUD15,000 to support the research project on the identification of the role of genetic and environmental factors in Parkinson's disease in Chinese population;
 - ii. HK\$15,000 to support the research project on neural conversion trial in stable renal transplant patients;
 - b. to the Department of Paediatrics HK\$5,479.50 to sponsor a staff member to attend a meeting of the International Society of Paediatric Oncology in Paris, France, in September 1994;
 - c. to the Department of Surgery HK\$15,000 to sponsor a staff member to attend the annual international congress of the British Association of Paediatric Surgeons held in the UK in July 1995; and
 - d. to the Department of Clinical Oncology HK\$8,000 to sponsor a staff member to attend the International Congress of Chemotherapy in Montreal, Canada, in July 1995.
 45. From Sankyo Co. Ltd. HK\$150,000 to support the *in vitro* sensitivity test on cefmetazole and cefpodoxime proxetil undertaken by the Department of Microbiology.
 46. From Dr. Jonas Singer US\$50 to the ENT Unit of the Department of Surgery for research purposes.
 47. From SmithKline Beecham Limited to the Department of Psychiatry:
 - a. HK\$50,000 to support a research study on epidemiology; and
 - b. HK\$15,000 to sponsor a staff member to attend a scientific meeting of the Pacific Rim College of Psychiatrists in Fukuoka, Japan, in October 1995.
 48. From The Society for the Relief of Disabled Children HK\$75,000 to support the research project on nutritional rehabilitation of disabled children with feeding difficulties undertaken by the Department of Paediatrics.
 49. From The American Women's Association of Hong Kong Ltd. a further donation of HK\$10,000 towards a student loan fund for female students in financial need.
 50. From Amway Asia Pacific Ltd. HK\$12,000 to support the nutrition-related academic activities undertaken by the Department of Paediatrics.
 51. From the following donors to support the international conference on Chinese architectural history organized by the University's Department of Architecture in August 1995:
 - a. Architectural Services Department of the Hong Kong Government HK\$5,000; and
 - b. The Lord Wilson Heritage Trust HK\$100,000.
 52. From Astra Pharmaceuticals (HK) Limited HK\$36,000 to sponsor a staff member of the Department of Surgery to attend the Ibero-American Congress of Otoneurology in Barcelona, Spain, in June 1995.
 53. From Bei Shan Tang Foundation Limited:
 - a. HK\$20,354 to support the conference on scientific data and art historical analysis of Shiwan pottery organized by the Yeung Shui Sang Laboratory for Thermoluminescence of Ancient Ceramics in June 1995; and
 - b. HK\$30,480 to sponsor the travelling expenses of a staff member each of Nanjing Museum, Asian Art Museum in San Francisco, and the University's Art Museum to visit museums and meet experts in Yixing wares in Nanjing, Yixing, Wuxi, Suzhou and Shanghai in August 1995.
 54. From Boehringer Ingelheim (HK) Limited HK\$19,000 to sponsor a staff member of the Department of Medicine to attend the Asian Pacific Congress of Cardiology in Bali, Indonesia, in September 1995.
 55. From Celki Medical Co. HK\$19,500 to sponsor a staff member of the Department of Psychiatry to attend a conference on sleep in USA in June 1995.
 56. From the following donors to support the development of pathology in China undertaken by the Department of Anatomical and Cellular Pathology:
 - a. Dr. Choi Chung-ho, Andrew HK\$1,000;
 - b. Dr. Chow Tsun-cheung HK\$500;
 - c. Dr. Lam Woon-yeek HK\$200;
 - d. Prof. C.K. Lee, Joseph HK\$500;
 - e. Dr. Ma Tung Lily HK\$500;
 - f. Dr. Mak Wai-ping HK\$1,000;
 - g. Prof. Ng Ho-keung HK\$1,000; and
 - h. Prof. Suen Wang-ming HK\$500.
 57. From the following donors towards The Hong Kong Paediatric Bone Marrow Transplant Fund of the Department of Paediatrics:
 - a. Mr. Chung Cheuk-kay HK\$1,000;
 - b. Mr. Pau Kit-kwan HK\$20,000; and
 - c. Ms. To Fung-chu, Ammy HK\$20,000.
 58. From Ciba-Geigy (Hong Kong) Limited HK\$4,000 to sponsor a staff member of the Department of Anaesthesia and Intensive Care to attend the South and East Asia Conference on Emergency Medical Care in Singapore in August 1995.
 59. From CUHK Convocation HK\$400,000 to the Department of Music for installing professional sound equipment.

60. From Eli Lilly Asia Inc. HK\$30,000 to sponsor two staff members of the Department of Psychiatry to attend the international conference held in Dublin, Ireland, in August 1995 and in Budapest, Hungary, in October 1995.
61. From Friends of the Art Museum HK\$24,000 to support a summer work-study programme undertaken by the Art Museum.
62. From Gambro China Limited HK\$9,000 to sponsor a staff member of the Department of Medicine to attend the annual conference and exposition of the American Society for Artificial Internal Organs in Chicago, USA, in May 1995.
63. From General Medical Ltd. HK\$24,453 to sponsor a staff member of the Department of Surgery to attend the International Neurotrauma Symposium in Toronto, Canada, in July 1995.
64. From The Hong Kong Cancer Fund HK\$330,060 to sponsor the appointment of a research associate in the Department of Clinical Oncology for one year from April 1995.
65. From Hong Kong Pei Hua Education Foundation Limited HK\$25,000 to support the mathematics conferences organized by Prof. S.T. Yau of the Institute of Mathematical Sciences.
66. From Lee Hysan Foundation Limited:
 - a. HK\$75,000 to support the mathematics conferences organized by Prof. S.T. Yau of the Institute of Mathematical Sciences; and
 - b. a further donation of HK\$410,000 to support a series of workshops on Open Chemistry Laboratory organized by the Department of Chemistry.
67. From Howmedica Far East US\$3,677 to sponsor a staff member of the Department of Orthopaedics and Traumatology to attend the Vienna Exeter Meeting in Austria and London, UK, in April and May 1995.
68. From Inchcape JDH Ltd.:
 - a. HK\$4,000 to sponsor a staff member of the Department of Orthopaedics and Traumatology to attend the congress of the International Federation of Societies for Surgery of the Hand in Helsinki, Finland, in July 1995; and
 - b. HK\$5,000 to support a rehabilitation programme undertaken by the Department of Psychiatry.
69. From International Enuresis Research Center HK\$13,560 to sponsor a staff member of the Department of Surgery to attend a workshop organized by the donor in Aarhus, Denmark, in May 1995.
70. From Johnson & Johnson Medical Hong Kong:
 - a. HK\$25,000 to sponsor a symposium on laparoscopic colposuspension and pelvic floor organized by the Department of Obstetrics and Gynaecology in May 1995; and
 - b. HK\$5,000 to support a seminar on common surgical problems in children organized by the Department of Surgery in June 1995.
71. From Kiangsu & Chekiang Residents (HK) Association HK\$16,000 to provide a number of interest-free loans for students with unforeseen financial difficulties in 1994-95.
72. From Dr. Alice K. Y. Lam HK\$33,000 to support the Round-the-CU Walkathon organized by the Alumni Affairs Office in March 1995.
73. From Lippo Group a further donation of HK\$100,000 to support the research programme on urban and regional development in Pacific Asia organized by the Hong Kong Institute of Asia-Pacific Studies.
74. From Mekim Limited to the Department of Surgery:
 - a. HK\$30,000 to sponsor a staff member to attend the 1995 Combined Scientific Meeting in Gold Coast, Australia, in June 1995; and
 - b. a donation to sponsor the accommodation of a staff member attending a lecturing tour in Beijing in May 1995.
75. From Nestle China Ltd. HK\$10,000 to the Department of Paediatrics for reproducing the 1993 Growth Survey.
76. From Otsuka Pharmaceutical Co. Ltd. HK\$15,000 to sponsor a staff member of the Department of Surgery to attend the congress of the Asian Federation of Coloproctology in Seoul, Korea, in June 1995.
77. From the following donors to sponsor the 1995 Quentin Pan Lectures organized by the Department of Anthropology in Beijing in October 1995:
 - a. Dr. Francis K. Pan HK\$42,000;
 - b. Dr. Shirley N. Pan HK\$42,000;
 - c. Tele-Art Ltd. HK\$42,000; and
 - d. Mr. Robert Yuen HK\$42,000.
78. From Resound Limited HK\$12,000 to support the General Practitioner Update Course organized by the Department of Surgery in May 1995.
79. From Sino-British Fellowship Trust for 1994-95:
 - a. GBP1,500 towards the vice-chancellor's discretionary fund; and
 - b. GBP10,000 to support academic exchanges with institutions in China.
80. From SOL Ltd. HK\$15,000 to sponsor a staff member of the Department of Medicine to attend the Asian Pacific Congress of Allergology and Clinical Immunology in Taiwan in November 1995.

81. From Soma International Ltd. HK\$40,000 to provide a number of loans for needy students in 1995–96.
82. From Swire Loxley Ltd. HK\$50,000 to support the Diabetes Centre of the Department of Medicine.
83. From United Board for Christian Higher Education in Asia US\$18,000 to sponsor Mr. Ma Yun-peng of Northeast Normal University and Mr. Zhu Xin-hua of Hangzhou University to visit the University's Faculty of Education in 1995.
84. From various donors gifts and donations totalling HK\$1,126,310.01 to Chung Chi College from November 1994 to April 1995.
85. From various donors HK\$202,040.30 to support the Burns Charity Event organized by the Department of Surgery.
86. From various donors HK\$8,322.16 towards The Chinese University of Hong Kong Alumni Fund.
87. From Wong Chen Associates Ltd. HK\$2,000 to support the student orientation camp of the Department of Architecture.
88. From K.C. Wong Education Foundation HK\$15,000 to sponsor a staff member of the Department of Anatomy to join a lecturing tour of the medical universities in Shanghai in May 1995.
89. From Woo Chow Wong and Partners (HK) Ltd. HK\$1,000 to support the student activities of the Department of Architecture.
90. From Mr. Anthony Y.C. Yeh HK\$1,000,000 to the United College for general purposes.
91. From Yuen Yuen Institute HK\$30,000 to sponsor six scholars from Beijing to visit the University in August 1995 and do the editorial work of the Chinese classics project undertaken by Prof. C.Y. To.
92. From The Industrial Promoting Co. Ltd. a donation covering the air-ticket, registration fees and accommodation of a staff member of the Department of Surgery attending the annual meeting of the American Society of Laser Medicine and Surgery in San Diego, USA, in April 1995.
93. From The Japan Foundation a donation of reference materials on Japanese studies to the University.
94. From Sanofi Winthrop H.K. Ltd. a donation covering the air-ticket, registration fees and accommodation of a staff member of the Department of Surgery attending the world congress of the International Union of Angiology in London, UK, in April 1995.
95. From Schering-Plough a donation covering the air-ticket and accommodation of a staff member of the Department of Surgery attending the Round Table Discussion Meeting in Thailand in June 1995.
96. From Silicon Graphics Limited the donation of a World-wide Web server to the Computer Services Centre.
97. From Lee Hysan Foundation Limited HK\$28,000,000 to support the concert hall project in the phase V redevelopment of teaching buildings at Chung Chi College.
98. From American International Assurance Foundation Limited a donation to provide two tuition-free scholarships for outstanding final-year students in 1995–96.
99. From Australian Society of Certified Practising Accountants HK\$4,000 annually to provide a prize for a final-year student of professional accountancy.
100. From Bank of China Group HK\$150,000 annually for five years to provide 10 scholarships of \$15,000 each, seven for undergraduate students and three for postgraduate students of business administration.
101. From Cable TV HK\$10,000 annually for three years to provide a scholarship for an outstanding student of journalism and communication.
102. From Chinese General Chamber of Commerce (Foundation) Limited annually for five years:
 - a. HK\$60,000 to provide six scholarships for outstanding students of the Faculty of Business Administration, the Department of Economics and the Department of Information Engineering; and
 - b. HK\$140,000 to provide a number of bursaries for outstanding students with financial difficulties.
103. From The Chinese Gold & Silver Exchange Society a further donation of HK\$43,000 towards an endowment fund, the annual income from which will provide a scholarship for a full-time postgraduate student from 1996-97 onwards.
104. From Coopers & Lybrand HK\$30,750 annually to provide a scholarship for an outstanding student of professional accountancy.
105. From Ernst & Young HK\$30,000 annually to provide a scholarship for an outstanding student of professional accountancy.
106. From the external examiners of the Faculty of Medicine HK\$1,200 to provide a prize for a medical student.
107. From Exxon Chemical International-Asia Ltd. and Exxon Energy Ltd. HK\$30,750 to provide a scholarship for an outstanding Two-Year MBA Programme student.
108. From Mr. Edward S.T. Ho HK\$3,000 annually to provide a prize for an outstanding final-year student of the Department of Fine Arts.
109. From Hong Kong College of General Practitioners HK\$2,000 annually to provide a prize in family medicine for an outstanding medical student.

110. From The Hong Kong Federation of Insurers Educational Trust HK\$20,000 to provide a scholarship for an outstanding final-year business administration student majoring in either finance or marketing.
111. From The Hong Kong Institute of Company Secretaries HK\$3,000 annually to provide three prizes for outstanding students of business administration.
112. From Hong Kong Institute of Marketing HK\$5,000 annually to provide a scholarship for an outstanding student of marketing.
113. From Hong Kong Telecom Foundation annually for four years:
 - a. HK\$30,750 to provide a scholarship for a postgraduate student; and
 - b. a donation of an amount equivalent to tuition fee plus an allowance of HK\$20,000 and one round trip economy class airfare to/from Hong Kong for a postgraduate student from mainland China.
114. From Jackie Chan Charitable Foundation HK\$15,000 to provide two scholarships for outstanding students of music.
115. From Kowloon Chamber of Commerce for 1995–96:
 - a. HK\$30,000 to provide three scholarships of \$10,000 each for an outstanding student of Chinese language and literature, of economics, and of social work; and
 - b. HK\$30,000 to provide six bursaries of \$5,000 each for outstanding students with financial difficulties.
116. From LeaRonald (S.E. Asia) Ltd. HK\$3,000 annually to provide a scholarship for a final-year student of chemistry.
117. From M.C. Packaging (Hong Kong) Ltd. HK\$6,000 annually to provide a scholarship for an outstanding final-year student of, on a rotation basis, the faculties of business administration, engineering, science, and social science.
118. From Mobil Oil Hong Kong Ltd. HK\$17,000 annually to provide a scholarship for an outstanding student of the Faculty of Engineering.
119. From The Nanyang Commercial Bank Ltd. HK\$10,000 annually for three years to provide a prize for the top graduate in economics.
120. From The Orient Overseas Container Line Ltd. for 1995–96:
 - a. HK\$60,000 to provide travel awards of up to \$10,000 each to subsidize undergraduate students attending overseas conferences or conducting study-travel projects; and
 - b. HK\$240,000 to provide six scholarships of \$40,000 each for outstanding students of the faculties of arts, business administration, engineering, science, and social science.
121. From Procter & Gamble Hong Kong Limited HK\$30,750 annually to provide a scholarship for a second-year student of the Two-Year MBA Programme.
122. From Sharp-Roxy (Hong Kong) Limited HK\$10,000 to provide a scholarship for an outstanding student of electronic engineering in 1995–96.
123. From South China Morning Post Publishers Limited HK\$40,000 annually to provide four scholarships for outstanding students of journalism and communication.
124. From Standard Chartered Community Foundation (previously known as Standard Chartered Bank) HK\$61,500 annually to provide two scholarships for outstanding students of business administration.
125. From Star TV HK\$6,000 annually to provide two scholarships of \$3,000 each for outstanding students of journalism and communication.
126. From The Swatow Lodge No.3705 EC HK\$20,000 to provide two bursaries of \$10,000 each for needy students in 1995–96.
127. From K.P. Tin Foundation Ltd. HK\$40,000 annually to provide five educational research assistantships for outstanding students of the Faculty of Education.
128. From S.K. Yee Medical Foundation HK\$110,000 annually to provide 11 scholarships for outstanding medical students.
129. From Chiang Ching Kuo Foundation for International Scholarly Exchange:
 - a. to the Research Centre for Translation US\$5,646.09 as the first instalment of a donation to support the publication of *Modern Times*;
 - b. to the Department of Anthropology
 - i. US\$5,297.85 as the first instalment of a donation to support the publication of *Taiwan Studies: A Journal of Translation* conducted by Prof. Joseph Bosco;
 - ii. US\$10,628.50 as the first instalment of a donation to support a research project on food culture in Taiwan undertaken by Prof. David Wu;
 - iii. a further donation of US\$9,793.28 to support a research project on the Mazu Temple undertaken by Prof. Joseph Bosco;
 - c. to the Department of Architecture US\$7,769.42 as the first instalment of a donation to support a research project on the oral architectural history of China undertaken by Prof. Tunney Lee;
 - d. to the Department of History
 - i. US\$10,362.66 to support a research project on private correspondence of

- Sheng Hsuan-huai undertaken by Prof. N.H. Lun Ng;
- ii. US\$8,392.95 as the first instalment of a donation to support a research project on the legitimization of new orders undertaken by Prof. Leung Yuen-sang;
 - e. a further donation of US\$13,612.53 to support a research project on traditional musicians in Shanxi undertaken by Prof. Chiao Chien;
 - f. to the Department of Music a further donation of US\$10,809.11 to support a comparative study of Taoist music undertaken by Prof. Tsao Pen-yeh; and
 - g. US\$20,749.91 as the first instalment of a donation to support the conference on the application of social sciences and Chinese modernization organized by Prof. Rance Lee to be held in Hong Kong and Taiwan in June 1996.
130. From Action Committee Against Narcotics HK\$60,000 to support a research project on drugs abuse undertaken by the Department of Psychiatry.
 131. From an anonymous donor HK\$5,000 to support an epidemiological study on dementia and depression in the elderly in Hong Kong undertaken by the Department of Psychiatry.
 132. From Warner Lambert (HK) Ltd.:
 - a. HK\$35,000 to support an epidemiological study on dementia and depression in the elderly in Hong Kong undertaken by the Department of Psychiatry; and
 - b. HK\$5,000 to sponsor a staff member of the Department of Medicine to attend an international symposium on drugs affecting lipid metabolism in Houston, USA, in November 1995.
 133. From Bayer China Co. Ltd.:
 - a. HK\$50,000 to support a clinical study on prevention of stent blockage by oral ciprofloxacin undertaken by the Department of Medicine; and
 - b. HK\$20,000 to sponsor two staff members of the Department of Clinical Pharmacology to attend the Pacific Rim Hypertension Conference in Tokyo, Japan, in October 1995.
 134. From the following donors to support the project on the enhancement of diabetic care in Hong Kong and research on diabetes:
 - a. Miss Chan Mei-hang HK\$500;
 - b. Mr. Lam Hing-ming HK\$500;
 - c. Miss Lung Yee-ha, Rosa HK\$500;
 - d. Mr. Yeung Lee-bun HK\$200; and
 - e. Mr. Yim Wah HK\$300.
 135. From Thomas H.C. Cheung Foundation Ltd. HK\$20,000 towards the Convocation Research Programme Fund.
 136. From Prof. Sydney S.C. Chung GBP400 to the Department of Surgery for research and teaching purposes.
 137. From The Croucher Foundation:
 - a. HK\$188,000 to support a research project on wavelength-multiplexing using self-injection locked lasers undertaken by Prof. Chester C.T. Shu of the Department of Electronic Engineering;
 - b. HK\$237,000 to support a research project on the role of retinoic acid on limb development in transgenic mouse embryos undertaken by Prof. Kenneth K.H. Lee of the Department of Anatomy; and
 - c. HK\$300,000 as the first instalment of a donation to support a research project on the interplay of magnetic and superconducting properties of oxide multilayers undertaken by Dr. H.K. Wong of the Department of Physics.
 138. From Eisai (HK) Co. Ltd. HK\$30,000 to support a methycobal trial undertaken by the Department of Medicine.
 139. From Ferring Pharmaceuticals Limited HK\$30,000 to support a research project on precocious puberty in Chinese children undertaken by the Department of Paediatrics.
 140. From Friends of the Art Museum HK\$20,000 to provide a number of grants for postgraduate students of fine arts.
 141. From Glaxo Wellcome Hong Kong Limited:
 - a. to the Department of Surgery HK\$30,000 to support the research in neuro-otological surgery;
 - b. to the Department of Medicine
 - i. HK\$297,500 to support a clinical trial;
 - ii. HK\$160,000 to support a clinical trial on therapy for elderly hypertension;
 - iii. HK\$20,000 to sponsor a staff member to attend a meeting of neurosonology research in Salzburg, Austria, in September 1995; and
 - c. to the Department of Clinical Oncology HK\$30,000 to sponsor a staff member to attend the annual meeting of the American Society for Therapeutic Radiology and Oncology in Miami Beach, USA, in October 1995.
 142. From Mrs. Kwong Chan Choi-ping HK\$20,000 to support a research project conducted by Prof. C.S. Cockram of the Department of Medicine.
 143. From Mrs. Nancy Lee HK\$800 to support the project on research utilization in education and social sciences undertaken by Prof. C.Y. To.
 144. From Mr. Lo Chi-sang HK\$1,000 to the Department of Clinical Oncology for research purposes.

145. From Merck Sharp & Dohme (Asia) Limited:
 - a. to the Department of Surgery US\$5,000 to support a research project on long term effect of proscar on benign prostatic hypertrophy;
 - b. to the Department of Medicine
 - i. US\$40,000 to support a research study;
 - ii. HK\$24,000 to sponsor a staff member to attend an international symposium on drugs affecting lipid metabolism in Houston, USA, in November 1995; and
 - c. to the Department of Ophthalmology and Visual Sciences HK\$50,000 to support a clinical study.
146. From Pfizer Corporation:
 - a. HK\$10,000 to support a research project on head and neck prophylaxis with unasin undertaken by the Department of Surgery; and
 - b. HK\$50,000 to support a research project on prevalence of fungal infection at the Prince of Wales Hospital undertaken by the Department of Microbiology.
147. From Project Concern Hong Kong to the Department of Ophthalmology and Visual Sciences:
 - a. HK\$7,500 to support the research work on mobile eye service;
 - b. HK\$25,060 to support the clinical service at the mobile eye station;
 - c. HK\$7,500 to support the clinical service; and
 - d. HK\$85,500 to sponsor the appointment of a clinical tutor in July 1995 for one year.
148. From Rotary Club of Shatin HK\$30,000 to the Cardiothoracic Unit of the Department of Surgery for research and educational purposes.
149. From Sandoz Pharmaceuticals Limited:
 - a. HK\$70,000 towards the Diabetes and Endocrine Research Fund of the Department of Medicine; and
 - b. HK\$26,745 to support a staff member of the Department of Paediatrics to attend a meeting of the International Society of Paediatric Oncology in Montevideo, Uruguay, in October 1995.
150. From Sanofi Winthrop H.K. Ltd. to the Department of Medicine:
 - a. HK\$78,000 to support a neurological research project;
 - b. HK\$50,000 to support clinical research on haemodialysis; and
 - c. HK\$11,000 to support an international symposium on myocardial infarction held in March 1995.
151. From Serono Singapore Pte. Ltd. HK\$50,000 to support a clinical trial on portal hypertensive gastropathy undertaken by the Department of Medicine.
152. From Tronda Electronics Limited HK\$20,000 to support research and education of transcranial doppler sonography undertaken by the Department of Medicine.
153. From 3M Hong Kong Ltd. HK\$2,100 to support the academic meetings of the Intensive Care Unit of the Department of Anaesthesia and Intensive Care held during August–December 1995.
154. From the following donors to support the certificate course on ENT diseases for nurses organized by the Department of Surgery from September to December 1995:
 - a. Advance Electronic & Medical Industries Co. Ltd. HK\$2,000;
 - b. Johnson & Johnson Medical Hong Kong HK\$500;
 - c. Schering-Plough HK\$4,500;
 - d. Scienmed Laboratory & Medical Supplies Limited HK\$3,000; and
 - e. Swire Loxley Ltd. HK\$500.
155. From Advanced Chemicals Ltd. HK\$90,000 to support a lecture series organized by the Department of Chemistry.
156. From the following donors to support The Chinese University of Hong Kong Alumni Trail:
 - a. Alumni Association of The CUHK (Texas Chapter) US\$100;
 - b. CUHK New Asia College Alumni Association in Toronto CAD200;
 - c. Arden S. Law US\$108; and
 - d. Ontario Chung Chi Alumni Association CAD200.
157. From Alumni Association of National University of Amoy HK\$180,000 to sponsor the appointment of Prof. Cheng Tsu-yu as visiting senior research fellow in the Institute of Chinese Studies in 1996.
158. From an anonymous donor HK\$300,000 for the improvement of the campus of United College.
159. From Astra Pharmaceuticals (HK) Limited:
 - a. HK\$30,000 to sponsor two staff members of the Department of Medicine to attend a workshop in Scotland, UK, in July 1995;
 - b. HK\$1,390.35 to sponsor a staff member of the Department of Surgery to attend a meeting in Lisbon, Portugal, in March 1995; and
 - c. HK\$28,000 to sponsor a staff member of the Department of Paediatrics to attend the annual congress of the European Respiratory Society in Barcelona, Spain, in September 1995.
160. From Bei Shan Tang Foundation Limited HK\$8,170 to sponsor two staff members of the Art Museum to attend the commemorative ceremony of the 70th anniversary of the Palace Museum in Beijing in November 1995.

161. From Boehringer Ingelheim (HK) Limited HK\$6,000 to sponsor a staff member of the Department of Medicine to attend an annual meeting of the Australasian Society of Clinical Immunology & Allergy and a biennial meeting of the Transpacific Allergy & Immunology Society in Sydney, Australia, in October–November 1995.
162. From Bristol-Myers Squibb (HK) Limited HK\$8,000 to support the visit of a guest from the University of Chicago to the Department of Clinical Oncology in October 1995.
163. From Chou's Foundation HK\$50,000 to sponsor a student campus work scheme for 1995–96.
164. From Messrs. K.L. Chuang, S.Y. Kwan, S.K. Wei, Y.Y. Chuang and W.P. Chung HK\$12,000 to support the visit of Mr. You Rende of Tianjin Museum of Art to the University Art Museum in October 1995.
165. From Cochlear Pty. Limited AUD1,800 to sponsor two staff members of the Department of Surgery to attend a workshop in Melbourne, Australia, in July and in October–November 1995.
166. From Fandasy Co. Ltd. HK\$12,000 to sponsor a staff member of the Department of Surgery to attend the Asian-Australian Congress of Neurological Surgery in Taipei, in November 1995.
167. From Goldlion (Far East) Ltd. a further donation of HK\$85,000 for setting up a student campus work scheme from 1994 to 2003.
168. From Hang Seng Bank Limited HK\$1,273,619 to the University under the Affinity Card Programme.
169. From the following donors to sponsor a staff member of the Department of Ophthalmology and Visual Sciences to attend the annual meeting of the American Academy of Ophthalmology in Atlanta, USA, in October–November 1995:
 - a. Health Care Products Limited HK\$30,000; and
 - b. Pharmacia Asia Ltd. HK\$20,000.
170. From Hoechst China Ltd. HK\$25,000 to sponsor a staff member of the Department of Obstetrics and Gynaecology to attend an annual postgraduate programme of the American Society for Reproductive Medicine in Seattle, USA, in October 1995.
171. From The Hongkong Bank Foundation HK\$21,000 to sponsor student activities of the University in 1995–96.
172. From Hong Kong College of Cardiology HK\$56,154 to sponsor the appointment of a research nurse in the Department of Medicine from March to August 1995.
173. From The Hong Kong Mathematical Society HK\$20,000 to support an international symposium on functional analysis and related topics organized by the Department of Mathematics in December 1995.
174. From Hong Kong Ophthalmological Society HK\$15,000 to the Department of Ophthalmology and Visual Sciences for general purposes.
175. From Mr. Lo Siu-tong HK\$50,000 towards the discretionary fund of the Faculty of Arts.
176. From Olympus Optical Co. Ltd. HK\$21,000 to support the endoscopy training of the Department of Surgery.
177. From Oriental Press Charitable Fund Association to the Department of Surgery:
 - a. HK\$10,550 to support the Burns Foundation; and
 - b. HK\$1,100 to support the Skin Bank.
178. From Philips Hong Kong Ltd. HK\$44,000 to support a symposium on endovascular treatment of intracranial aneurysm organized by the Department of Surgery in November 1995.
179. From Polaroid Far East Ltd. US\$5,000 to support a doctor from PLA 301 Hospital in Beijing to participate in an academic exchange function organized by the Department of Diagnostic Radiology and Organ Imaging.
180. From Providence Foundation Limited:
 - a. HK\$1,019,990 to support the Paediatric Liver Transplantation Unit and the Childhood Incontinence Care Programme of the Department of Surgery; and
 - b. HK\$50,000 to support a visiting professorship scheme of the Department of Medicine.
181. From The Shaw Foundation Hong Kong Ltd. HK\$50,000 to the Department of Diagnostic Radiology and Organ Imaging for refurbishing and redecorating the room for the new ultrasound unit.
182. From Somjit Fusakun HK\$1,000 towards the Dr. Law Yu-fai Memorial Fund.
183. From Mr. Tse Ka-cheung HK\$500 to the Department of Social Work for purchasing reference books.
184. From Universal (Hong Kong) Co. HK\$24,000 as the first instalment of a donation to sponsor a scholar from Beijing to visit the University and to establish a collaborative project with Prof. Dominic T.W. Chan of the Department of Chemistry.
185. From Varian Pacific Incorporation HK\$11,595 to sponsor a physicist of the Department of Clinical Oncology to attend a meeting in Paris, France, in October–November 1995.
186. From various donors HK\$11,900 towards The

- Chinese University of Hong Kong Alumni Fund.
187. From various donors HK\$148,410 to support the Burns Charity Event undertaken by the Department of Surgery.
 188. From various donors gifts and donations totalling HK\$804,500 to the United College from July 1994 to June 1995.
 189. From Wellink Ltd. to the Department of Surgery:
 - a. HK\$16,500 to sponsor a staff member to attend a diagnostic and interventional radiology workshop in Singapore in October 1995; and
 - b. HK\$850 to support the certificate course on ENT diseases for nurses held from September to December 1995.
 190. From K.C. Wong Education Foundation:
 - a. HK\$35,000 to support scholars from China to participate in an international symposium on functional analysis and related topics organized by the Department of Mathematics in December 1995;
 - b. HK\$15,000 to sponsor Prof. Zhang Zhi-fen of Peking University to visit the Department of Mathematics in October–November 1995; and
 - c. HK\$15,000 to sponsor Prof. Hua Min of Fudan University to visit the Department of Economics in October 1995.
 191. From Armedic Far East Limited a donation covering air-ticket, registration fees and accommodation of a staff member of the Department of Medicine attending the Asian-Pacific Congress of Cardiology in Bali, Indonesia, in September 1995.
 192. From Novo Nordisk A/S a donation covering air-ticket and accommodation of a staff member of the Department of Obstetrics and Gynaecology attending the Asian and Oceanic Congress of Obstetrics and Gynaecology in Bali, Indonesia, in October 1995.
 193. From Sun Microsystems of California Ltd. a donation of three SPARC-station 5 to the Department of Computer Science and Engineering.
 194. From Providence Foundation Limited:
 - a. for postgraduate students of clinical psychology
 - i. HK\$260,000 to provide four scholarships of \$30,000 each in 1995–96 and four of \$35,000 each in 1996–97;
 - ii. HK\$40,000 to provide four research grants of \$5,000 each for 1995–96 and 1996–97;
 - b. for full-time undergraduate students in 1995–96
 - i. HK\$70,000 to provide a number of bursaries; and
 - ii. HK\$80,000 to provide 10 scholarships of \$8,000 each.
 195. From Sik Sik Yuen HK\$75,000 annually to provide three scholarships of \$25,000 each for outstanding students of the Faculty of Education.
 196. From Universita Cattolica del Sacro Cuore ITL 16,800,000 to provide 12 awards of ITL 1,400,000 each for students who are studying Italian to attend an international workshop at the Universita in the summer of 1996.
 197. From University Lodge of Hong Kong No.3666, E.C., HK\$7,000 to provide a golden jubilee bursary for a needy student in 1995–96.
 198. From Chiang Ching Kuo Foundation for International Scholarly Exchange:
 - a. a further donation of US\$5,545.61 to support the publication of *Modern Times* of the Research Centre for Translation;
 - b. a further donation of US\$10,439.34 to support a research project on food culture in Taiwan undertaken by Prof. David Wu of the Department of Anthropology;
 - c. a further donation of US\$7,631.15 to support a research project on the oral architectural history of China undertaken by Prof. Tunney Lee of the Department of Architecture; and
 - d. a further donation of US\$8,243.57 to support a comparative study of Chinese and world history undertaken by Prof. Leung Yuen-sang of the Department of History.
 199. From Janssen Pharmaceutica:
 - a. HK\$50,000 to sponsor the editorial expenses of the *Textbook of Clinical Medicine for South East Asia* published by the Department of Medicine; and
 - b. HK\$30,000 to sponsor a visiting professor to attend the clinical pharmacy programme undertaken by the Department of Pharmacy in December 1995–January 1996.
 200. From Mr. Preston Lai and Miss Chan Ngar-ping, Amy HK\$35,000 to support the publication of the Cantonese Opera Research Programme undertaken by Prof. Chan Sau-yan of the Department of Music.
 201. From Armedic Far East Limited:
 - a. HK\$100,000 to support a clinical study on the impact of anti-hypertensive therapy undertaken by the Department of Medicine; and
 - b. a donation (covering the air-ticket, registration fee and accommodation) for a staff member of the Department of Psychiatry to attend the European College of Neuropsychopharmacology Congress in Venice, Italy, in September–October 1995.
 202. From Bei Shan Tang Foundation Limited HK\$443,200 to support the archaeological

- excavation project on Lamma Island undertaken by the Centre for Chinese Archaeology and Art.
203. From Bristol-Myers Squibb (HK) Limited HK\$140,000 to support the *in vitro* studies of cefepime and cefprozil undertaken by the Department of Microbiology.
 204. From Father Barrett Charitable Foundation HK\$135,000 to support the eye care project undertaken by the Department of Ophthalmology and Visual Sciences.
 205. From Ferring Pharmaceuticals Limited to the Department of Surgery:
 - a. HK\$80,000 to support a research project on primary nocturnal enuresis in relation to desmopressin therapy in Hong Kong children; and
 - b. a donation (covering the air ticket, registration fee and accommodation) for a staff member to attend an international symposium on children's continence in Sydney, Australia, in October 1995.
 206. From Friends of the Art Museum:
 - a. to the Department of Fine Arts HK\$20,000 to provide a number of research grants for postgraduate students;
 - b. to the Art Museum
 - i. HK\$250,000 towards the acquisition fund; and
 - ii. HK\$30,000 to support a summer work-study programme.
 207. From Ginseng Board of Wisconsin Inc. US\$5,000 to support a research project on chemical differentiation of American and oriental ginsengs undertaken by the Chinese Medicinal Material Research Centre.
 208. From Glaxo Wellcome Hong Kong Limited to the Department of Surgery:
 - a. HK\$65,000 to support a clinical trial on the prevention of nausea and vomiting after ear surgery;
 - b. HK\$4,500 to support the certificate course on ENT diseases for nurses conducted from September to December 1995; and
 - c. HK\$8,000 to sponsor a staff member to attend the Annual Meeting of the American Academy of Otolaryngology — Head and Neck Surgery, in New Orleans, USA, in September 1995.
 209. From Lee Foundation, Singapore, a further donation of MYR50,000 to support a research project on Chinese political parties in Malaysia undertaken by Dr. Chang Chak-yan under the auspices of the Hong Kong Institute of Asia-Pacific Studies.
 210. From Mrs. Nancy Lee HK\$200 to support the project on research utilization in education and social sciences undertaken by Prof. C.Y. To.
 211. From Oriental Press Charitable Fund Association:
 - a. to the Department of Medicine HK\$100,100 to support the Hong Kong Lupus Nephritis Study;
 - b. to the Department of Surgery
 - i. HK\$13,530 towards the Burns Foundation; and
 - ii. HK\$2,950 to support the Skin Bank.
 212. From Pfizer Corporation HK\$38,000 to support a clinical study on renal function and blood pressure control in renal transplant patients undertaken by the Department of Medicine.
 213. From Rhone-Poulenc Rorer Limited US\$4,000 to support a clinical trial on breast cancer undertaken by the Department of Clinical Oncology.
 214. From Takeda IMC Chemical Ltd. HK\$100,000 to support the research project on helicobacter pylori infection undertaken by the Department of Medicine.
 215. From The Hong Kong College of General Practitioners HK\$18,000 to the Department of Surgery for research purposes.
 216. From The Yuen Yuen Institute HK\$2,500,000 to support a research on Chinese classics of educational significance at the University undertaken by Prof. C.Y. To of the Research Institute for the Humanities jointly with the Institute of Chinese Studies.
 217. From Tung Wah Group of Hospitals HK\$3,500 to support the children's eyes screening project undertaken by the Department of Ophthalmology and Visual Sciences.
 218. From Wei Lun Foundation Limited HK\$500,000 to support the research project on atherosclerosis in the Chinese undertaken by the Department of Medicine.
 219. From Mrs. Helena Wong HK\$10,000 to the Hong Kong Cancer Institute for research purposes.
 220. From Yat Chau Company Limited HK\$2,000 to support a research project on quality control on Chinese medicines undertaken by the Chinese Medicinal Material Research Centre.
 221. From the following donors to support the certificate course on ENT diseases for nurses organized by the Department of Surgery from September to December 1995:
 - a. Abbott Laboratories Limited HK\$4,500; and
 - b. Celki Medical Co. HK\$5,000.
 222. From Albert Kunstadter Family Foundation US\$3,000 to support the Centre for Planning, Architecture and Development of the Department of Architecture.
 223. From Allergan Asia Limited US\$4,000 to sponsor a staff member of the Department of Ophthalmology and Visual Sciences to attend an annual meeting of the American Academy of

- Ophthalmology held in Atlanta, USA, in October–November 1995.
224. From Astra Pharmaceuticals (HK) Limited:
 - a. to the Department of Surgery HK\$25,000 for educational purposes;
 - b. to the Department of Medicine a donation (covering air-tickets and accommodation) for four staff members to respectively attend the following:
 - i. United European Gastroenterology Week in Berlin, Germany, in September 1995;
 - ii. the European Society of Cardiology Congress in Amsterdam, the Netherlands, in August 1995;
 - iii. a meeting on asthma in Vienna, Austria, in October 1995; and
 - iv. scientific sessions of the American Heart Association in California, USA, in November 1995.
 225. From Bayer Diagnostics HK\$3,000 to support the opening ceremony of the diabetes education and management course organized by the Department of Medicine in September 1995.
 226. From Mr. Robert B. Boardman US\$100 towards the Dr. Law Yu-fai Memorial Fund.
 227. From Boehringer Ingelheim (HK) Limited HK\$5,000 to support the honorary clinical tutors' meeting organized by the Department of Community and Family Medicine in December 1995.
 228. From Mr. Louis Cha HK\$42,000 to support the Chinese pathologist fellowship programme undertaken by the Department of Anatomical and Cellular Pathology.
 229. From the following donors towards The Hong Kong Paediatric Bone Marrow Transplant Fund of the Department of Paediatrics:
 - a. Ms. Doris Chan HK\$500;
 - b. Miss Hung Lai-lai HK\$1,000; and
 - c. Mr. Hung Tuen-yuen HK\$5,000.
 230. From the following donors to support The Chinese University of Hong Kong Alumni Trail:
 - a. Mr. Daniel Cheng HK\$500; and
 - b. Ms. Hong Man-wah, Ranee HK\$500.
 231. From Coherent Pacific HK\$50,000 to support a workshop on transurethral holmium laser prostatectomy organized by the Department of Surgery in October 1995.
 232. From Elekta Instruments Asia Limited HK\$4,000 to sponsor a visitor to give a lecture at the Department of Surgery in November 1995.
 233. From Eli Lilly Asia Inc. HK\$9,000 to sponsor a staff member of the Department of Paediatrics to attend a conference on the status of Turkish and world children in Istanbul, Turkey, in October 1995.
 234. From the following donors to support a conference on translation into Chinese organized by the Department of Translation in April 1996:
 - a. Longman Asia Limited HK\$10,000;
 - b. Oxford University Press HK\$10,000; and
 - c. Reader's Digest Association Far East Limited HK\$10,000.
 235. From the following donors to support a workshop on rehabilitation technology organized by the Department of Orthopaedics and Traumatology at Hua Shan Hospital, Shanghai Medical University, in November 1995:
 - a. Medical Technologies Ltd. HK\$10,000; and
 - b. Medisport Limited HK\$10,000.
 236. From Novo Nordisk A/S HK\$10,451 to sponsor a staff member of the Department of Obstetrics and Gynaecology to attend the Asian and Oceanic Congress of Obstetrics and Gynaecology in Bali, Indonesia, in October 1995.
 237. From Pharmacia Asia Ltd.:
 - a. HK\$5,000 to sponsor a staff member of the Department of Clinical Oncology to attend the Asia Pacific Cancer Congress in Singapore in October 1995; and
 - b. HK\$10,000 to sponsor a staff member of the Department of Medicine to attend the Asian Pacific Congress of Allergology and Clinical Immunology in Taiwan in November 1995.
 238. From Project Concern Hong Kong HK\$85,800 to sponsor the appointment of a clinical tutor in the Department of Ophthalmology and Visual Sciences for one year from July 1995.
 239. From Schering-Plough HK\$5,000 to sponsor a staff member of the Department of Paediatrics to attend the Asian Pacific Congress of Allergology and Clinical Immunology in Taiwan in November 1995.
 240. From Varian Pacific Incorporation HK\$9,097 to sponsor an honorary lecturer of the Department of Clinical Oncology to attend an international conference on brachytherapy in Nice, France, in November 1995.
 241. From various donors HK\$17,770 to support the Burns Charity Event organized by the Department of Surgery.
 242. From various donors HK\$3,500 towards The Chinese University of Hong Kong Alumni Fund.
 243. From various donors gifts and donations totalling HK\$2,447,483.12 to Chung Chi College between May and October 1995.
 244. From various donors to support the Information Technology Fair '95 organized by the Computer Services Centre and the Information Technology Service Unit in September 1995:
 - a. cash donations totalling HK\$28,000; and
 - b. donations of souvenirs for visitors to the Fair.



香港中文大學

The Chinese University of Hong Kong