

Ka-Band Dual-Mode Super Q Filters and Multiplexers

Bahram Yassini, *Member, IEEE*, and Ming Yu, *Fellow, IEEE*

Abstract—A new class of Ka-band filters and multiplexers with extremely low center frequency insertion loss and excellent out-of-band performance are introduced using dual-mode super Q resonators. New coupling configurations and filter layouts are presented. A cross-coupled dual-mode super Q filter with end-launch is introduced in this work. Two high-power multiplexer designs using super Q filters are demonstrated. The results are supported by measured performance at ambient and over temperature.

Index Terms—Coupling, dual mode, filter, filter design, high power, multiplexer, quality (Q) factor, resonator.

I. INTRODUCTION

THE HISTORY of passive components for satellite payloads extends back many years with the invention of dual-mode filters, switches, dielectric resonator filters, and temperature compensated multiplexers [1]. As a result, payload architectures have evolved to the characteristics specific to these advances with ever increasing power level and frequency ranges. Ka-band satellite payloads (17–33 GHz typical) often require narrowband and/or high-power (125–450 W) channelization to meet the growing demands. A high-quality (Q) factor filter is the key component to realize this functionality, as filters often have smaller size, higher insertion loss, and thermal dissipation.

The typical Ka-band output multiplexer technology is based on TE_{11N} dual-mode filters ($N = 1–5$) [1]–[4] or single-mode TE₀₁₁ [5], [6] technology. Although they offer reasonable Q from 12 000 to about 16 000 (loaded), they will still be struggling to meet the new market demand.

A new class of filters and multiplexers presented in this paper incorporates dual-mode super Q cavity resonators to address very high Q and high-power applications. The super Q filter structure first introduced in [7] by the authors has a layout that is disadvantageous to many high-power multiplexer applications, where an inline configuration may be desired. It also limits the number of channels and degrades performance stability of a multiplexer. The design in [7] suffers from poor out-of-band performance due to the spurious loading that consequently limits the multiplexer bandwidth. A new coupling iris set is introduced in this paper to address those issues. Two

new filter layouts to improve power handling, channel density, and compactness of high-power multiplexers are also presented here together with measured filter and multiplexer responses. Reduced filter insertion loss brings with it a key benefit for both the input (low power) and output (high power) portion of a satellite payload, resulting in significant improvements in enabling an increase in output power [and consequently, effective isotropic radiated power (EIRP)], narrower channelization capability (better shape factor), and/or decreasing dc power consumption.

II. SUPER Q RESONATOR [7]

Fig. 1 shows transverse modal field distributions for a circular waveguide. TE₂₂ mode (13th) is marked by its characterization vector among these modes. A super Q resonator is a cylindrical waveguide cavity operating in a dual-mode TE₂₂₁ with a specific dimension that provides an extremely high quality factor together with the widest spurious free window. Modal fields of each TE₂₂₁ mode of the resonator are orthogonal and their characterization vectors are spaced by 45° in respect to each other. These two modes are coupled to each other by placing any kind of discontinuity between their characterization vectors [7]. Typically a super Q resonator provides 55% higher quality factor than a TE₀₁₁ resonator, which is known to have higher Q than TE_{11N} mode. Typical dimensions and quality factors of TE₀₁₁ and TE₂₂₁ cavity resonators with silver-plated walls are shown in Table I.

In theory, the super Q silver-plated resonator provides more than 31 000 unloaded Q and a 1500-MHz spurious-free window at 20 GHz (Fig. 2). This window is adequate to design a 600-MHz-wide multiplexer with about 150-MHz frequency margin. The spurious-free window can be easily degraded by the loading effect caused by coupling irises and other discontinuities in a filter realization. It is evident in [7] that out-of-band rejection at the high side of the frequency band is poor. It is found that this prevents users from building wider band multiplexers. Therefore mode charts and modal field distributions should be carefully re-examined in the course of designing a new filter.

III. NEW SUPER Q FILTERS

The filter presented in [7] is an end-wall coupled with side-launch waveguide ports facing the opposite direction. It uses three radial coupling irises (3R iris set, Fig. 3 and Table II) to realize direct and cross coupling. In order to address the issues mentioned in Section I, new filter layouts and new iris sets will be investigated.

Manuscript received March 02, 2015; revised June 14, 2015 and July 22, 2015; accepted July 23, 2015. Date of publication August 13, 2015; date of current version October 02, 2015.

The authors are with COM DEV Ltd., Cambridge, ON, Canada N1R 7H6 (e-mail: ming.yu@ieee.org).

Color versions of one or more of the figures in this paper are available online at <http://ieeexplore.ieee.org>.

Digital Object Identifier 10.1109/TMTT.2015.2462822

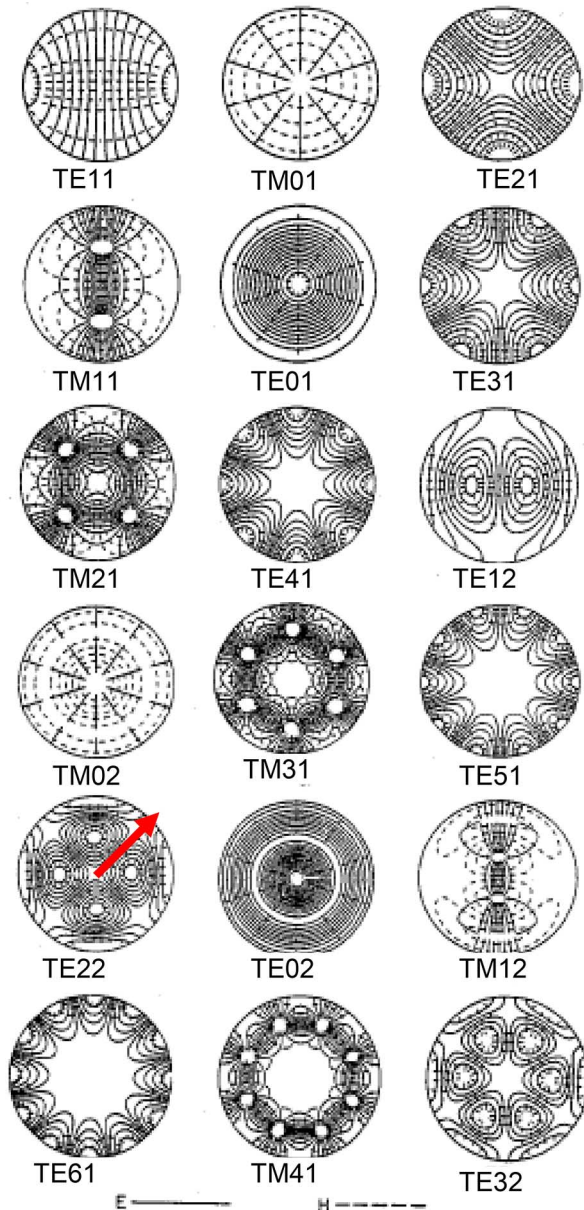

Fig. 1. Transverse modal field distributions of TE221 super Q and the crowded spurious resonances at its vicinity [8].

TABLE I
SUPER Q CAVITY PARAMETERS AT 20 GHz

| Parameter/Mode | TE011 | TE221 |
|--------------------------------------|-------|-------|
| Diameter (inch) | 0.85 | 1.365 |
| Length (inch) | 0.6 | 0.765 |
| Q (Silver plated wall) | 20000 | 31000 |
| Q improvement comparing to TE011 (%) | N/A | 55 |

The end-cap current distribution of a TE221 resonator follows the TE22 electric field pattern and distribution. The magnetic field follows the same distribution, but is perpendicular to it. Therefore, an ideal coupling iris is perpendicular to the electric field pattern (or current distribution on the end cap) and located at its maxima. Radial and angular irises are two possible choices, as shown in Fig. 3 and Table II.

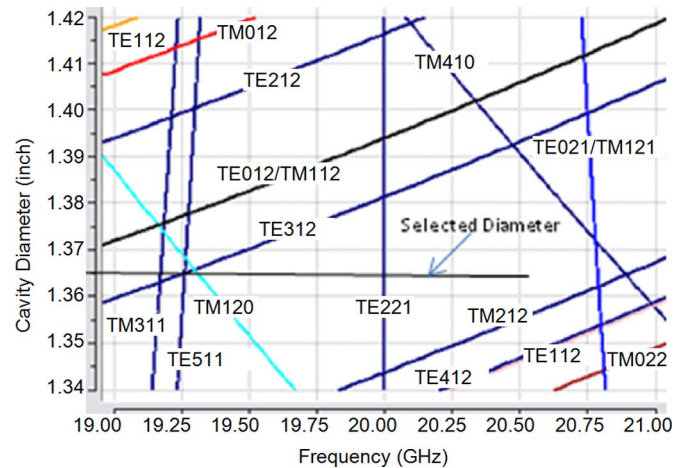

Fig. 2. Super Q TE221 resonator mode chart.

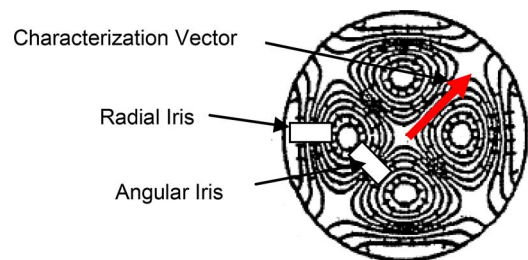

Fig. 3. Angular and radial irises at the end wall of two coupled super Q cavities. Coupling irises can be populated at 90° interval.

TABLE II
IRIS POSITION IN RELATIVE TO CAVITY RADIUS R

| Iris type | Radial | Angular |
|-----------|--------|---------|
| position | 0.73R | 0.32R |

A. Inline Layout

An inline end-launch super Q filter layout is shown in Fig. 4(a). The filter function is the same as the one presented in [7] with four poles and two transmission zeros. Tuning screws as in [7] and new flat surfaces (sections of cavity wall with no curvature) are employed to realize coupling between two modes in each cavity. This newly proposed flat surface serves as a fixed discontinuity realizing the same coupling value as a tuning screw, but with very small and smooth penetration into the cavity. It improves the tuning range and reduces the risk of excess tuning screw penetration, which causes performance degradation.

Designing iris sets for coupling between cavities and also input/output coupling is very challenging since it can significantly affect out-of-band performance by loading the crowded spurious resonances. This issue will be further discussed in Section III-B where we compare different iris sets.

Fig. 4(a) shows the filter structure and iris arrangement of the inline filter. Coupling between cavities are realized by one angular iris for m23 and one radial iris for m14. An angular iris is also selected for input/output couplings. Input and output ports and their corresponding coupling irises are spaced at 90° with respect to each other to improve out-of-band performance, and

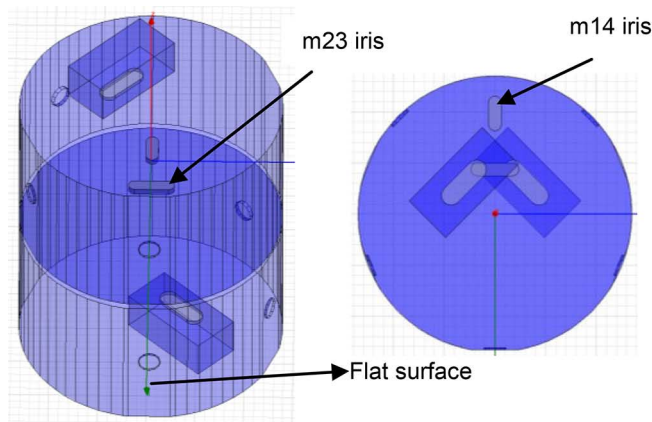

(a)

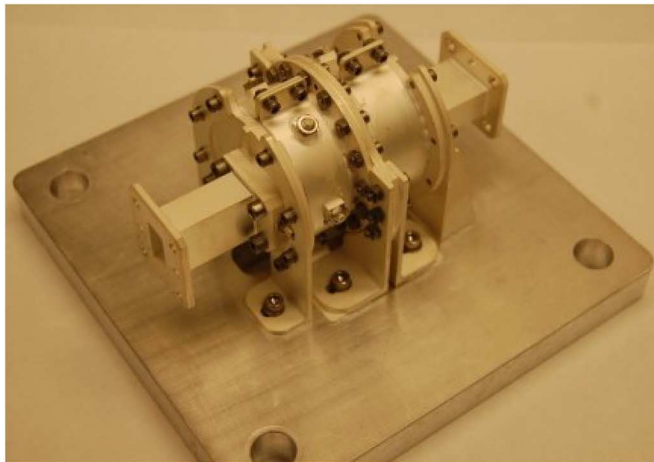

(b)

Fig. 4. Inline four-pole super Q filter: (a) layout and (b) photograph.

to reduce stray couplings. The 90° port rotation allows for manifold E -plane T-junction, while the channel input port is horizontal and offset from the cavity center (located very close to the base plate). This layout is very efficient for thermal performance and consequently power handling. Coupling irises are lined up at 45° with respect to the input/output coupling, as shown in Fig. 4(a).

A photograph of a fabricated inline super Q filter is shown in Fig. 4(b). Two filters are designed and fabricated. Center frequencies of these filters are set at 19.700 and 20.18 GHz. Each filter bandwidth is 32 MHz. Fabricated filters are tuned to the desired center frequencies and bandwidth using tuning screws and replaceable irises in the same way, as explained in [7].

Wideband simulated and measured performances of the fabricated filters are shown in Fig. 5 with good correlation. Wideband performance shows a very clean spurious performance with a free window of approximately 1350 MHz measured from spurious spikes. Filters are spaced at 480 MHz from each other and no spurious spike is closer than 100 MHz to their band edge. That will ensure adequate spurious spacing margin to realize a multiplexer with a bandwidth of more than 500 MHz. The in-band performances shown in Fig. 6 demonstrates very small CF insertion loss of less than 0.4 dB (corrected with 0.04 dB caused by adaptors) and more than 25 000 Q (as expected). Both

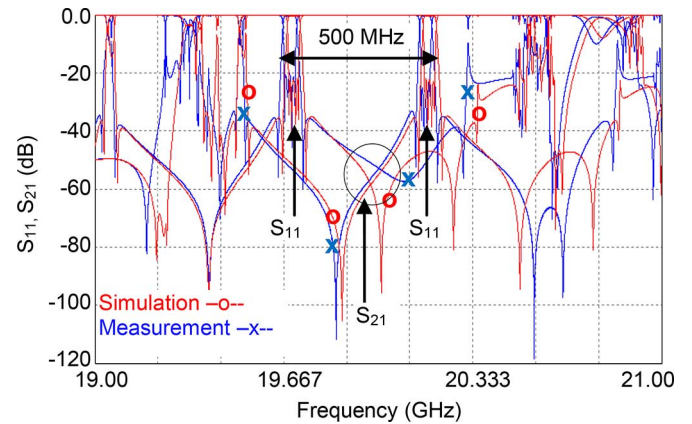

Fig. 5. Wideband (inline filter) RF performance.

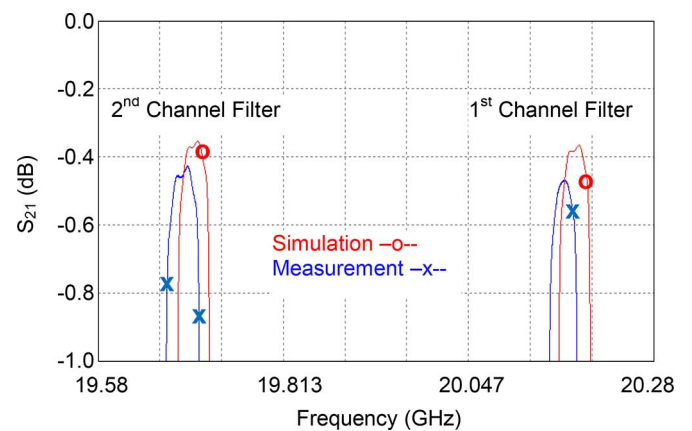
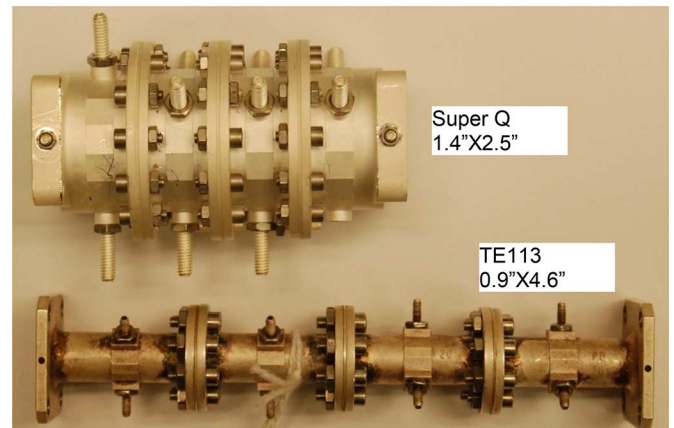

Fig. 6. In-band (inline filter) RF performance.

Fig. 7. 30-GHz eight-pole super Q filter and a TE113 version with the same filter function.

filters are tuned to almost 14 MHz lower frequencies to experiment tuning range. Super Q cavity filter has around 20 MHz total tuning range at 20 GHz.

The inline four-pole filter is also expandable to provide higher order functions for input multiplexer applications. Fig. 7 shows a photograph of an eight-pole super Q inline filter (center frequency: 30 GHz bandwidth: 40 MHz). A TE113 version is also shown on the side for size comparison. Electromagnetic (EM) simulation and measurement of this filter are shown in Fig. 8.

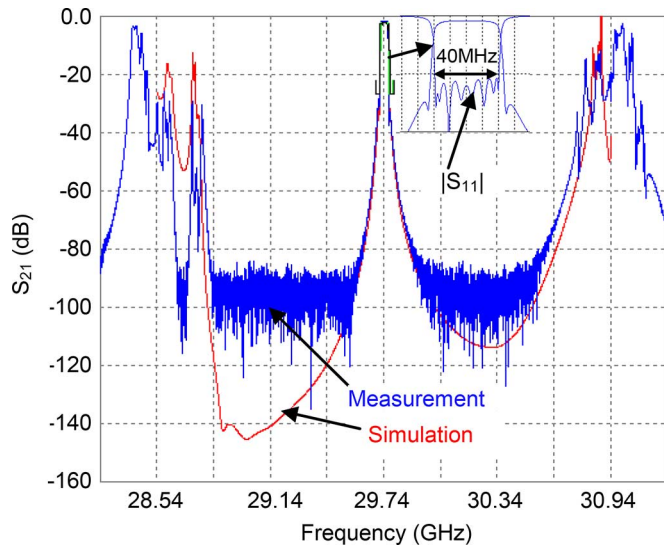

Fig. 8. Wideband RF performance of the fabricated eight-pole super Q filter operating at 30 GHz with 40-MHz bandwidth.

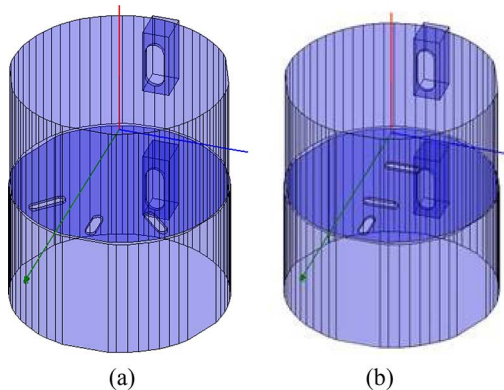

Fig. 9. Two vertical layouts. (a) 3R iris set. (b) 2A1R iris set.

Excellent RF performance with loaded Q of 20 000 at 30 GHz is demonstrated in a very attractive compact size. CF insertion loss is 2 dB versus 4 dB for the TE113 version.

B. Vertical Layout

A side launch layout with ports facing the same side is very attractive for its compact size, as will be explained later in the multiplexer design section. Fig. 9 shows two vertical filter layouts. The layout shown in Fig. 9(a) employs three radial irises (3R iris set) and has the same iris set as the filter reported in [7]. The layout presented in Fig. 9(b) has two angular irises to realize m23 and one radial iris for m14 (2A1R iris set).

Simulation shows that the 2A1R iris set provides a wider spurious-free window with better isolation, particularly for wideband applications. This design is derived after careful examination of field plots in Figs. 1 and 2. It is evident that radial irises can heavily load high-frequency spurious modes, particularly TM410, TM212, and TE021. Radial irises are perpendicular to the electric field, and consequently, also to the current direction of those modes. However, angular irises are parallel to those electric fields and also farther from their maximum. Therefore, an angular iris should have less loading effect on those modes

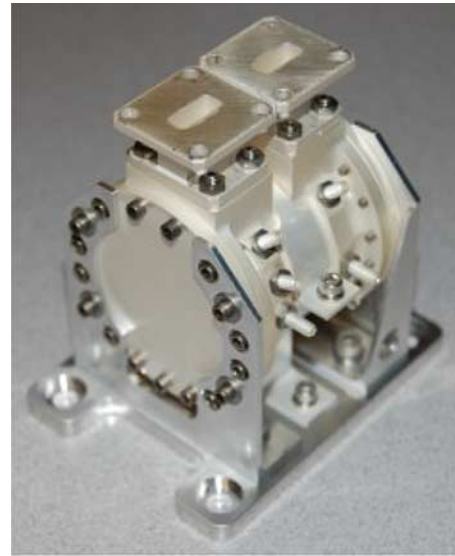

Fig. 10. Fabricated vertical super Q filter.

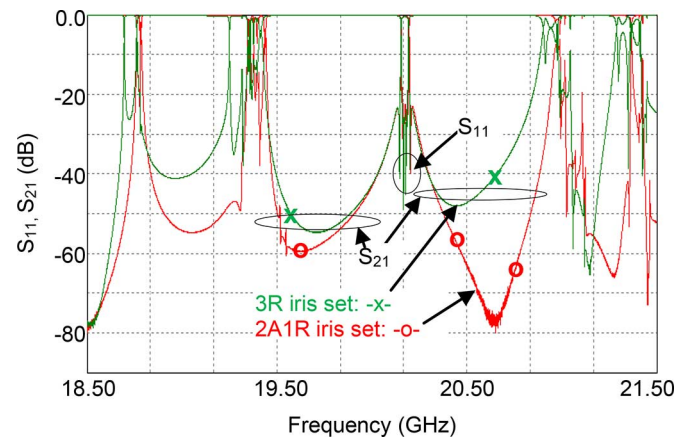

Fig. 11. Wideband measured RF performance for a vertical super Q layout. 2A1R iris set outperform 3R version.

than a radial iris. That also explains the choice of angular irises for the inline layout in Section III A. The radial iris is still used in cross coupling.

Fig. 10 shows a photograph of a fabricated vertical super Q filter using a 2A1R iris set. It is a four-pole filter with two transmission zeros operating at Ka-band. Input and output ports are WR42 waveguides.

Fig. 11 shows measured wideband performance of both 3R and 2A1R versions for a 32-MHz bandwidth filter centered at 20.175 GHz. Significant out-of-band improvement is achieved using the 2A1R iris set, as shown in that figure. Fig. 12 demonstrates a very good correlation between EM simulation and measurement. Measured in-band performance of this filter is shown in Fig. 13. The CF insertion loss is around 0.4 dB and extracted Q is better than 25 000.

IV. SUPER Q MULTIPLEXER LAYOUTS

A high-power two-channel multiplexer employing the introduced filter in [7] is shown in Fig. 14. Filters are laid out horizontally to maintain the shortest distance to the base-plate. An

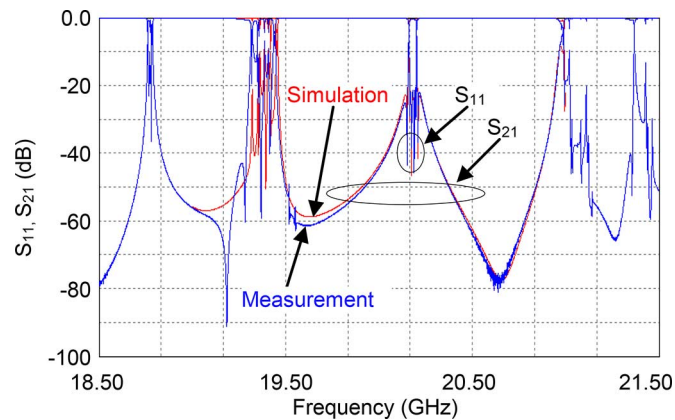

Fig. 12. Simulation versus measurement for a standalone vertical super Q filter with 2A1R iris set.

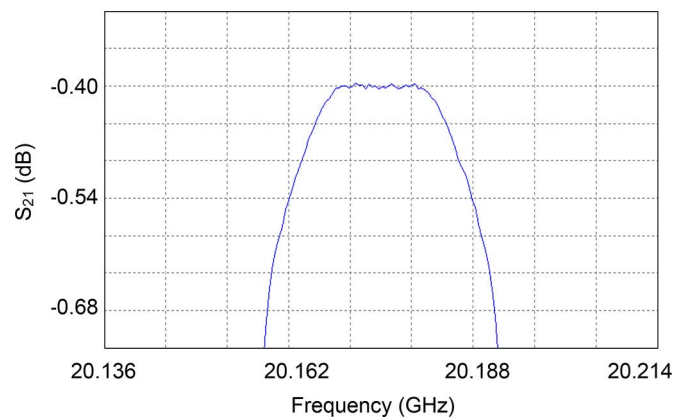

Fig. 13. In-band measured performance of the vertical super Q standalone filter with 2A1R iris set. Better than 0.4-dB CF insertion loss equivalent to more than 25 000 Q is demonstrated.

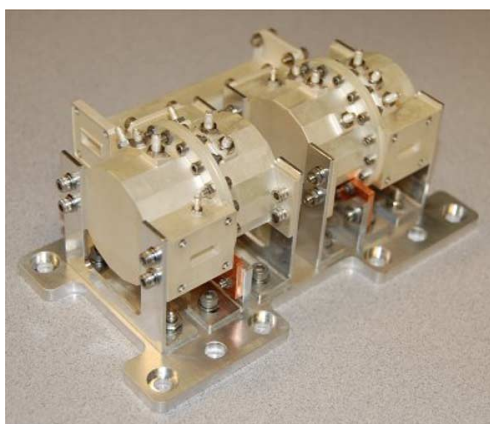

Fig. 14. Two-channel super Q multiplexer in a horizontal configuration using filter layout presented in [7].

H -plane T-junction is used to connect filters to the manifold. Brackets are used to conduct the heat from cavities to the base-plate.

This design has a size disadvantage, as the manifold length becomes very long for a large number of channels due to the

TABLE III
2CH SUPER Q FREQUENCY PLAN

| Channel no | Center Frequency (MHz) | Bandwidth (MHz) |
|------------|------------------------|-----------------|
| 1 | 20180 | 32 |
| 2 | 20060 | 32 |

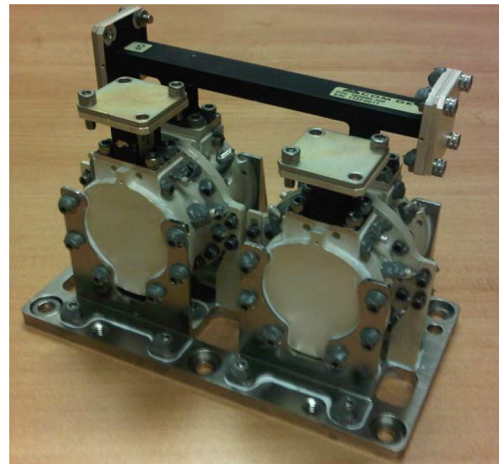

Fig. 15. Two-channel high-power multiplexer using vertical super Q filter layout.

large channel spacing. Therefore it is very challenging to maintain RF/thermal/mechanical performance for the high-density multiplexer using this layout.

A. Multiplexer Using Vertical Layout

A new compact two-channel Ka-band high-power multiplexer using a vertical super Q filter is designed based on the frequency plan shown in Table III. A photograph of this multiplexer is shown in Fig. 15. It is a multiplexer with 32-MHz channel bandwidth. The channel filter function is a four-pole with two transmission zeros. The manifold is silver-plated aluminum WR42 waveguide and channel filters are made of silver-plated Invar. It is a comb-line layout with a manifold E -plane T-junction. This layout provides shorter manifold and channel spacing, and consequently, better performance stability than the horizontal version.

Proper strapping and brackets are designed through a comprehensive thermal analysis based on computed dissipation distribution to conduct the heat from the multiplexer to the base plate. The designed multiplexer is tuned successfully to the desired frequency and bandwidth using tuning screws and coupling iris adjustment. This unit is tested successfully for 180-W power handling at an environmental temperature of 85 °C. Recorded RF performance is shown in Fig. 16. Wideband RF performance shows that this multiplexer is capable of providing up to 600-MHz bandwidth. Fig. 17 shows in-band channel performance over a temperature range of -7 °C to 112 °C. Table IV summarizes the thermal performance. Channel CF insertion loss is 0.51 dB at ambient, which represents a Q value of 25 500, as predicted. CF insertion loss increases to 0.57 dB at hot (112 °C) and extracted Q is 22 000 at that temperature. The multiplexer shows a thermal drift of less than 2 ppm, as shown

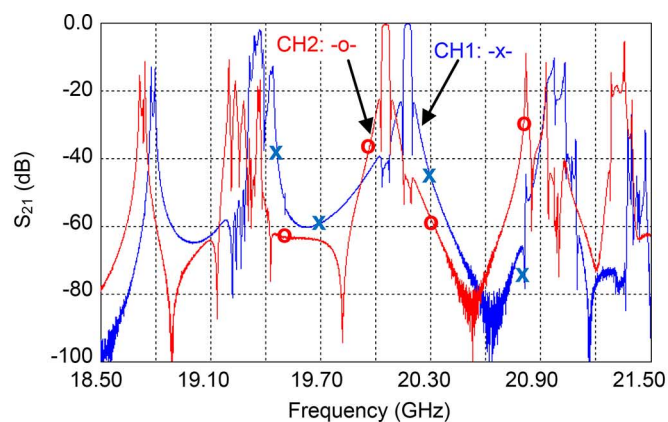

(a)

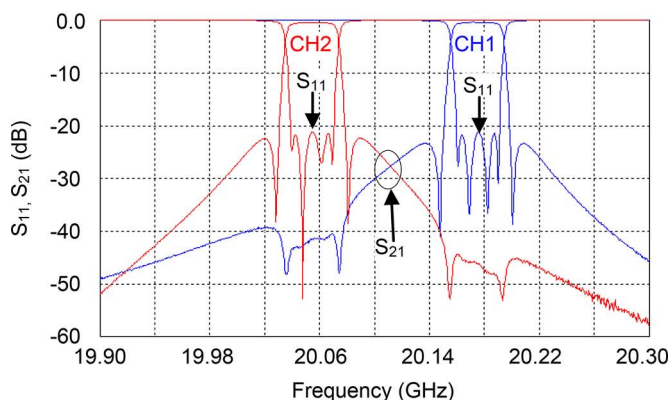

(b)

Fig. 16. Vertical super Q multiplexer measured RF performance (a) Wideband. (b) Narrowband.

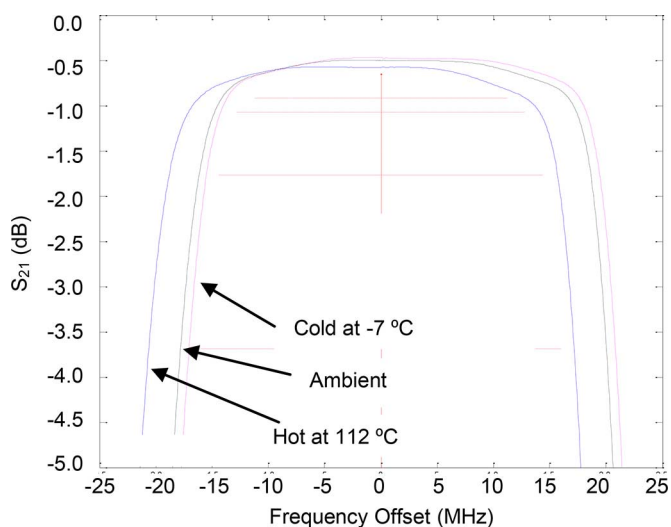

Fig. 17. Vertical super Q multiplexer. Thermal performance at cold ($-7\text{ }^{\circ}\text{C}$), ambient and hot ($112\text{ }^{\circ}\text{C}$).

in Fig. 17. Higher thermal drift in comparison to the reported standalone filter in [7] is due to the added mechanical features (straps and brackets) that are incorporated in the channel filters for performance stability over temperature, shock, and vibration.

TABLE IV
2CH SUPER Q THERMAL PERFORMANCE SUMMARY

| Temperature | Prediction | Measured | |
|---------------------------------------|------------------------|------------------------|-------------|
| | CF Insertion Loss (dB) | CF Insertion Loss (dB) | Extracted Q |
| Ambient | 0.51 | 0.5 | 25500 |
| Hot ($112\text{ }^{\circ}\text{C}$) | 0.58 | 0.57 | 22000 |

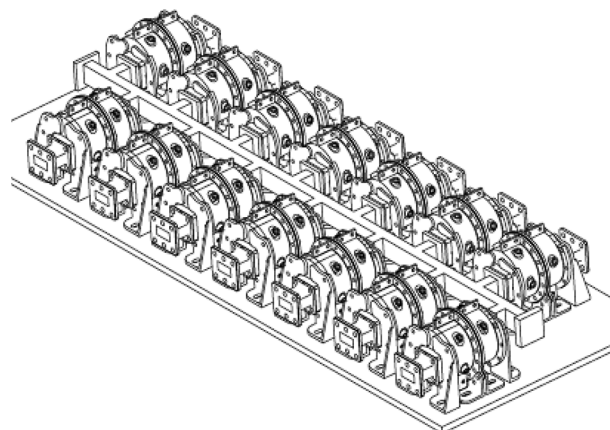

Fig. 18. 14-channel herringbone high-power output multiplexer using inline super Q channel filters.

B. Multiplexer Using Inline Layout

The vertical layout is very attractive for its compact size, but it has the disadvantage of having a long heat path at channel filter ports. Thermal analysis shows that a more efficient heat path from channel filter ports to the base plate will improve power handling significantly. The inline version with the end-launch is a very attractive layout for these kinds of configurations. It allows for designing clamps that cover the entire cavity sidewall and short brackets from waveguide ports to the base-plate. An inline design will also enable a herringbone layout that will help to further stabilize RF performance over a wide temperature range for the high-density multiplexer applications.

A 14-channel herringbone multiplexer concept design layout using an inline super Q channel filter is shown in Fig. 18. Manifold T-junctions are E -plane, while channel input ports are horizontal to the base-plate. Thermal analysis shows that more than 60% higher power handling is achievable in this configuration compared to the vertical version.

V. CONCLUSION

A new class of high-power filters and multiplexers using dual-mode super Q cavity resonators is presented with extensive simulation and measurement data. An end-launch inline layout suitable for at least 50% higher power handling and higher number of channels is presented in this paper. The inline version is also demonstrated in a higher order filter design at 30 GHz, which is very compact and suitable for input multiplexer applications. A 20-GHz two-channel ($Q > 25\,000$) vertical multiplexer with 32-MHz channel bandwidth is designed, fabricated, and tested. Power handling of 180 W for an Invar multiplexer at the environmental temperature of $85\text{ }^{\circ}\text{C}$

is reported. These results proved the feasibility of wideband (>500 MHz) multiplexer design using super Q cavity resonators.

REFERENCES

- [1] C. Kudsia, R. Cameron, and W. Tang, "Innovations in microwave filters and multiplexing networks for communication satellite systems," *IEEE Trans. Microw. Theory Techn.*, vol. 40, no. 6, pp. 1133–1149, Jun. 1992.
- [2] C. Arnold and D. Wolk, "Temperature compensated high power aluminium OMUX for communication satellites," in *Eur. Microw. Week, Manchester, U.K.*, Oct. 2011, Passive Hardware for Space Applications Workshop.
- [3] R. J. Cameron, C. M. Kudsia, and R. R. Mansour, *Microwave Filters for Communication Systems*. Hoboken, NJ, USA: Wiley, 2007.
- [4] A. E. Williams and A. E. Atia, "Dual-mode canonical waveguide filters," *IEEE Trans. Microw. Theory Techn.*, vol. MTT-25, no. 12, pp. 1021–1026, Dec. 1977.
- [5] A. E. Atia and A. E. Williams, "General TE₀₁₁-mode waveguide band-pass filters," *IEEE Trans. Microw. Theory Techn.*, vol. MTT-24, no. 10, p. 640, Oct. 1976.
- [6] B. Yassini, M. Yu, and B. Keats, "A Ka-band fully tunable cavity filter," *IEEE Trans. Microw. Theory Techn.*, vol. 60, no. 12, pp. 4002–4012, Dec. 2012.
- [7] B. Yassini and M. Yu, "A novel ka band dual mode super Q cavity filter," in *IEEE MTT-S Int. Microw. Symp. Dig.*, Jun. 2014, pp. 1–3.
- [8] C. S. Lee, S. W. Lee, and S. L. Chuang, "Plot of modal field distribution in rectangular and circular waveguides," *IEEE Trans. Microw. Theory Techn.*, vol. MTT-33, no. 3, pp. 271–274, Mar. 1985.



Bahram Yassini (S'89–M'02) received the M.A.Sc. degree in electrical engineering from the University of Waterloo, Waterloo, ON, Canada, in 2001.

In 2001, he joined COM DEV Ltd., Cambridge, ON, Canada, where he is currently a Principal Member of Technical Staff with the Research and Development Department. His work includes design, analysis, and modeling of RF/microwave filters and components, switches, and interconnect circuits for ground and space applications. Prior to that, he was with Algorex Canada, where he was involved

with RF/wireless channel modeling as an RF Engineer; Italtel SPA, where he was involved with digital radio networks as a Senior Technical Advisor; and MATN, where he was involved with wireless and satellite communication systems as a Senior Radio System Engineer. He holds two patents.

Mr. Yassini was the recipient of two 2010 COM DEV R&D Awards for the development of a tunable filter and a high-power filter for space applications.



Ming Yu (S'90–M'93–SM'01–F'09) received the Ph.D. degree in electrical engineering from the University of Victoria, Victoria, BC, Canada, in 1995.

In 1993, while working on his doctoral dissertation part time, he joined COM DEV Ltd., Cambridge, ON, Canada, as a Member of Technical Staff, where he was involved in the design of passive microwave/RF hardware or both space- and ground-based applications. He was also a principal developer of a variety of COM DEV Ltd.'s core design and tuning software

for microwave filters and multiplexers, including computer-aided tuning software in 1994 and a fully automated robotic diplexer tuning system in 1999. His varied experience also includes being the Manager of Filter/Multiplexer Technology (Space Group) and Staff Scientist of Corporate Research and Development (R&D). He is currently the Chief Scientist and Director of R&D with COM DEV Ltd., where he is responsible for overseeing the development of company R&D Roadmap and next-generation products and technologies including high-frequency and high-power engineering, electromagnetic-based computer-aided design (CAD) and tuning for complex and large problems, and novel miniaturization techniques for microwave networks. He is also an Adjunct Professor with the University of Waterloo, ON, Canada. He has authored or coauthored over 100 publications and numerous proprietary reports. He holds 10 patents with 4 pending.

Dr. Yu is an IEEE Microwave Theory and Techniques Society (IEEE MTT-S) Distinguished Microwave Lecturer from 2010 to 2012. He has been an IEEE MTT-S Filter Committee chair (MTT-8) since 2010 and also serves as chair of TPC-11. He was an associate editor for the IEEE TRANSACTIONS ON MICROWAVE THEORY AND TECHNIQUES. In 2015, he became a Fellow of the Canadian Academy of Engineering. He was the recipient of the 1995 and 2006 COM DEV Achievement Award for the development a computer-aided tuning algorithms and systems for microwave filters and multiplexers. He holds a Natural Sciences and Engineering Research Council (NSERC) Discovery Grant with the University of Waterloo (2004–2015).