

# Predistortion Technique for Cross-Coupled Filters and Its Application to Satellite Communication Systems

Ming Yu, *Senior Member, IEEE*, Wai-Cheung Tang, Alastair Malarky, Van Dokas, Richard Cameron, *Fellow, IEEE*, and Ying Wang

**Abstract**—This paper presents a novel adaptive predistortion technique for general cross-coupled microwave/RF filters with improved insertion loss and group-delay equalization. The method enables many potential applications of an almost abandoned technique, and permits a lower  $Q$  implementation technology to emulate the performance of a higher  $Q$  filter. 10–4–4 filters were built and tested at  $C$ - and  $Ku$ -band to verify the validity of the new method. The impact to satellite communication channels was also analyzed. Another novel concept of over-predistortion was proposed and evaluated and should lead to significant improvement for applications such as satellite transponder input multiplexers, where insertion loss can be traded off for in-band flatness, mass, volume, and even overall system performance.

**Index Terms**—Computer-aided design (CAD), microwave filters and multiplexers, satellite communication, transfer functions.

## I. INTRODUCTION

CROSS-COUPLED microwave and RF filters are used in various communications systems, particularly communications satellites, earth stations, wireless base-stations, and repeaters. This filter class is considered as the most general form of filter structure. The filter design is usually a tradeoff between parameters such as insertion loss, loss variation, group delay, isolation, physical dimensions, and mass. The approach to the design of microwave filters using different functions is expressed often in polynomial form and is well documented [1]. Once the material and type of resonator are chosen, the quality factor ( $Q$ ) is set. In order to increase the  $Q$ , one often must increase the size of the resonator cavities, resulting in a larger and heavier filter. This may not always be practical due to overall design constraints driven primarily by the application. The finite  $Q$  (highest possible value selected after the tradeoff between size and performance is made) will translate to energy dissipation in the filter and, hence, insertion loss. The filter will also exhibit finite band-edge sharpness related to the particular  $Q$  value.

In order to improve the parameters such as loss variation without resorting to an increase in size and mass, an approach using a predistortion technique can be used. In the area of microwave filter design, the concept was first proposed by Livingston [2] and later described in more detail by Williams *et al.* [3] for cross-coupled microwave filters (with nonadjacent

cavity couplings to realize transmission zeros). It is noted that they both used it to predistort a relatively high  $Q$  filter and that their approach did not change the size and weight of the filter and, therefore, did not translate to any subsequent reduction in volume and mass. The goal of their contribution was to enhance the filter performance (loss variation) by emulating even much higher  $Q$ . In [3], the filters used before predistortion exhibit a  $Q$  of 8000 (both waveguide and dielectric resonators), which, today, still somewhat represents the state-of-art in satellite communication systems (thus considered as high  $Q$ ).

In the previous predistortion techniques [2], [3], the key to predistortion is to move the transmission poles (of the filter function) toward the  $j\omega$  axis by a “fixed amount.” This can flatten the loss variation, but only at the severe expense of insertion and return losses. To the best of our knowledge, since the last publication in 1985 [3], there are no other known publications on this subject in the microwave engineering community. We also are not aware of any commercial application utilizing this technique. We believe that the main reasons are that the technique appeared to be limited to improving already high- $Q$  filters since, otherwise, the insertion loss would be too severe for most practical communication systems to absorb, the technique had relatively little flexibility, and tuning such filters would be problematic. To the best of our knowledge, a low- $Q$  design approach using predistortion has never been attempted, and no techniques with the flexibility of the technique reported here have been demonstrated. We note that, today, with the advances in computer-aided tuning techniques, the tuning problem is of lesser concern. Another drawback recognized by [2] and [3] is that, in modern satellite communication applications, group-delay equalization is often incorporated in the design process of a filter. The simple predistortion technique disclosed in [2] and [3] inherently leads to undesirable increase in the group delay of such filters.

High- $Q$  filters are often used in the input multiplexer (IMUX) assemblies of communication satellite transponders. Today, most  $C$ - and  $Ku$ -band IMUX filters are based on either single- or dual-mode dielectric-resonator technology. While dual-mode filters are slightly smaller and lighter than their single-mode counterpart, the single-mode filter offers better performance over the dual mode in the following areas:

- higher realizable  $Q$ ;
- no cross-polarization stray coupling (common in a dual-mode filter), leading to the ease of tuning for complex filter transfer functions;
- more compact packaging due to the single mode planar layout.

Manuscript received April 17, 2003.

M. Yu, W.-C. Tang, A. Malarky, V. Dokas, and Y. Wang are with COM DEV, Cambridge, ON, Canada N1R 7H6 (e-mail: Ming.Yu@comdev.ca).

R. Cameron is with COM DEV Europe, Aylesbury HP22-5SX, U.K.

Digital Object Identifier 10.1109/TMTT.2003.820172

In particular, the ease of tuning makes possible the use of temperature-stable self-equalized 10–4–4 (ten pole, four  $j\omega$  axis zeros, four real or complex zeros) filters over the conventional 8–4 externally equalized filters commonly used in the dual-mode case.

The most critical electrical parameters for an IMUX filter are in-band performance such as loss variation and group delay. From a physical perspective, mass and volume are also very critical considerations. The absolute insertion loss in the band center is often a secondary parameter that can be traded off. An IMUX is incorporated in the payload after the low-noise amplifiers (LNAs), which are part of the RF receiver and prior to the channel amplifiers. The gain of the LNAs and/or channel amplifiers is programmable in most satellites and, by setting the gain to a higher value, the insertion loss increase associated with the predistortion technique can be recovered. The IMUX loss, as long as it is not excessive, has no impact on the satellite G/T (the ratio of the antenna gain (G) of the receiver and the system noise temperature (T), figure-of-merit for receiving equipment). In searching for the next technology advancement for the IMUX filter, we set the goal to reduce the mass and volume of the single-mode dielectric filter while preserving the advantages and attributes of single-mode dielectric-resonator filters. It is well known that the size and mass of filters are driven by the  $Q$  required. In order to reduce the size, we needed to find ways to use low- $Q$  resonators and make them behave like high- $Q$  resonators. This contribution makes full use of the possibility of insertion loss tradeoff by applying a novel predistortion technique to a very low  $Q$  filter ( $<3000$ ). This approach not only improves the performance of the loss variation (with much smaller insertion loss penalty), but also reduces the size and mass significantly.

In this paper, we demonstrate the feasibility of predistorted IMUX filters that can achieve an equivalent  $Q$  of  $>20\,000$ , while providing a more than 3 : 1 reduction in mass and volume over the current  $C$ -band single-mode dielectric-resonator filters, yet only introducing an additional 4-dB insertion loss. We also show that the same approach can be applied to  $Ku$ -band filters to improve filter performance. More importantly, we will also show that the adaptive predistortion is not limited to simply achieving an effective higher  $Q$  filter, but can improve the overall channel throughput by increasing the usable passband, both amplitude and group delay, of the transponder.

## II. THEORY OF ADAPTIVE PREDISTORTION [4]

In [3], the stated key to predistortion was to move the transmission poles (of the filter function) toward the  $j\omega$  axis by a “fixed amount” denoted  $r$  [3, p. 402, eq. (4); p. 403, Fig. 2]). To illustrate the use of this, let us examine the following key formula of the design process:

$$S_{21} = \frac{D(s)}{E(s)} \quad (1)$$

where  $S_{21}$  is a measure of amplitude and phase of the output signal relative to the input signal,  $s = j\omega$ ,  $\omega$  is the angular frequency,  $r = CF/Q \times BW$ ,  $CF$  is the center frequency, and  $BW$

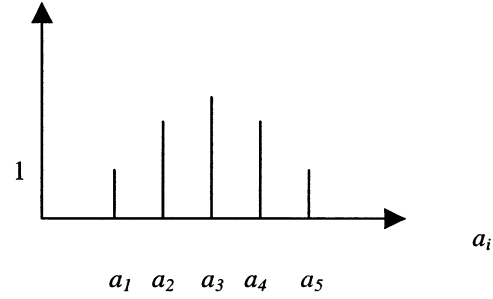

Fig. 1. Piecewise sinusoidal function.

is the bandwidth. The filter design process generally involves realizing the poles and zeros of a rational function  $S_{21}$ . The transmission poles are the roots of polynomial  $E(s)$  [1]

$$E(s) = c(s - p_1)(s - p_2) \dots (s - p_n) \quad (2)$$

where  $c$  is a constant and  $p_i$  is the  $i$ th root of  $E(s)$ .

When loss is modeled using the notion of dissipation factor  $r$  [3],  $E(s)$  takes the form

$$E(s) = c[s - (p_1 - r)] \dots [s - (p_n - r)]. \quad (3)$$

The technique proposed in [3], therefore, introduced a constant shift of  $r$  in all the values  $p_i$  to combat the effect of dissipation factor in the transmission poles.

In contrast, the adaptive predistortion approach reported here is realized by introducing adaptive correction terms  $a_i$  ( $i = 1, 2, \dots, n$ ) so that when including dissipation factor  $r$ ,  $E(s)$  take the form

$$E(s) = c[s - (p_1 - r + a_1)] \dots [s - (p_n - r + a_n)]. \quad (4)$$

$a_i$  is an arbitrary term that can be virtually anything as long as the law that governs physical realizability is not broken, i.e., keep all zeros of  $E(s)$  in the left half of complex plane, vis.

$$\text{real}[p_i - r + a_i] < 0. \quad (5)$$

Without loss of generality,  $a_i$  is chosen to have a piecewise sinusoidal (shaped) function, as shown in Fig. 1 (shown as  $n = 5$ ).  $a_1$  and  $a_n$  typically correspond to the poles ( $p$ ) next to the  $j\omega$  axis. The starting value of  $a_i$  can be

$$a_i = 0.1r \sin \left[ \frac{(i-1)\pi}{2(n-1)} \right]. \quad (6)$$

$a_i$  is adjusted by the optimization algorithm to adapt into different filter functions. By using a piecewise sinusoidal function, we can ensure all  $a_i$  is changed at a difference pace, but adapts to the filter functions and specifications. This is a general form of mathematical expression to represent any shape. The method in [3] then becomes a special case when all  $a_i$  are the same, i.e.,  $a_i = a$ .  $a$  is often called the predistortion term. If desired  $Q$  value after predistortion is  $Q_p$ , then we obtain

$$a = \frac{CF}{BW} \left( \frac{1}{Q} - \frac{1}{Q_p} \right). \quad (7)$$

TABLE I  
CASE STUDY

Parameters (dB)	Adaptive Predistortion	Predistortion [3]
Insertion loss	-5.0	-6.9
Return Loss	-3.6	-2.0

In general,  $a_i$  can be expressed using  $a$  as

$$a_i = v_i a \quad (8)$$

where  $v_i$  is defined as the adaptive factor or in vector form  $\vec{v}$ .  $v_i = 1$  is a special case for the method in [3]. The filter response, denoted herein as  $F(s)$ , can be calculated once again per [1] and [3]. The filter response requirement (including shape and specifications) can be also defined as a function  $R(s)$ . An optimization method such as least square is then used to minimize

$$\min |F(s) - R(s)| \quad (9)$$

by adjusting  $a_i$  under the restriction condition of (5). A new set of roots of  $E(s)$  is obtained as

$$t_i = p_i - a_i. \quad (10)$$

The final filter function then takes the form of

$$S_{21}(s) = \frac{D(s)}{E'(s)} \quad (11)$$

where

$$E'(s) = c(s - t_1)(s - t_2) \cdots (s - t_n). \quad (12)$$

Note that, through this process, no change has occurred in the transmission zeros  $[D(s)]$  in (1).

This adaptive predistortion technique will result in much less insertion loss despite using low- $Q$  resonators, while other parameters such as loss variation will also be better than [2] and [3]. The small increase in group-delay ripple (when using [3] for a self-equalized filter) can also be fixed adaptively. In one example, we analyzed a tenth-order filter typically used for satellite communications. The resonator used has a  $Q$  of 3000. The target was to get equivalent performance of a filter with  $Q$  of 8000. The adaptive vector is  $\vec{v} = [0.7 \ 1 \ \cdots \ 1 \ 0.7]$ . The first and last elements are corresponding to the poles near the  $j\omega$  axis. The rest of the element values are all one. The results are given in Table I.

One may notice there is a 1.9-dB improvement in insertion loss and 1.6-dB improvement in return loss. Although using any type of predistortion technique always leads to some level of insertion-loss penalty, it is always very desirable to minimize the extra insertion loss. As one can see from Table I, using the technique of [2] and [3] will lead to an additional 5.9-dB insertion loss in a low- $Q$  filter using predistortion. On the other hand, using the proposed method will result in only 4-dB loss in addition to a conventional dielectric-resonator filter, which has an insertion loss of approximately 1.0 dB. This improvement is very significant, as it could lead to direct “drop-in”-type replacement of the current IMUX systems. The increase in LNA gain is within

the range of adjustability of the amplifiers and may not require redesign to increase their gain (an extra stage).

In addition, the adaptive approach suggests that some of the elements of  $\vec{v}$  can be bigger than one, while some of them are smaller than one. That implies some of the poles can be “over-predistorted,” while the poles near the  $j\omega$  axis are “under-predistorted” to achieve the best overall results. This approach is necessary when much higher  $Q$  is required after predistortion. In Section III, we will demonstrate how this concept will be applied to achieve a target  $Q$  of 20 000.

### III. FILTER REALIZATION AT $C$ -BAND

One of the main objectives for developing the predistorted filter is to reduce the mass and volume over the current  $C$ -band single-mode dielectric resonator used. The standard coaxial cavity resonator was selected for its simplicity, good  $Q$  to volume ratio given its compact size, simple temperature compensation leading to excellent temperature stability, and ability to be readily qualified by similarity with past coaxial flight hardware. Using a typical  $C$ -band filter of 1% bandwidth and a ten-pole self-equalized transfer-function design, a series of simulations were performed to determine the optimal tradeoff between cavity size and insertion loss with a targeted equivalent  $Q$  of 20 000, where “equivalent  $Q$ ” means the filter transmission response, except absolute insertion loss, is comparable to a filter implemented at that  $Q$  level. The result of the tradeoff is shown in Table II.

To realize a 10–4–4 filter [1] using the optimization procedure given in the previous section, the following eight transmission zeros are chosen (return-loss level set at 22 dB):

$$\begin{aligned} &\pm 1.09912j \\ &\pm 1.605389j \\ &\pm 0.61730 \pm 0.34881j. \end{aligned}$$

Following the process defined in the previous section, a solution of  $\vec{v} = [0.4 \ 1.5 \ \cdots \ 1.5 \ 0.4]$  is selected. That means the poles near the  $j\omega$  axis are moved (under-predistorted) 0.4 times less than the standard predistortion [3] and all other poles are moved 1.5 times more (over-predistorted). The adaptively predistorted poles now sit at

$$\begin{aligned} &- 0.020300 \pm 1.030902j \\ &- 0.097168 \pm 0.972767j \\ &- 0.225218 \pm 0.750657j \\ &- 0.252744 \pm 0.445003j \\ &- 0.263617 \pm 0.155519j. \end{aligned}$$

TABLE II  
INSERTION LOSS VERSUS INTRINSIC  $Q$  FOR AN EQUIVALENT  $Q$  OF 20000

Intrinsic $Q$	Cavity size in inches	Insertion loss in dB	
		before Predistortion	after Predistortion
1000	0.15 x 0.15 x 0.8	7.7	24.7
2000	0.3 x 0.3 x 0.75	3.9	10.4
<b>3000</b>	<b>0.5 x 0.5 x 0.7</b>	<b>2.6</b>	<b>5.7</b>
4000	0.7 x 0.7 x 0.62	1.9	3.9
5000	1.0 x 1.0 x 0.5	1.6	2.9

The coupling matrix derived [1] through this process is presented in the equation at the bottom of this page. It is also interesting to point out that the reflection zeros ( $S_{11}$ ) will no longer be on the  $j\omega$  axis as follows:

$$\begin{aligned}
 & -0.000000 \pm 1.018419j \\
 & -0.071729 \pm 0.967019j \\
 & -0.197336 \pm 0.745597j \\
 & -0.222897 \pm 0.443401j \\
 & -0.232933 \pm 0.154880j.
 \end{aligned}$$

A low-cost coaxial resonator structure (compline) using  $0.5 \times 0.5 \times 0.7$  in cavities was selected to construct the low- $Q$  ( $Q = 3000$ ) filter [4], [5], resulting in an overall filter dimension of  $1.1 \times 3.0 \times 0.9$  in for a ten-pole design. The length of the post inside a cavity is approximately 0.6 in, which leaves a gap of 0.1 in. The filter housing is fabricated using aluminum for low mass, except part of the coaxial posts (0.3 in) was made out of Invar for temperature compensation. The filter is shown in a side-by-side comparison to a typical dielectric-resonator filter in Fig. 2(a). The internal structure of the coaxial filter is shown in Fig. 2(b). An extra coupling probe ( $M_{47}$ ) was added to cancel the dispersion and stray coupling effect of the filter so a balanced isolation response can be achieved. The center frequency is 3.952 GHz and bandwidth is approximately 39 MHz. The larger filter with a  $Q$  of 8000 represents what is currently being used for input multiplexers in satellite transponders. Both filters are of the same frequency and order. The volume of the smaller coaxial filter is approximately 25% of the larger dielectric filter with a

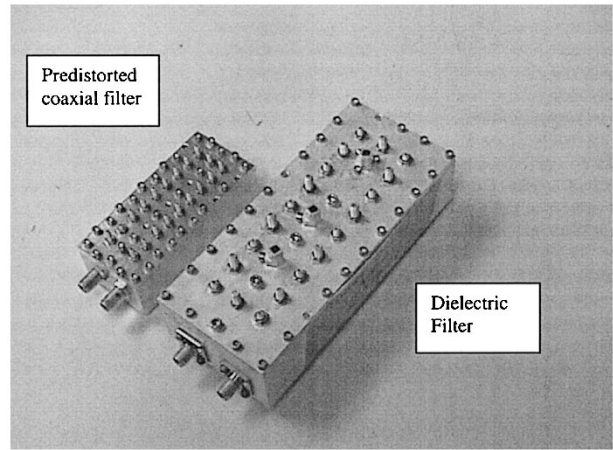

(a)

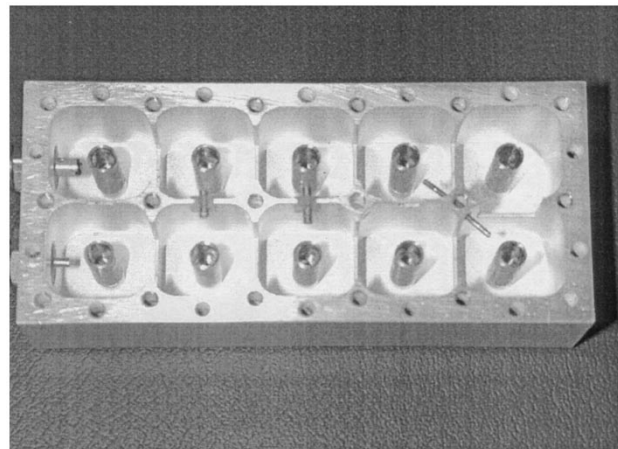

(b)

Fig. 2. (a) Coaxial resonator predistorted and a conventional dielectric-resonator filter. (b) Predistorted coaxial resonator filter without a lid.

corresponding mass reduction of about 65%. The predistorted filter is designed to have a  $Q$  of 20000 with insertion of 5.7 dB. The size of the filter is almost comparable to the typical  $Ku$ -band dielectric IMUX filter, as shown in Section IV.

The measured performance of the adaptively predistorted filter is shown in Fig. 3(a)–(c). Both loss variation and isolation plots in Fig. 3(a) and (b) are normalized to 5.9 dB (which is measured insertion loss compared with the designed value of 5.7 dB). The in-band insertion-loss variation is less than 0.1 dB

$$R1 = 0.1307, Rn = 1.5800$$

0.00000	0.70514	0.00000	0.00000	0.00000	0.00000	0.00000	0.00000	0.00000	0.01434
0.70514	0.00000	0.54767	0.00000	0.00000	0.00000	0.00000	0.00000	-0.01999	0.00000
0.00000	0.54767	0.00000	0.49894	0.00000	0.00000	0.00000	-0.8992	0.00000	0.00000
0.00000	0.00000	0.49894	0.00000	0.49391	0.00000	-0.00369	0.00000	0.00000	0.00000
0.00000	0.00000	0.00000	0.49391	0.00000	0.62432	0.00000	0.00000	0.00000	0.00000
0.00000	0.00000	0.00000	0.00000	0.62432	0.0001	0.53824	0.00000	0.00000	0.00000
0.00000	0.00000	0.00000	-0.00369	0.00000	0.53824	0.00000	0.56020	0.00000	0.00000
0.00000	0.00000	-0.8992	0.00000	0.00000	0.00000	0.56020	0.00000	0.64935	0.00000
0.00000	-0.01999	0.00000	0.00000	0.00000	0.00000	0.00000	0.64935	0.00000	1.07017
0.01434	0.00000	0.00000	0.00000	0.00000	0.00000	0.00000	0.00000	1.07017	0.00000

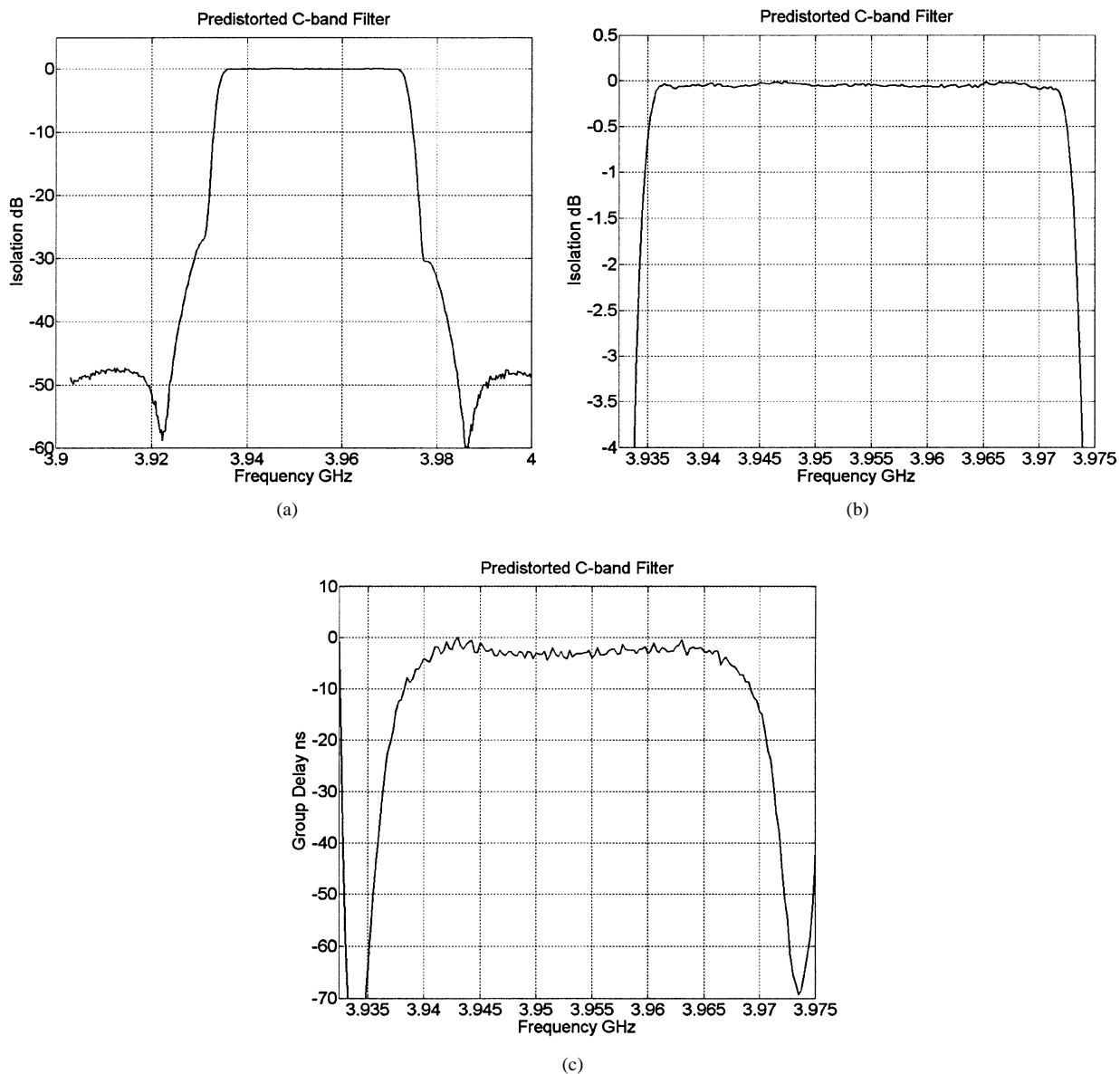

Fig. 3. (a) Measured isolation performance. (b) Measured loss variation performance. (c) Measured group-delay performance.

and the in-band group delay is less than 2 ns. To estimate the equivalent  $Q$ , the measured loss variation is compared to the computer-simulated performance. In Fig. 4, we present the comparison between the measured performance and simulations using ideal  $Q$ . From this comparison, the equivalent  $Q$  of the measured filter is estimated to be above 20 000. This set of measured data clearly confirms that, by implementing the adaptive predistortion technique, the performance of a low  $Q$  coaxial filter as a minimum is comparable (group delay) to or significantly better (loss variation) than a high- $Q$  dielectric filter. A much higher equivalent  $Q$  can be easily realized using this approach. The method can also be used for high  $Q$  filters although the advantage would be less impressive. The designed filter was also tested for stability and drift over temperature. Less than 0.5 ppm frequency drift was observed over 40 °C. (Both insertion loss and isolation are the magnitude of  $S_{21}$ . Both terms were used in this paper to focus on in-band or out-of-band performance.)

#### IV. FILTER REALIZATION AT $Ku$ -BAND

$Ku$ -band IMUX filters often have the similar bandwidth to their  $C$ -band counterparts, which means that the proportional bandwidth is approximately three times narrower than at  $C$ -band. In order to achieve the comparable results at  $Ku$ -band, the starting  $Q$  for  $Ku$ -band resonators needs to be around 9000. This limitation pretty much rules out the possibilities of using inexpensive coaxial filter technology to replace current dielectric technology. On the other hand, the much improved in-band performance with adaptively predistorted filters still justifies development of a  $Ku$ -band version using dielectric-resonator technology. In addition, we will also show that other bandwidth enhancement features can also be achieved by extending the adaptive approach. This will become more obvious in Section V.

Dielectric loaded resonators ( $Q = 8000$ ) using  $0.4 \times 0.4 \times 0.35$  in cavities were selected to construct the  $Ku$ -band filter. The 10-4-4 filter using the  $TE_{01\delta}$  mode is

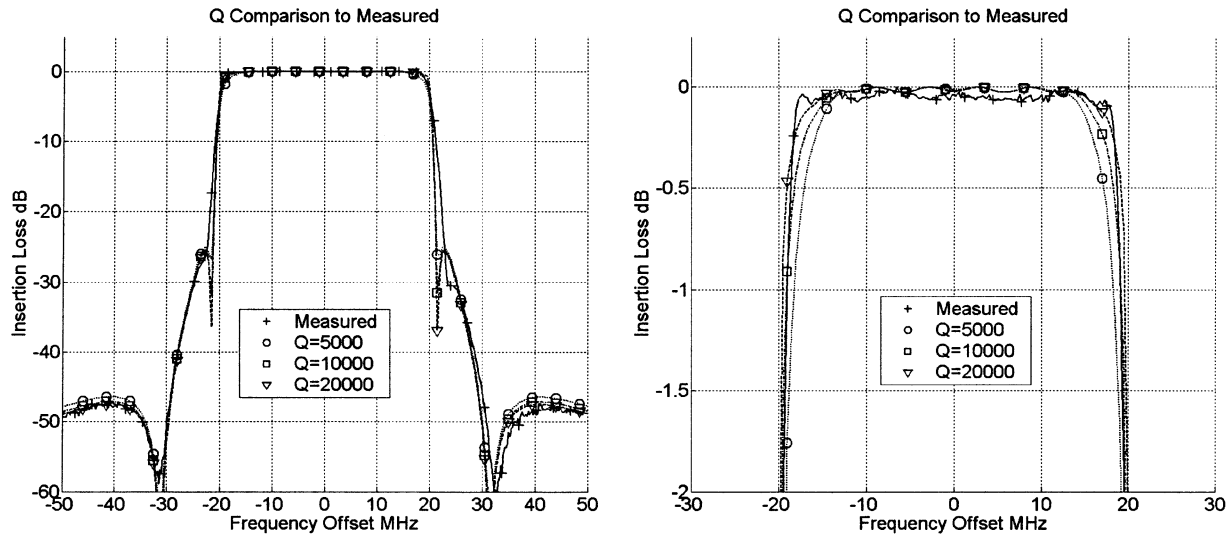

Fig. 4. Measured loss versus simulated with ideal  $Q$ .

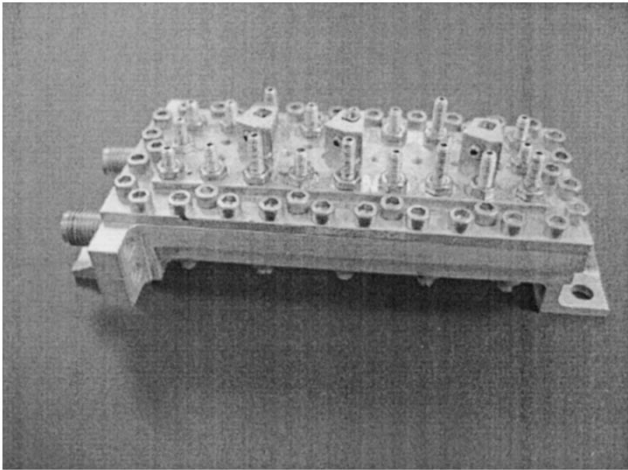

Fig. 5. Predistorted dielectric-resonator filter at  $Ku$ -band.

shown in Fig. 5. There are no structural differences from the commonly used  $Ku$ -band IMUX filter, except the internal iris/probe sizes. The center frequency is 12.65 GHz and the bandwidth is approximately 50 MHz. The (preliminary) measured performance of the adaptively predistorted filter is shown in Fig. 6(a)–(c) and is consistent with an equivalent  $Q$  of 20 000. The research is still on going and more results will be reported later.

## V. TRANSPONDER BANDWIDTH ENHANCEMENT

It is well known that lower  $Q$  results in rounding of the filter passband, especially for low fractional bandwidth filters. Our research has indicated that adaptive predistortion can also be used to shape the IMUX filter to complement and, hence, compensate the output multiplexer (OMUX) passband response, without compromising the channel performance constraints, especially isolation. However, this is only practical with proposed adaptive predistortion techniques combined with computer-aided tuning to facilitate manufacturing.

Let us take a look of a typical satellite communication system (simplified) using a series of filters, as shown in Fig. 7 [6]. The predistorted filter discussed in Sections II–IV will be used as the first filter (IMUX) after the uplink antenna and the receiver (RCVR).

Since the second filter (OMUX) is a high-power device for downlink communication, predistortion techniques discussed or in any other form could not be used since any extra insertion loss introduced by predistortion will cause significant power loss, dissipation, and reduction in satellite effective isotropic radiated power (EIRP). The OMUX is often realized using a fourth- or fifth-order filter [7] with one pair of transmission zeros.

In order to improve the overall system performance, a new technique is proposed, which uses exactly the same steps as given in (1)–(12), except modifying (9) and instead: 1) calculating the filter response  $F(s)$  by cascading the  $s$ -parameter matrix of IMUX with the  $s$ -parameter matrix of Filter 2 (OMUX, a constant matrix) and 2) setting the response  $R(s)$  to the overall channel requirement.

Based on the information of the OMUX filter, an estimate is made of the transfer function of the overcompensated adaptively predistorted IMUX filter to achieve the desired performance criteria of the combined filters (i.e., the system). The poles of the estimated transfer function of the (overcompensated) adaptively predistorted IMUX filter are calculated; these poles are adaptively predistorted so that at least one pole is shifted by a unique amount. Computer optimization is then preferably used to minimize the difference transfer function. The end result is that the poles of the overcompensated adaptively predistorted filter are shifted until the product transfer function is sufficiently close to the desired transfer function (i.e., the difference transfer function is preferably minimized).

This will lead to so-called over-predistortion of the IMUX, but the overall performance of the combined filter network is significantly improved. This is also called OMUX matching.

To validate this concept, optimization criteria were developed and simulations have been carried out on a number of fractional

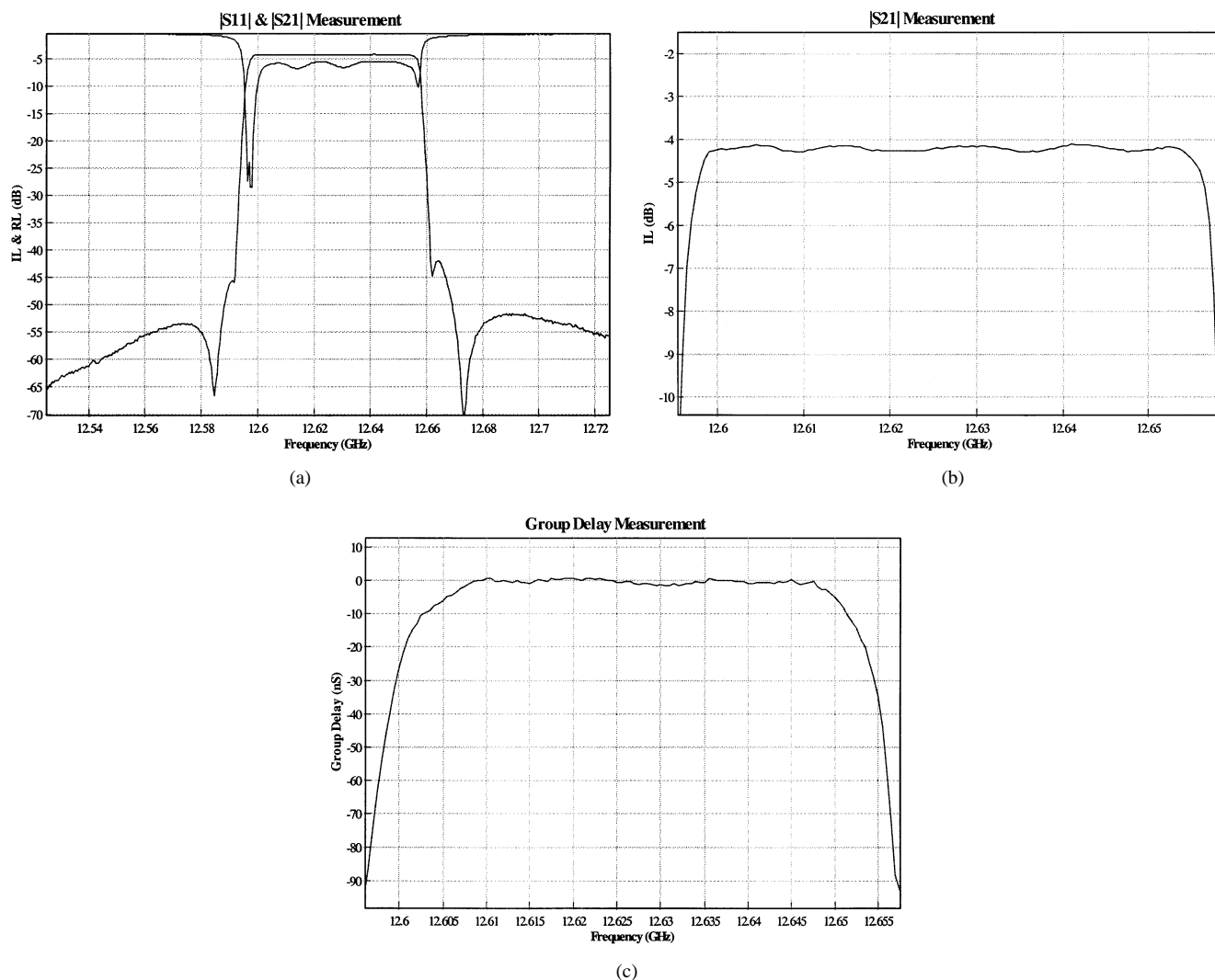

Fig. 6. (a) Measured return loss and isolation performance. (b) Measured loss variation performance. (c) Measured group-delay performance.

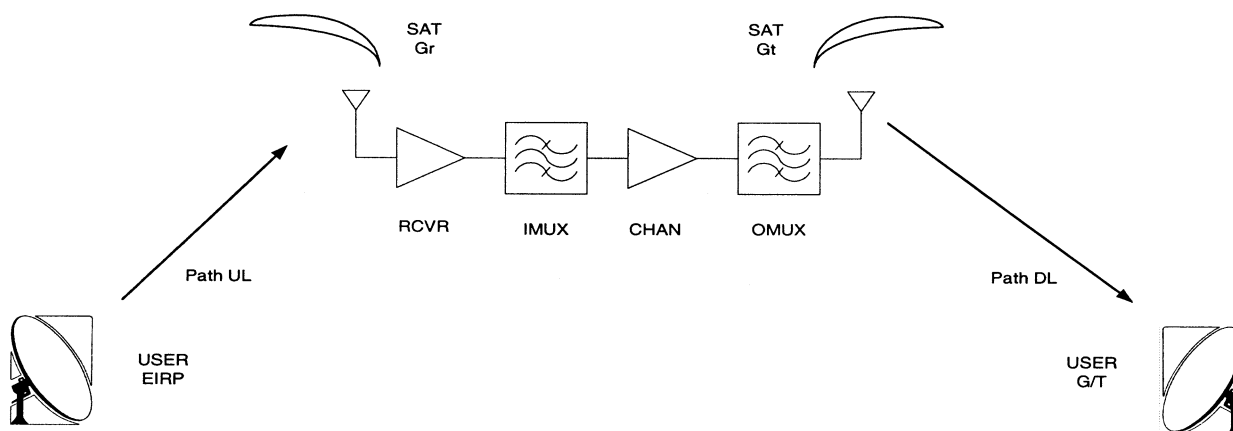

Fig. 7. Simplified satellite communication system.

filter bandwidths to quantify the achievable transponder bandwidth enhancement.

Fig. 8 shows the current technology amplitude responses of 27-MHz *Ku*-band IMUX and OMUX filters and the combined channel response. It can clearly be seen that in a multicarrier application, users transmitting near the band edge of the channel

are disadvantaged by the variation in satellite transponder gain, and the IMUX response is a significant contributor to the reduced gain.

Fig. 9 shows the effect for two predistortion cases, first, when the IMUX  $Q$  is increased from the standard dielectric-resonator value of 8000 (minimum over temperature) to an effective  $Q$

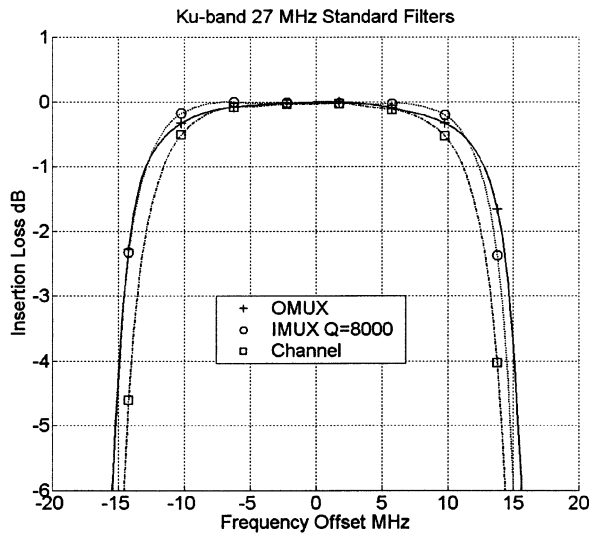

Fig. 8. Standard *Ku*-band 27-MHz filter passband.

of 20 000, as previously described, and second, when the same IMUX is adaptively predistorted to match the OMUX and optimize the transponder channel amplitude response, while constraining the maximum insertion loss to match the effective  $Q$  case. It is clear that the OMUX matching predistortion technique can significantly enhance the transponder gain response.

To generalize the improvement impact, we removed the dependence on operating frequency by normalizing to a fractional bandwidth. Simulations were performed over a range of fractional bandwidths and similarly to show bandwidth improvements. Fig. 10 shows the percentage bandwidth improvement achievable versus fractional bandwidth at different passband loss variation levels, while Fig. 11 shows the IMUX insertion loss for the different combinations.

Note that, by using the adaptive predistortion technique, the amount of bandwidth improvement can be traded against the insertion-loss penalty by adjusting the optimization criteria.

Finally, we observe that OMUX matching with adaptive predistortion not only improves the channel amplitude response, but also the channel group-delay response. This is because the adaptive predistortion allows independent control and optimization of amplitude and group delay simultaneously. Fig. 12 shows a comparison between the 27-MHz channel group delays for the standard filter, the filter with  $Q$  enhanced to 20 000, and the filter adaptively matched to the OMUX.

For 27-MHz channel bandwidths at *Ku*-band, such as those used in the Anik F series of spacecrafts, the increase in usable transponder bandwidth can be as much as 18% at the 1-dB bandwidth point. While the bandwidth advantage is clear in multicarrier applications, transponders are also utilized for full-band single-carrier signals. For this class of signal, the dominant degradation occurs from the group-delay characteristic. One would expect that the passband characteristics of the channel achieved through matching the IMUX to the OMUX will not impair, and may even improve, transponder performance for these signals. However, since the channel matched IMUX has a nonuniform passband response, as shown in Fig. 13, some concern existed that there was potential to cause increased

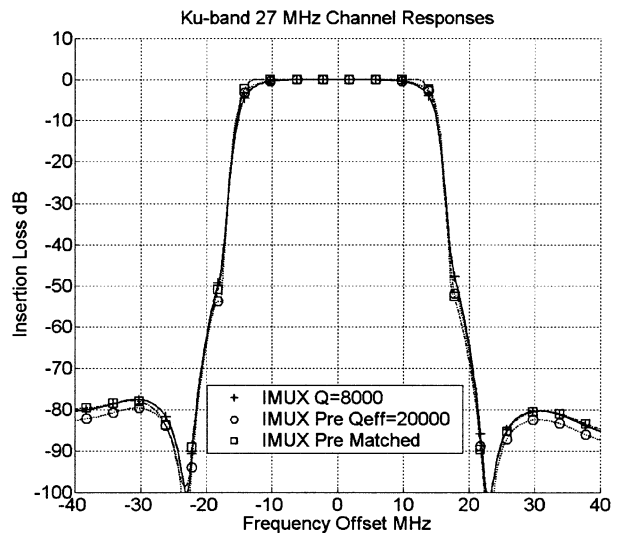

(a)

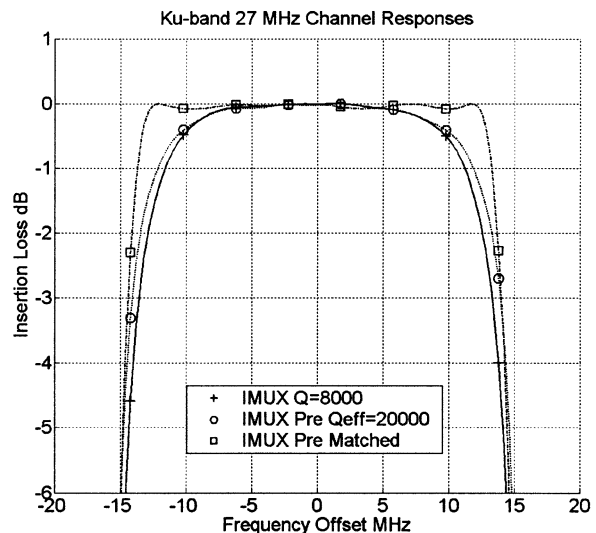

(b)

Fig. 9. (a) Channel (IMUX + OMUX) isolation response for different IMUX selections. (b) Channel (IMUX + OMUX) passband response for different IMUX selections.

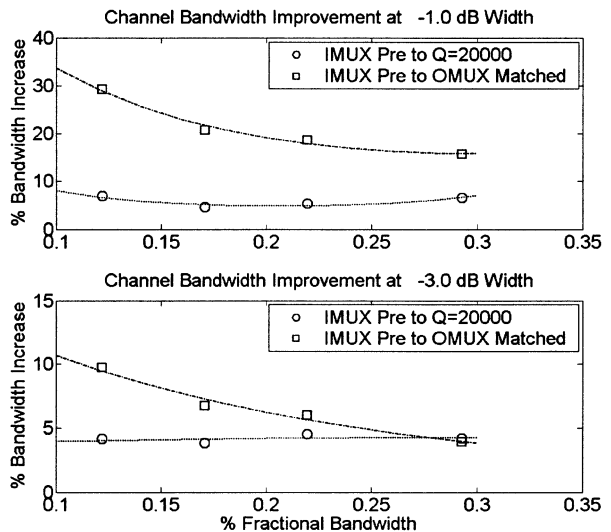

Fig. 10. Transponder bandwidth enhancement versus standard IMUX.



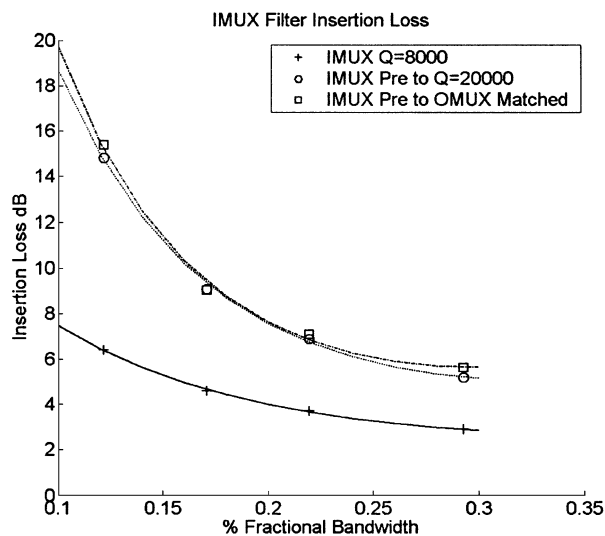

Fig. 11. IMUX insertion loss.

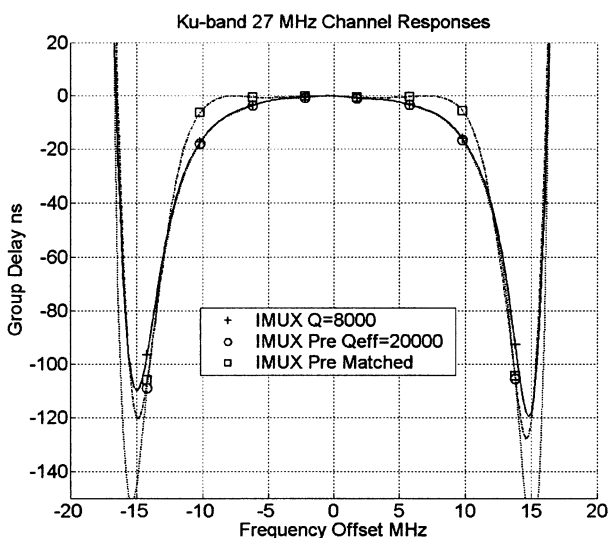
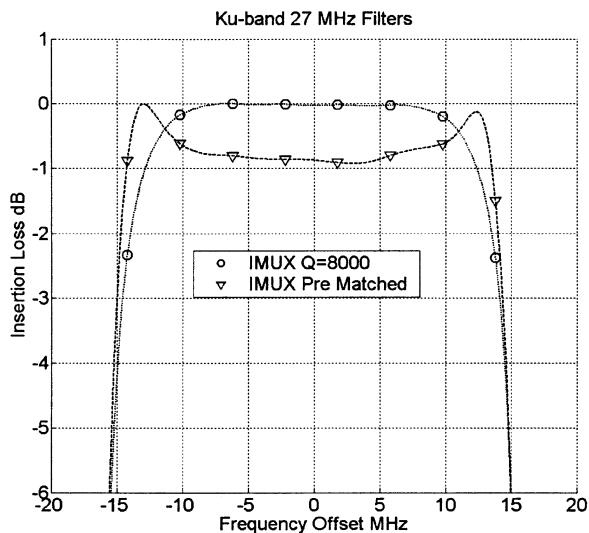

Fig. 12. Channel (IMUX + OMUX) group-delay response for different IMUX selections.

signal distortion in the nonlinear power amplifier and introduce overall channel impairment.

As pointed out in [3], due to the limited return loss (3–5 dB) generated by the predistortion process, circulators must be used with predistorted filters. For IMUX [6] applications, a channel-dropping scheme using circulators is commonly employed, i.e., there are always circulators used before and after channel filters. The multipath effect between the IMUX and OMUX is not of concern since the isolation through the IMUX + OMUX chain is not changed. The multipath effect [6] within the IMUX sub-assembly, caused by the lower return-loss level, is not a real issue since the return loss of conventional IMUX filters without circulators is often not ideal either. The IMUX filter is often tuned into a circulator and its return loss without a circulator can be between 6–15 dB (thus the difference in return loss is small to begin with). The perceived multipath effect is also relieved by using high-quality circulators (>25-dB isolation) and a similar tuning process (matching into circulator and assembly level).



(a)

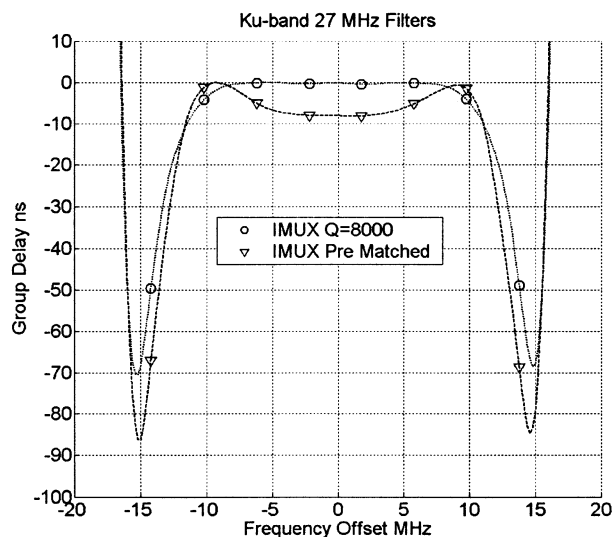

(b)

Fig. 13. (a) IMUX passband loss variation. (b) IMUX passband group-delay variation.

System impact simulations using current generation nonlinear power amplification in combination with the filters have been carried out by Telesat, Ottawa, ON, Canada, and show that the channel matching predistortion does not impair single-carrier performance. At the time of writing this paper, research is ongoing in the analysis of the system performance both at Telesat and at the European Space Agency (ESA), Noordwijk, The Netherlands.

## VI. CONCLUSION

A novel adaptive predistortion technique has been presented and verified through the design and construction of practical ten-pole filters in both *C*- and *Ku*-band. The new method allows the realization of microwave filters at a lower cost, lighter mass, smaller volume, and better performance with minimum insertion-loss penalties. We have clearly shown that the use of predistorted filters for *C*-band and input multiplexer applications represents a significant volume and mass saving of 75%

and 65%, respectively, when compared to the existing dielectric-resonator technology.

We have also shown that predistorted filters can improve the filter loss variation performance at any band to an effective  $Q$  of  $>20\,000$  without sacrificing isolation performance while retaining the significant mass and volume savings at  $C$ -band. At  $Ku$ -band, the adaptive predistortion technique will lead to better performance with the same filter technology.

We have further shown that the adaptive predistortion technique can be used to improve the overall transponder passband response, both in amplitude and group delay. This approach is most effective with narrow-band channels with fractional bandwidths  $<0.5\%$ , as are prevalent at  $Ku$ -band and higher. This response improvement results in significant increases in channel usable bandwidth for frequency-division multiple-access (FDMA) signals; the narrower the channel, the more advantage provided. For 27-MHz channel bandwidths at  $Ku$ -band, such as those used in the Anik F series of spacecraft, the improvement in usable transponder bandwidth can be as much as 18% at the 1-dB bandwidth point, without any degradation in single-carrier performance.

The main penalty in using predistortion is in the increase of insertion loss, however, the increase caused by the adaptive technique is significantly less than the previously reported predistortion technique. Typically, with the adaptive algorithm, an additional loss up to 4–5 dB will be incurred over the conventional high- $Q$  filters currently used. However, since the IMUX is located after the LNA/receiver circuit, one should be able to increase the gain of later stages to compensate for the increase in loss without impacting the noise figure of the system.

The perceived tuning issue from the past is solved using a well-established computer-aided tuning technique. The excellent performance achieved in this paper proves that this technique is ready for practical applications.

The presented technique should lead to significant improvement for applications such as satellite transponder input multiplexers, as well as other systems such as wireless ground base-stations and repeaters, wherever insertion loss can be traded off for in-band flatness, mass, volume, and even overall system performance.

#### ACKNOWLEDGMENT

The authors gratefully acknowledge the insights and system impact simulation support of Dr. A. Smalley, Telesat Canada, Ottawa, ON, Canada, and helpful comments from the reviewers.

#### REFERENCES

- [1] R. J. Cameron, "General prototype network-synthesis methods for microwave filters," *ESA J.*, vol. 6, pp. 193–206, 1982.
- [2] R. M. Livingston, "Predistorted waveguide filters," in *IEEE MTT-S Int. Microwave Symp. Dig.*, 1969, pp. 291–297.
- [3] A. E. Williams, W. G. Bush, and R. R. Bonetti, "Predistortion technique for multicoupled resonator filters," *IEEE Trans. Microwave Theory Tech.*, vol. MTT-33, pp. 402–407, May 1985.
- [4] M. Yu, V. Dokas, W.-C. Tang, and R. Cameron, "Novel adaptive predistortion technique for cross coupled filters," in *IEEE MTT-S Int. Microwave Symp. Dig.*, Philadelphia, PA, June 8–13, 2003, pp. 929–932.

- [5] H. Yao, K. A. Zaki, A. E. Atia, and R. Hershtig, "Full wave modeling of conducting posts in rectangular waveguide and its application to slot coupled combline filters," *IEEE Trans. Microwave Theory Tech.*, vol. 43, pp. 2824–2830, Dec. 1995.
- [6] C. Kudsia, R. Cameron, and W. Tang, "Innovations in microwave filters and multiplexing networks for communication satellite systems," *IEEE Trans. Microwave Theory Tech.*, vol. 40, pp. 1133–1149, June 1992.
- [7] J. Uher, J. Bornemann, and U. Rosenberg, *Waveguide Components for Antenna Feed Systems: Theory and CAD*. Boston, MA: Artech House, 1993.



**Ming Yu** (S'90–M'93–SM'01) received the Ph.D. degree in electrical engineering from the University of Victoria, Victoria, BC, Canada, in 1995.

In 1993, while working on his doctoral dissertation part time, he joined COM DEV, Cambridge, ON, Canada, as a Member of Technical Staff. He was involved in designing passive microwave/RF hardware from 300 MHz to 60 GHz. He was also a principal developer of a variety of COM DEV's proprietary software for microwave filters and multiplexers. His varied experience also includes being the Manager of

Filter/Multiplexer Technology (Space Group) and Staff Scientist of Corporate Research and Development (R&D). He is currently the Director of R&D. He is responsible for overseeing the development of RF microelectromechanical system (MEMS) technology, computer-aided tuning and electromagnetic (EM) modeling and optimization of microwave filters/multiplexers for wireless applications. He is also an Adjunct Associate Professor with the University of Waterloo, Waterloo, ON, Canada. He has authored or coauthored over 30 publications and numerous proprietary reports. He holds two U.S. patents with three pending.

Dr. Yu is a member of the IEEE Technical Coordinating Committee (TCC, MTT-8) and is a frequent reviewer of many IEEE and IEE publications. He was the recipient of the 1995 COM DEV Achievement Award for the development a computer-aided tuning (CAT) system for microwave filters and multiplexers.

**Wai-Cheung Tang**, photograph and biography not available at time of publication.

**Alastair Malarky** was born in 1960. He received the B.Sc. degree in communications and electronic engineering from Napier University, Edinburgh, Scotland, in 1980.

Until 1984, he was with Racal-MESL, Edinburgh, Scotland, where he developed surface-acoustic-wave devices and electronic systems employing them, principally for radar and electronic warfare (EW) applications. In 1984, he joined COM DEV, Cambridge, ON, Canada, as a Senior Member of Technical Staff, where he is involved in the field of electronics and signal processing. He is currently a Staff Scientist reporting to the Vice President of R&D with COM DEV. During his time with COM DEV, he has principally been as a Systems Engineer, including lead roles on a military extremely high-frequency (EHF) Payload Demonstrator, an optical inter-satellite link terminal, and a third-generation (3G) wireless system. His current responsibilities include performing system and technology research studies and providing support to product units and business development.

**Van Dokas** received the Diploma in electronics engineering technology from Conestoga College, Kitchener, ON, Canada, in 1982.

In 1982, he joined COM DEV, Cambridge, ON, Canada, where he was involved with the development of microwave filters and multiplexers for communication satellites. In 1992, he joined the Corporate Research and Development Group, COM DEV, where he was involved in the development of one of the world's first superconducting filters and multiplexers for space- and ground-based wireless applications. His current efforts continue to focus on development of novel microwave passive devices. He has authored or coauthored 13 papers. He holds six patents related to high-temperature superconducting (HTS) and conventional microwave filter design.



**Richard Cameron** (M'83–SM'94–F'02) was born in Glasgow, U.K., in 1947. He received the B.Sc. degree in telecommunications and electronic engineering from Loughborough University, Loughborough, U.K., in 1969.

In 1969, he joined Marconi Space and Defence Systems, Stanmore, U.K. His activities there included small earth-station design, telecommunication satellite system analysis, and computer-aided RF circuit and component design. In 1975, he joined the European Space Agency's technical establishment (ESTEC, The Netherlands), where he was involved in the research and development of advanced microwave active and passive components and circuits, with applications in telecommunications, scientific, and earth observation spacecraft. Since joining COM DEV Europe, Aylesbury, U.K., in 1984, he has been involved in the software and methods for the design of a wide range of high-performance components and subsystems for both space and terrestrial application.

Mr. Cameron is a Fellow of the Institution of Electrical Engineers (IEE), U.K.

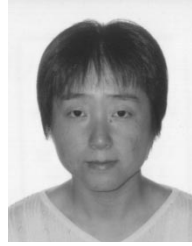

**Ying Wang** received the B. Eng. and M. Eng. degrees in electrical engineering from the Nanjing University of Science and Technology, Nanjing, China, in 1993 and 1996, respectively, and the Ph.D. degree in electrical engineering from the University of Waterloo, Waterloo, ON, Canada, in 2000.

In 2000, she joined COM DEV, Cambridge, ON, Canada, as an Advanced Member of Technical Staff. Since then, she has been involved in development of computer-aided design (CAD) software for the design, simulation, and optimization of microwave circuits for space application.