

CENG4480 Embedded System Development and Applications
The Chinese University of Hong Kong
Laboratory 2: Op Amp (II)

Student ID:

2021 Fall

1 Introduction

This lab session introduces some very basic concepts of operational amplifier “op am” that every engineering student should know about. The op amp IC used in this lab is LM324. LM324 contains 4 op amps, we only use one of them.

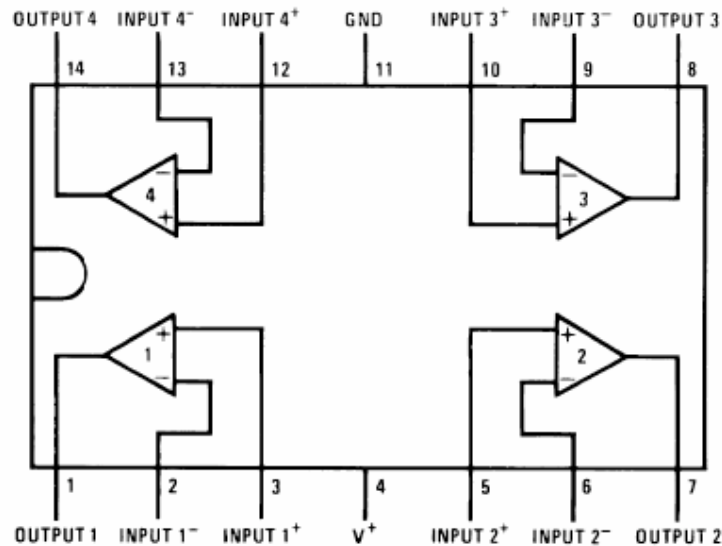

Figure 1: Pinout for the LM324.

Objectives

By completing this lab session, you should know:

- 1 how to use op amp circuits to interface between sensors and MCU;
- 2 how to design amplifier circuit using op amp;
- 3 how to design integrator and differentiator circuit using an op amp.

Procedures

Follow the procedures of each experiment. Write your result in a report sheet with your name and student ID. Submit the report sheet to the tutor after the lab.

2 Experiment Current to Voltage Converter

In this experiment, you will construct and observe the current to voltage converter. Measure the output voltages of the current to voltage converter under different lighting conditions. The following apparatus will be provided:

- 1 a power supply
- 2 an oscilloscope
- 3 a breadboard
- 4 resistors: $2 \times 10K\Omega$, $1 \times 10K$ VR
- 5 an LDR (Light Dependent Resistor)
- 6 one LM324 IC

Procedures

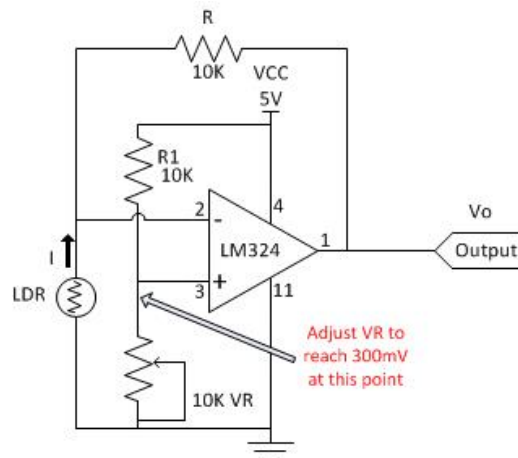

Figure 2: Current to voltage converter.

- 1 Use pinout diagram for LM324 op amp IC shown in Figure 1 to construct the inverting amplifier circuit as shown in Figure 2.
- 2 Connect channel 1 input (X) of the oscilloscope to the output of current to voltage converter.
- 3 Measure the output voltage of current to voltage converter under room lighting condition.
- 4 Measure the output voltage of current to voltage converter without lighting condition (cover the LDR with your hand).
- 5 Verify the equation $V_o = -IR$ (Hint: the resistance of LDR rise when it is covered).

3 Experiment Summing amplifier

In this experiment, you will construct and observe the summing amplifier. Record the input and output waveforms. The following apparatus will be provided:

- 1 a power supply
- 2 an oscilloscope
- 3 a breadboard
- 4 resistors: $3 \times 1K\Omega$
- 5 one LM324 IC

Procedures

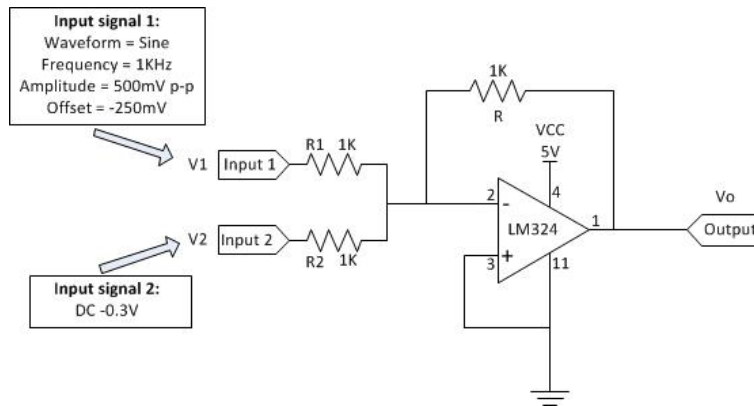

Figure 3: Summing amplifier.

- 1 Use pinout diagram for LM324 op amp IC shown in Figure 1 to construct the summing amplifier circuit as shown in Figure 3.
- 2 Configure the waveform generator on the oscilloscope with following settings:
 - Waveform=Sine
 - Frequency=1KHz
 - Amplitude=500mV p-p
 - Offset=-250mV
- 3 Connect the waveform generator output to the input 1 of summing amplifier.
- 4 Connect -0.3 V dc from power supply (positive connect to GND, negative as the supply output) to the input 2 of summing amplifier.
- 5 Connect channel 1 input (X) of the oscilloscope to the output of summing amplifier and connect channel 2 (Y) input of the oscilloscope to the input 1 of summing amplifier.
- 6 Record the input and output waveforms displayed on the oscilloscope.

7 In your lab report, give your derivation and compare the calculated with measured output voltages. Verify the equation:

$$V_o = - \left\{ \frac{V1}{R1} + \frac{V2}{R2} \right\} R. \quad (1)$$

4 Experiment Op Amp LM324 Slew Rate Measurement

In this experiment, you will construct the inverting amplifier and measure the slew rate of op amp LM324. The following apparatus will be provided:

- 1 a power supply
- 2 an oscilloscope
- 3 a breadboard
- 4 resistors: $2 \times 1K\Omega$
- 5 one LM324 IC

Procedures

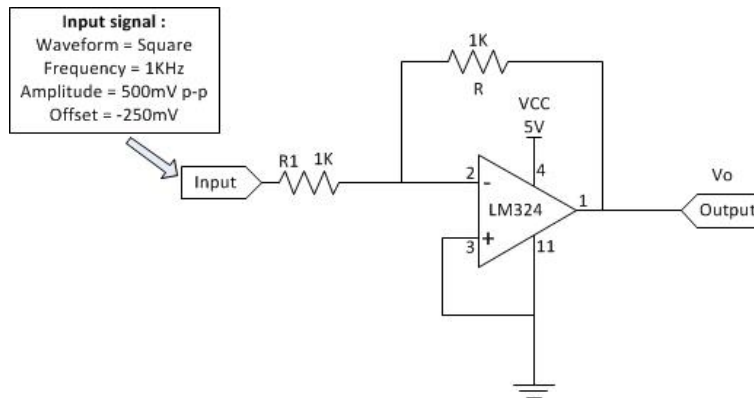

Figure 4: Inverting amplifier.

- 1 Use pinout diagram for LM324 op amp IC shown in Figure 1 to construct the inverting amplifier circuit as shown in Figure 4.
- 2 Configure the waveform generator on the oscilloscope with following settings:
 - Waveform=Square
 - Frequency=1KHz
 - Amplitude=500mV p-p
 - Offset=-250mV
- 3 Connect the waveform generator output to the input of inverting amplifier.

4 Connect channel 1 input (X) of the oscilloscope to the output of inverting amplifier and use Cursor measurement on the oscilloscope to measure Δy and Δx of the rising edge of the output waveform.

5 Calculate the slew rate:

$$\text{Slew rate} = \frac{\Delta y}{\Delta x} \text{ (V}/\mu\text{S)} \quad (2)$$

5 Experiment Integrator

In this experiment, you will construct the integrator and record the output waveform. The following apparatus will be provided:

- 1 a power supply
- 2 an oscilloscope
- 3 a breadboard
- 4 resistors: $2 \times 1K\Omega$
- 5 capacitor: $1 \times 0.1\mu F$
- 6 one LM324 IC

Procedures

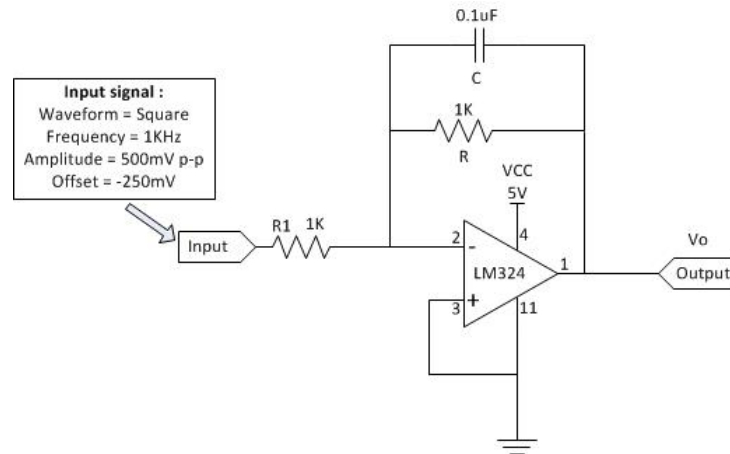

Figure 5: Integrator.

- 1 Use pinout diagram for LM324 op amp IC shown in Figure 1 to construct the integrator circuit as shown in Figure 5.
- 2 Configure the waveform generator on the oscilloscope with following settings:
 - Waveform=Square
 - Frequency=1KHz

- Amplitude= $500mV$ p-p
- Offset= $-250mV$

- 3 Connect the waveform generator output to the input of integrator.
- 4 Connect channel 1 input (X) of the oscilloscope to the output of integrator and connect channel 2 (Y) input of the oscilloscope to the input of integrator.
- 5 Record the input and output waveforms displayed on the oscilloscope.

6 Experiment Differentiator

In this experiment, you will construct the differentiator and record the output waveform. The following apparatus will be provided:

- 1 a power supply
- 2 an oscilloscope
- 3 a breadboard
- 4 resistors: $2 \times 1K\Omega$
- 5 capacitor: $1 \times 0.01\mu F$
- 6 one LM324 IC

Procedures

- 1 Use pinout diagram for LM324 op amp IC shown in Figure 1 to construct the differentiator circuit as shown in Figure 6.

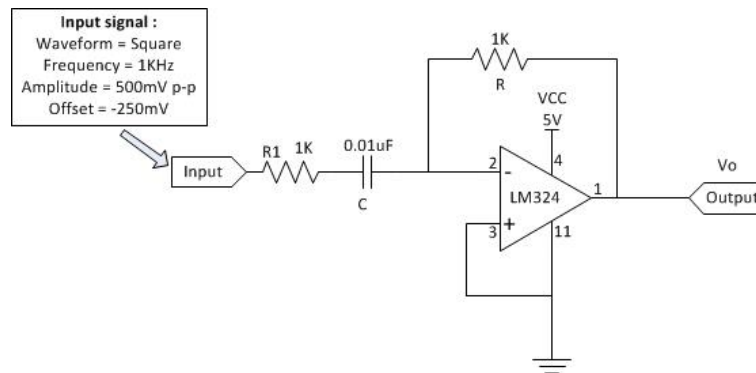

Figure 6: Differentiator.

- 2 Configure the waveform generator on the oscilloscope with following settings:
 - Waveform=Square
 - Frequency= $1KHz$
 - Amplitude= $500mV$ p-p

- Offset= $-250mV$

- 3 Connect the waveform generator output to the input of differentiator.
- 4 Connect channel 1 input (X) of the oscilloscope to the output of differentiator and connect channel 2 (Y) input of the oscilloscope to the input of differentiator.
- 5 Record the input and output waveforms displayed on the oscilloscope.