



香港中文大學  
The Chinese University of Hong Kong

CENG3420

## Lecture 01: Introduction

**Bei Yu**

(Latest update: January 9, 2019)

Spring 2019



# Overview

Course Information

Background

Organization – First Glance

Summary



# Overview

Course Information

Background

Organization – First Glance

Summary



# Course Administration

## Instructor:

- ▶ Bei Yu ([byu@cse.cuhk.edu.hk](mailto:byu@cse.cuhk.edu.hk))
- ▶ Office: SHB 907
- ▶ Office Hrs: [H13:30–15:30](#)

## Tutors:

- ▶ Haoyu Yang ([hyyang@cse.cuhk.edu.hk](mailto:hyyang@cse.cuhk.edu.hk))
- ▶ Hao Geng ([hgeng@cse.cuhk.edu.hk](mailto:hgeng@cse.cuhk.edu.hk))
- ▶ Office: SHB 905



# Grading Information

## Grade Determinates

5% Attendance

15% Homework

15% Midterm (Feb. 28)

25% Three Labs (Individual project)

40% Final Exam

- ▶ Late submission **per day** is subject to 10% of penalty.
- ▶ A student must gain at least 50% of the full marks in order to pass the course.
- ▶ A student must attend at least 80% of lectures in order to gain all class attendance credits.



# General References

## Textbook:

- ▶ *Computer Organization and Design*, 5th Edition
- ▶ Soft copy, `amazon.cn`, or `amazon.com`

## Manuals:

- ▶ LC-3 Instruction Set Architecture (ISA)
- ▶ Lab tutorials (slides)

## Slides:

- ▶ On the course web page before lecture
- ▶ Summary may be uploaded afterwards

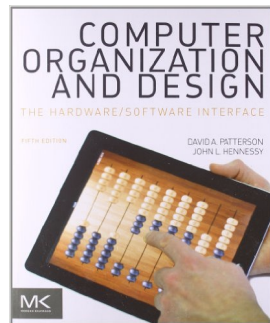

# Course Content

- ▶ Introduction to the major components of a computer system, how they function together in executing a program.
- ▶ Introduction to CPU datapath and control unit design
- ▶ Introduction to techniques to improve performance and energy-efficiency of computer systems
- ▶ Introduction to multiprocessor architecture



# Course Content

- ▶ Introduction to the major components of a computer system, how they function together in executing a program.
- ▶ Introduction to CPU datapath and control unit design
- ▶ Introduction to techniques to improve performance and energy-efficiency of computer systems
- ▶ Introduction to multiprocessor architecture

## Philosophy

To learn what determines the capabilities and performance of computer systems and to understand the interactions between the computer's architecture and its software so that **future software** designers (compiler writers, operating system designers, database programmers, application programmers, ...) can achieve the best cost-performance trade-offs and so that **future architects** understand the effects of their design choices on software.





# Why Learn This Stuff?

- ▶ You want to call yourself a “computer scientist/engineer”
- ▶ You want to build HW/SW people use (so need performance/power)
- ▶ You need to make a purchasing decision or offer “expert” advice

## **Both hardware and software affect performance/power**



- ▶ Algorithm determines number of source-level statements
- ▶ Language/compiler/architecture determine the number of machine-level instructions
- ▶ Processor/memory determine how fast and how power-hungry machine-level instructions are executed



# Kernel-memory-leaking Intel Processor Design Flaw

## Kernel-memory-leaking Intel processor design flaw forces Linux, Windows redesign

Speed hits loom, other OSes need fixes

By John Leyden and Chris Williams 2 Jan 2018 at 19:29 450  SHARE 



**Final update** A fundamental design flaw in Intel's processor chips has forced a significant redesign of the Linux and Windows kernels to defang the chip-level security bug.

Programmers are scrambling to overhaul the open-source Linux kernel's virtual memory system. Meanwhile, Microsoft is expected to publicly introduce the necessary changes to its Windows operating system in an upcoming Patch Tuesday: these changes were seeded to beta testers running fast-ring Windows Insider builds in November and December.

Crucially, these updates to both Linux and Windows will incur a performance hit on Intel products. The effects are still being benchmarked, however we're looking at a ballpark figure of five to 30 per cent slow down, depending on the task and the processor model. More recent Intel chips have features – such as PCID – to reduce the performance hit. Your mileage may vary.

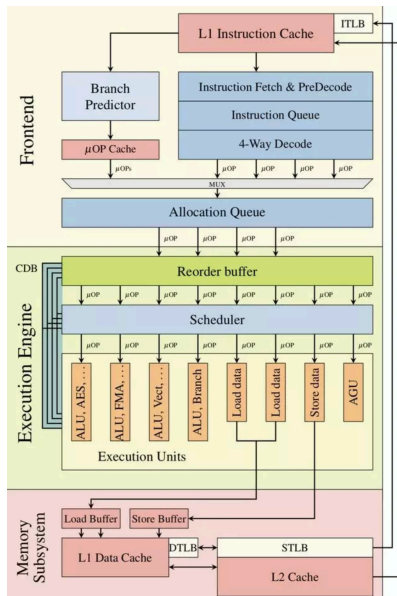

[http://www.theregister.co.uk/2018/01/02/intel\\_cpu\\_design\\_flaw/](http://www.theregister.co.uk/2018/01/02/intel_cpu_design_flaw/)



# What You Should Already Know

- ▶ Basic logic design & machine organization
  - ▶ logical minimization, FSMs, component design
  - ▶ processor, memory, I/O
- ▶ Create, run, debug programs in an assembly language
  - ▶ Will be introduced in tutorial
- ▶ Create, compile, and run C/C++ programs
- ▶ Create, organize, and edit files and run programs on Unix/Linux



# Computer Organization and Design

- ▶ This course is all about how computers work
- ▶ But what do we mean by a computer?
  - ▶ Different **types**: embedded, laptop, desktop, server
  - ▶ Different **uses**: automobiles, graphics, finance, genomics ...
  - ▶ Different **manufacturers**: Intel, Apple, IBM, Sony, Oracle ...
  - ▶ Different underlying technologies and different costs
- ▶ Analogy: Consider a course on “automotive vehicles”
  - ▶ Many similarities from vehicle to vehicle (e.g., wheels)
  - ▶ Huge differences from vehicle to vehicle (e.g., gas vs. electric)
- ▶ **Best way to learn:**
  - ▶ Focus on a specific instance and learn how it works
  - ▶ While learning general principles and historical perspectives



# Overview

Course Information

**Background**

Organization – First Glance

Summary

# The Evolution of Computer Hardware

When was the first transistor invented?

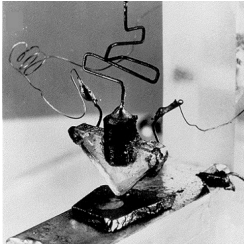

(a)



(b)

(a) 1947, bi-polar transistor, by **John Bardeen** et al. at Bell Laboratories; (b) **UNIVAC I** (Universal Automatic Computer): the first commercial computer in USA.



# The Evolution of Computer Hardware

When was the first IC (integrated circuit) invented?

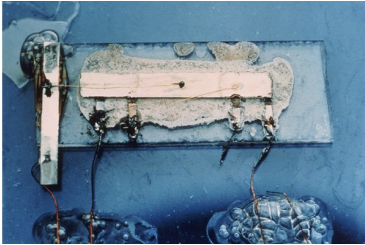

(a)



(b)

(a) 1958, by **Jack Kilby**@Texas Instruments, by hand. Several transistors, resistors and capacitors on a single substrate. (b) **IBM System/360**, 2MHz, 128KB – 256KB.



# The Evolution of Computer Hardware

When was the first Microprocessor?

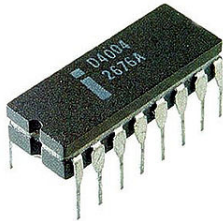

(a)

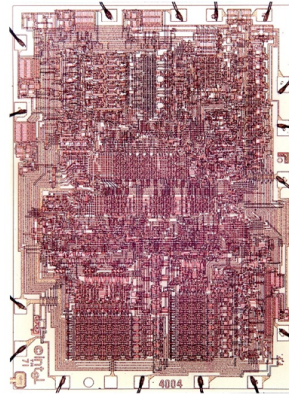

(b)

1971, Intel 4004.





# The IC Manufacturing Process

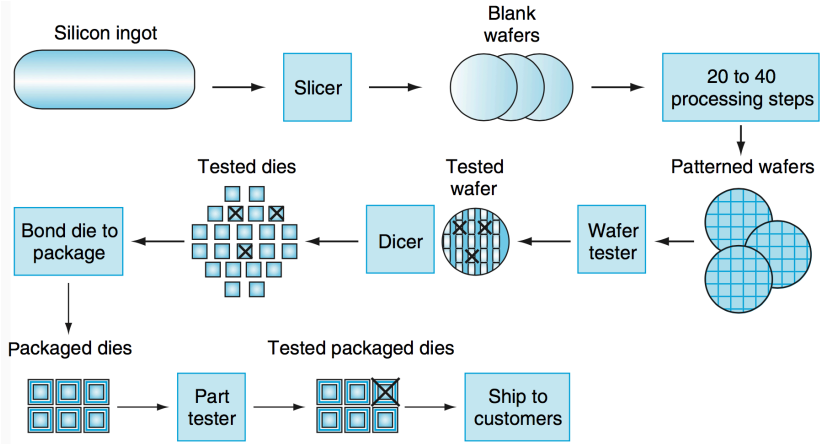

## Yield

Proportion of working dies per wafer

Check this: <https://youtu.be/d9SWNLZvA8g?list=FLELqiXCJQW-jcijW8ZAbA8w>



# AMD Opteron X2 Wafer

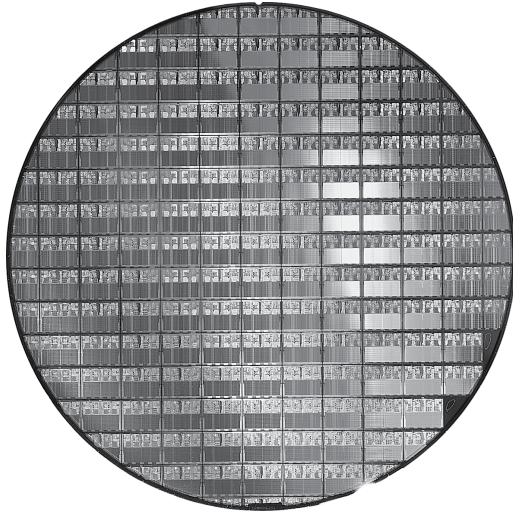

300mm wafer, 117 chips, 90nm technology.



# Integrated Circuit Cost

$$\text{Cost per die} = \frac{\text{Cost per wafer}}{\text{Dies per wafer} \cdot \text{Yield}}$$

$$\text{Dies per wafer} = \text{Wafer area} / \text{Die area}$$

$$\text{Yield} = \frac{1}{[1 + (\text{Defects per area} \cdot \text{Die area} / 2)]^2}$$

## Nonlinear relation to area and defect rate

- ▶ Wafer cost and area are fixed
- ▶ Defect rate determined by manufacturing process
- ▶ Die area determined by architecture and circuit design



# Impacts of Advancing Technology

## Processor

- ▶ Logic capacity: increases about 30% per year
- ▶ Performance:  $2\times$  every 1.5 years

## Memory

- ▶ DRAM capacity:  $4\times$  every 3 years, about 60% per year
- ▶ Memory speed:  $1.5\times$  every 10 years
- ▶ Cost per bit: decreases about 25% per year

## Disk

- ▶ Capacity: increases about 60% per year



# Moore's Law for CPUs and DRAMs

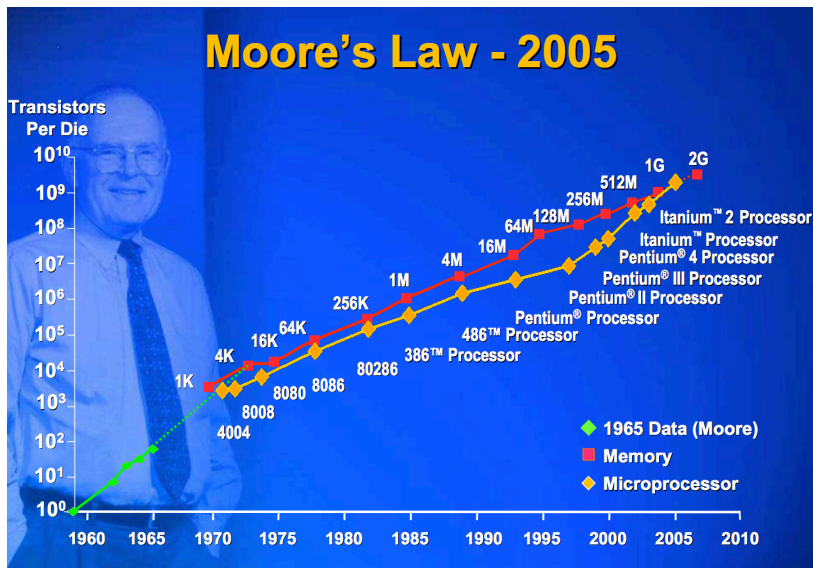

From: "Facing the Hot Chips Challenge Again", Bill Holt, Intel, presented at Hot Chips 17, 2005.



# Main driver: device scaling ...

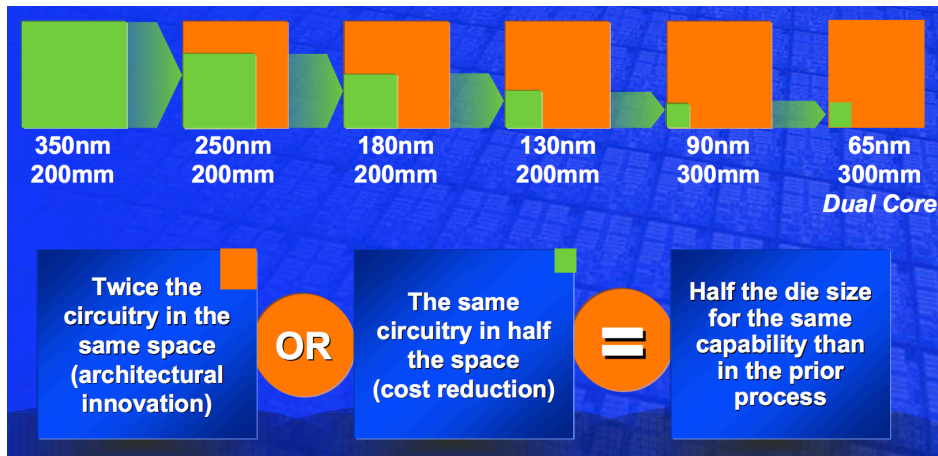

From: "Facing the Hot Chips Challenge Again", Bill Holt, Intel, presented at Hot Chips 17, 2005.



# Technology Scaling Road Map (ITRS)

Year	2004	2006	2008	2010	2012
Feature size (nm)	90	65	45	32	22
Intg. Capacity (BT)	2	4	6	16	32

## Fun facts about 45nm transistors

- ▶ 30 million can fit on the head of a pin
- ▶ You could fit more than 2,000 across the width of a human hair
- ▶ If car prices had fallen at the same rate as the price of a single transistor since 1968, a new car today would cost about 1 cent



# Highest Clock Rate of Intel Processors

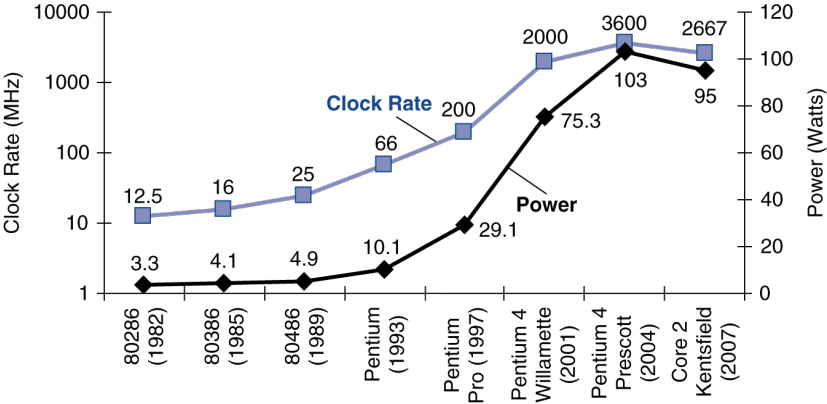



# Highest Clock Rate of Intel Processors

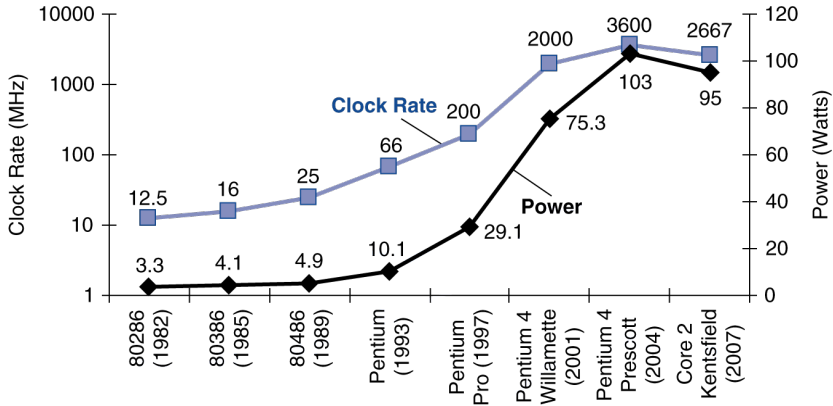

What if the exponential increase had kept up? Why not?

- ▶ Due to process improvements
- ▶ Deeper pipeline
- ▶ Circuit design techniques



# Power Issue

$$\text{Power} = \text{Capacitive load} \cdot \text{Voltage}^2 \cdot \text{Frequency}^*$$

## Example

For a simple processor, if capacitive load is reduced by 15%, voltage is reduced by 15%, maintain the same frequency, how much power consumption can be reduced?

---

\*here we only consider dynamic power, but not static power



# A Sea Change Is at Hand

- ▶ The power challenge has forced a change in the design of microprocessors
- ▶ Since 2002 the rate of improvement in the response time of programs on desktop computers has slowed from a factor of 1.5 per year to less than a factor of 1.2 per year
- ▶ As of 2006 all desktop and server companies are shipping microprocessors with multiple processors – cores – per chip
- ▶ Plan of record is to **add two cores** per chip per generation (about every two years)

Product	AMD Barcelona	Intel Nehalem	IBM Power 6	Sun Niagara 2
Cores per chip	4	4	2	8
Clock rate	~2.5 GHz	~2.5 GHz	4.7 GHz	1.4 GHz
Power	120 W	~100 W	~100 W	94 W



# Intel Core i7 Processor

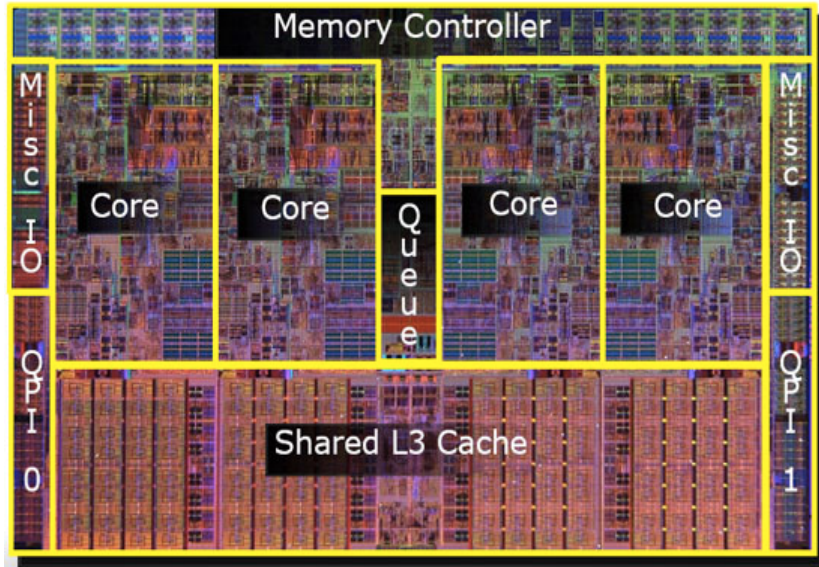

45nm technology, 18.9mm x 13.6mm, 0.73billion transistors, 2008



# A Computer



*apple*

## Desktop computers

Designed to deliver good performance to a single user at low cost usually executing 3rd party software, usually incorporating a graphics display, a keyboard, and a mouse



# Other Classes of Computers

## Servers

Used to run larger programs for multiple, simultaneous users typically accessed only via a network and that places a greater emphasis on dependability and (often) security

## Supercomputers

A high performance, high cost class of servers with hundreds to thousands of processors, terabytes of memory and petabytes of storage that are used for high-end scientific and engineering applications.

## Embedded computers (processors)

A computer inside another device used for running one predetermined application



# Supercomputers

## Tianhe-2 (MilkyWay-2)

- ▶ Over 3 million cores
- ▶ Power: 17.6 MW (24 MW with cooling)
- ▶ Speed: 33.86 PFLOPS (peta =  $10^{15}$ )

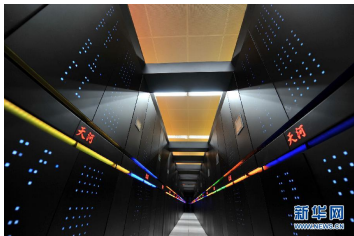

# Embedded Computers in You Car

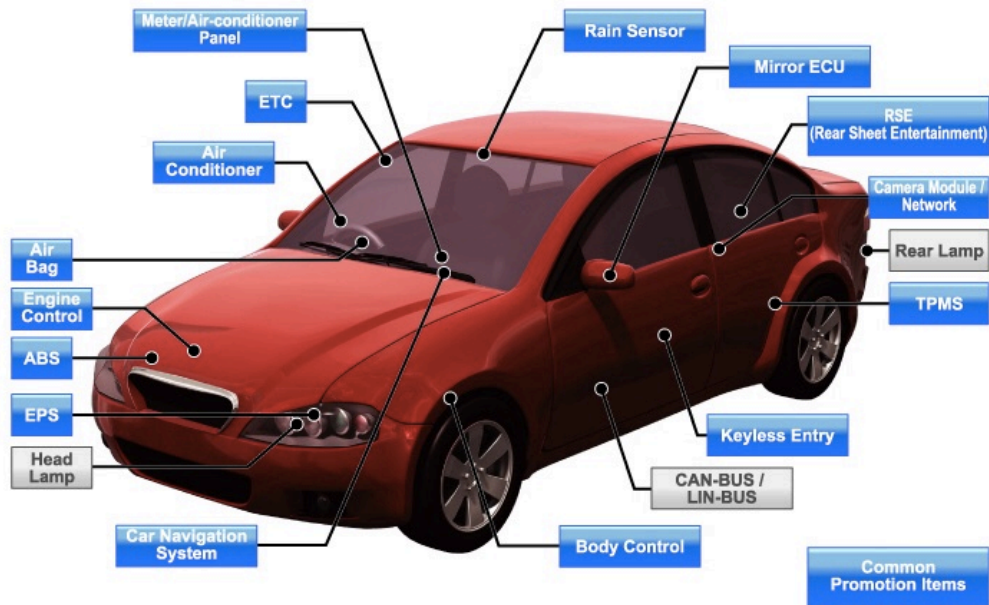



# PostPC Era

## Personal Mobile Device (PMD)

Battery-operated device with wireless connectivity

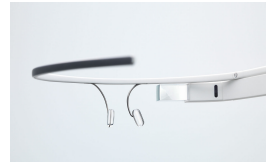

## Warehouse Scale Computer (WSC)

Datacenter containing hundreds of thousands of servers providing software as a service  
(SaaS)

# Growth in Cell Phone Sales (Embedded)

- ▶ embedded growth >> desktop growth
- ▶ Where else are embedded processors found?

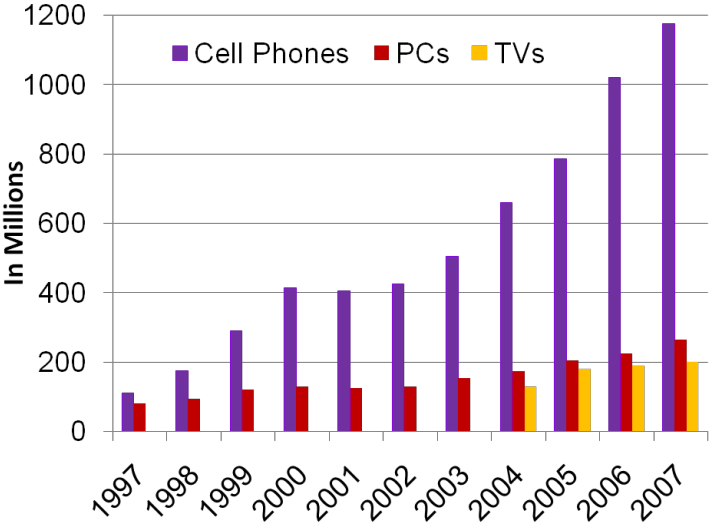

# When Machine Learning Meets Hardware

Convolution layer is one of the most expensive layers

- ▶ Computation pattern
- ▶ Emerging challenges

More and more end-point devices with limited memory

- ▶ Cameras
- ▶ Smartphone
- ▶ Autonomous driving

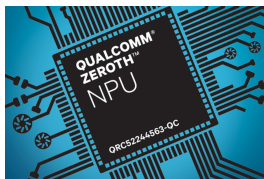
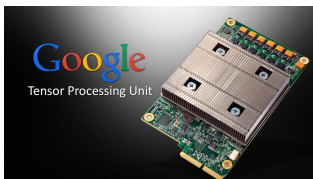

# Convolutional Neural Network (CNN)

## Autonomous drive

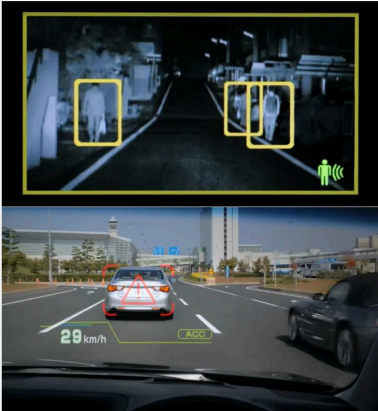

## Image recognition

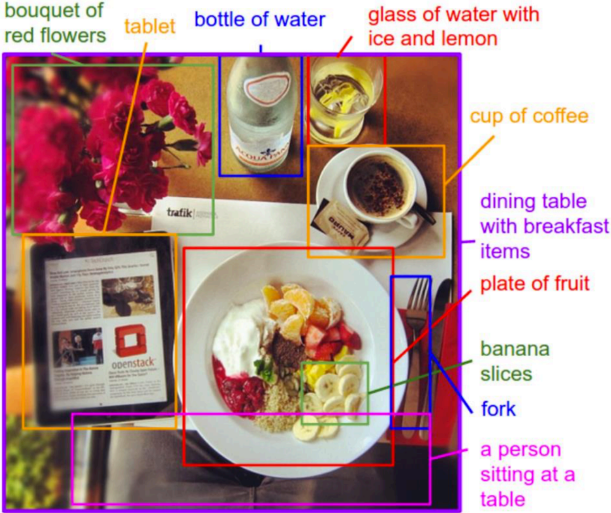

# Bottleneck of CNN

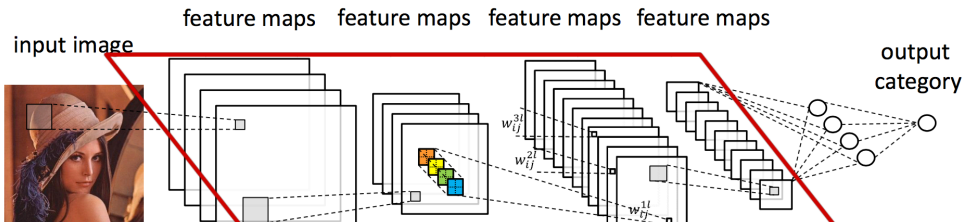

**Convolutional layers account for over 90% computation**

[1] A. Krizhevsky, etc. Imagenet classification with deep convolutional neural networks. NIPS 2012.

[2] J. Cong and B. Xiao. Minimizing computation in convolutional neural networks. ICANN 2014

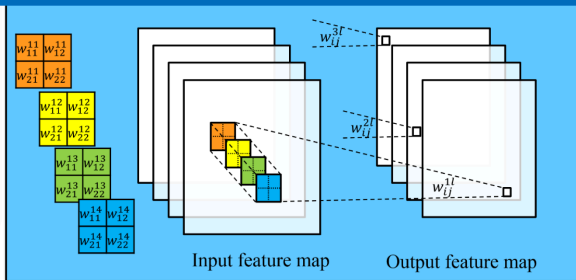

**Max-pooling is optional**

Input feature map

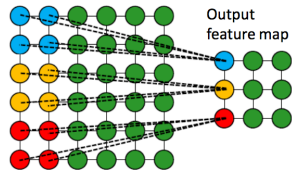

# In-Datcenter Performance Analysis of a Tensor Processing Unit™

Norman P. Jouppi, Cliff Young, Nishant Patil, David Patterson, Gaurav Agrawal, Raminder Bajwa, Sarah Bates, Suresh Bhatia, Nan Boden, Al Borchers, Rick Boyle, Pierre-luc Cantin, Clifford Chao, Chris Clark, Jeremy Coriell, Mike Daley, Matt Dau, Jeffrey Dean, Ben Gelb, Tara Vazir Ghaemmaghami, Rajendra Gottipati, William Gulland, Robert Hagmann, C. Richard Ho, Doug Hogberg, John Hu, Robert Hundt, Dan Hurt, Julian Ibarz, Aaron Jaffey, Alek Jaworski, Alexander Kaplan, Harshit Khaitan, Daniel Killebrew, Andy Koch, Naveen Kumar, Steve Lacy, James Laudon, James Law, Diemthu Le, Chris Leary, Zhuyuan Liu, Kyle Lucke, Alan Lundin, Gordon MacKean, Adriana Maggiore, Maire Mahony, Kieran Miller, Rahul Nagarajan, Ravi Narayanaswami, Ray Ni, Kathy Nix, Thomas Norrie, Mark Omernick, Narayana Penukonda, Andy Phelps, Jonathan Ross, Matt Ross, Amir Salek, Emad Samadiani, Chris Severn, Gregory Sizikov, Matthew Snelham, Jed Souter, Dan Steinberg, Andy Swing, Mercedes Tan, Gregory Thorson, Bo Tian, Horia Toma, Erick Tuttle, Vijay Vasudevan, Richard Walter, Walter Wang, Eric Wilcox, and Doe Hyun Yoon

Google, Inc., Mountain View, CA USA

Email: {jouppi, cliffy, nishantpatil, davidpatterson}@google.com

To appear at the 44th International Symposium on Computer Architecture (ISCA), Toronto, Canada, June 26, 2017.

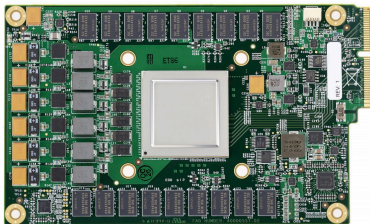

**Figure 3.** TPU Printed Circuit Board. It can be inserted in the slot for an SATA disk in a server, but the card uses PCIe Gen3 x16.

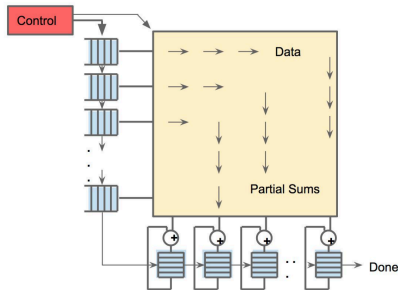

**Figure 4.** Systolic data flow of the Matrix Multiply Unit. Software has the illusion that each 256B input is read at once, and they instantly update one location of each of 256 accumulator RAMs.



# Overview

Course Information

Background

Organization – First Glance

Summary



# What is a Computer?

## Components

- ▶ processor (datapath, control)
- ▶ input (mouse, keyboard)
- ▶ output (display, printer)
- ▶ memory (cache, main memory, disk drive, CD/DVD)
- ▶ network

**Our primary focus: the processor (datapath and control) and its interaction with memory systems**

- ▶ Implemented using tens/hundreds of millions of transistors
- ▶ Impossible to understand by looking at each transistor
- ▶ We need abstraction!





# Major Components of a Computer

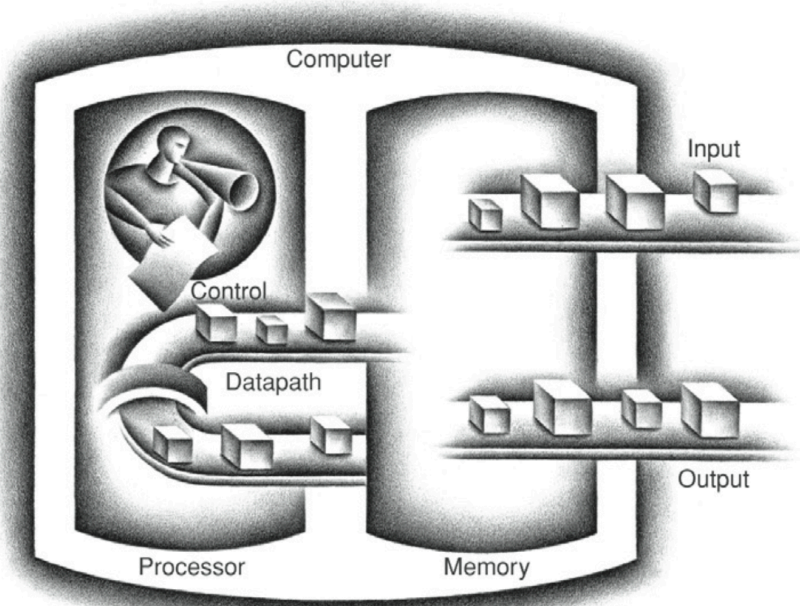

# Machine Organization

- ▶ Capabilities and performance characteristics of the principal Functional Units (FUs). (e.g., register file, ALU, multiplexers, memories, ...)
- ▶ The ways those FUs are interconnected (e.g., buses)
- ▶ Logic and means by which information flow between FUs is controlled
- ▶ The machine's Instruction Set Architecture (ISA)
- ▶ Register Transfer Level (RTL) machine description

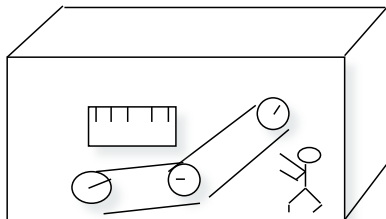

# Processor Organization

## Control needs to have **circuitry** to

- ▶ Decide which is the next instruction and input it from memory
- ▶ Decode the instruction
- ▶ Issue signals that control the way information flows between datapath components
- ▶ Control what operations the datapath's functional units perform

## Datapath needs to have **circuitry** to

- ▶ Execute instructions - functional units (e.g., adder) and storage locations (e.g., register file)
- ▶ Interconnect the functional units so that the instructions can be executed as required
- ▶ Load data from and store data to memory



# System Software

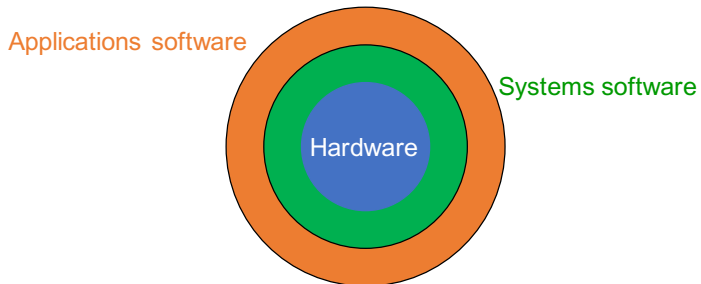

## Operating System

- ▶ Supervising program that interfaces the user's program with the hardware (e.g., Linux, iOS, Windows)
- ▶ Handles basic input and output operations
- ▶ Allocates storage and memory
- ▶ Provides for protected sharing among multiple applications

## Compiler

- ▶ Translate programs written in a high-level language (e.g., C, Java) into instructions that the hardware can execute



# Advantages of Higher-Level Languages ?

- ▶ Allow the programmer to think in a **more natural language** and for their intended use (Fortran for scientific computation, Cobol for business programming, Lisp for symbol manipulation, Java for web programming, ...)
- ▶ Improve programmer **productivity** – more understandable code that is easier to debug and validate
- ▶ Improve program **maintainability**
- ▶ Allow programs to be **independent** of the computer on which they are developed (compilers and assemblers can translate high-level language programs to the binary instructions of any machine)
- ▶ Emergence of optimizing compilers that produce very efficient assembly code optimized for the target machine

As a result, very little programming is done today at the assembler level



# Below the Program

- High-level language program (in C)

```
swap (int v[], int k)
(int temp;
    temp = v[k];
    v[k] = v[k+1];
    v[k+1] = temp;
)
```

- Assembly language program (for MIPS)

```
swap:  sll    $2, $5, 2
        add   $2, $4, $2
        lw    $15, 0($2)
        lw    $16, 4($2)
        sw    $16, 0($2)
        sw    $15, 4($2)
        jr    $31
```

- Machine (object) code (for MIPS)

```
000000 00000 00101 0001000010000000
000000 00100 00010 0001000000010000
. . .
```

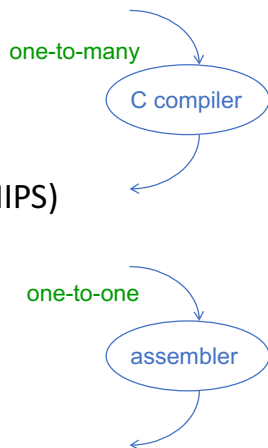

# Below the Program

- High-level language program (in C)

```
swap (int v[], int k)
(int temp;
    temp = v[k];
    v[k] = v[k+1];
    v[k+1] = temp;
)
```

one-to-many

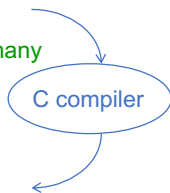

- Assembly language program (for MIPS)

```
swap:  sll    $2, $5, 2
       add    $2, $4, $2
       lw     $15, 0($2)
       lw     $16, 4($2)
       sw     $16, 0($2)
       sw     $15, 4($2)
       jr     $31
```

one-to-one

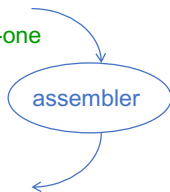

- Machine (object) code (for MIPS)

```
00000000 000000 00101 0001000010000000
00000000 001000 00010 000100000001000000
. . . .
```

**Max # of operations?**



# Input Device Inputs Object Code

```
000000 00000 00101 0001000010000000
000000 00100 00010 0001000000100000
100011 00010 01111 0000000000000000
100011 00010 10000 0000000000000100
101011 00010 10000 0000000000000000
101011 00010 01111 0000000000000100
000000 11111 00000 0000000000001000
```

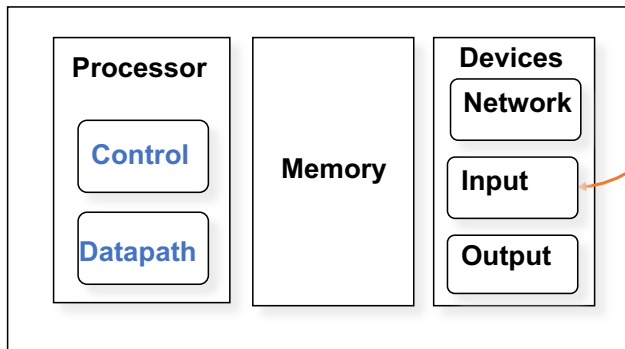



# Object Code Stored in Memory

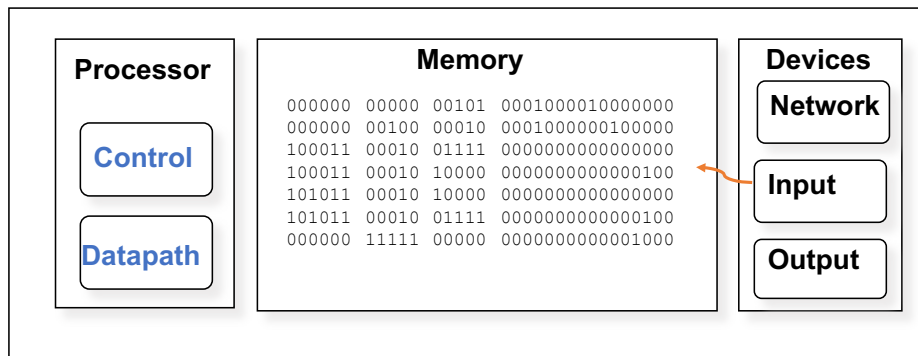

# Object Code Stored in Memory

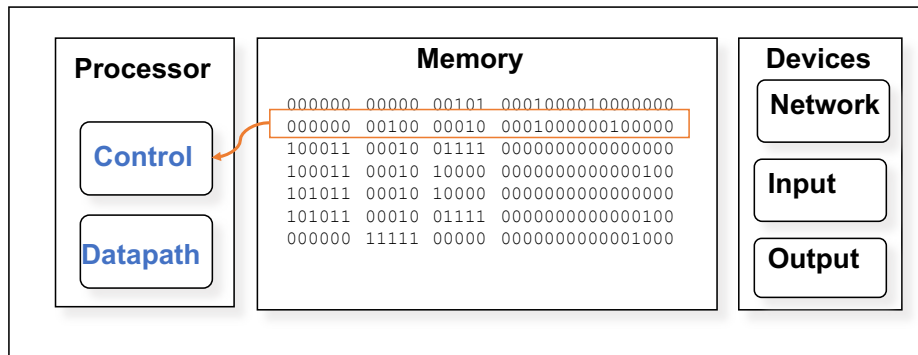

Processor **fetches** an instruction from memory

# Decode & Execute Codes

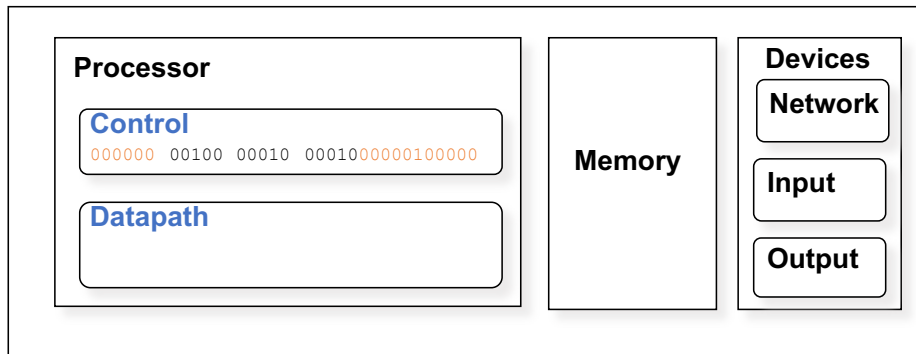

- ▶ Control **decodes** the instruction to determine what to execute

# Decode & Excute Codes

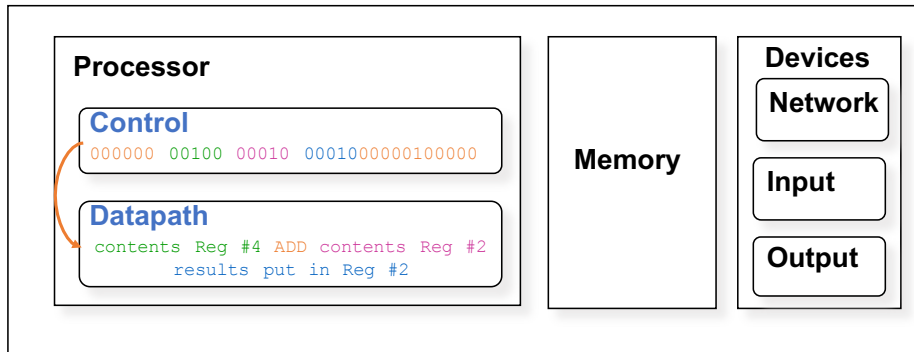

- ▶ Control **decodes** the instruction to determine what to execute
- ▶ Datapath **executes** the instruction as directed by control

# What Happens Next?

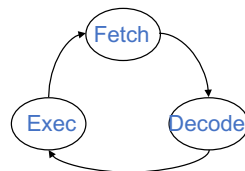
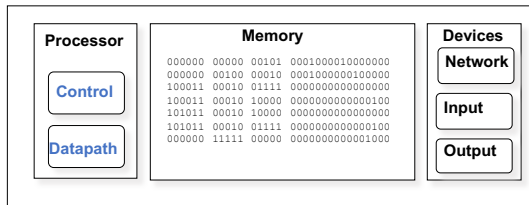

- ▶ Processor fetches the next instruction from memory
- ▶ How does it know which **location** in memory to fetch from next?



# Output Device Outputs Data

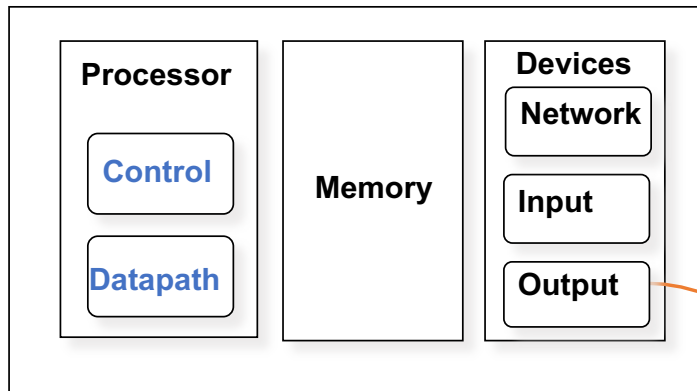

```
000010001010000000000000000000  
000000001001111000000000000100  
000001111100000000000000000100
```



## Instruction Set Architecture (ISA)

The interface description separating the software and hardware

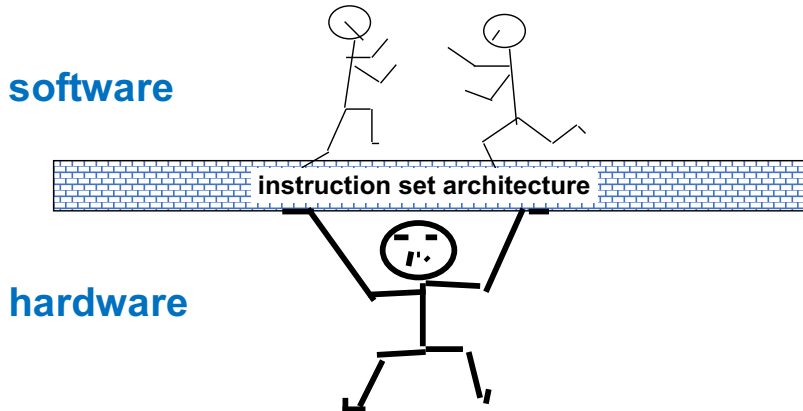

# Instruction Set Architecture (ISA)

- ▶ ISA, or simply architecture – the abstract interface between the hardware and the lowest level software that includes all the information necessary to write a machine language program, including instructions, registers, memory access, I/O, ...
- ▶ Enables **implementations** of varying cost and performance to run identical software
- ▶ The combination of the basic instruction set (the ISA) and the operating system interface is called the application binary interface (**ABI**)
- ▶ ABI: The user portion of the instruction set plus the operating system interfaces used by application programmers. Defines a standard for binary portability across computers.





# The MIPS ISA

## Instruction Categories

- ▶ Load/Store
- ▶ Computational
- ▶ Jump and Branch
- ▶ Floating Point
- ▶ Memory Management
- ▶ Special

## Registers

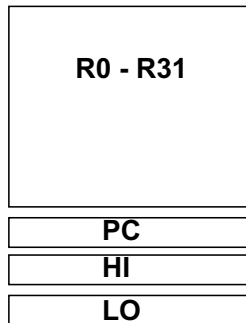

## 3 Instruction Formats: all 32 bits wide

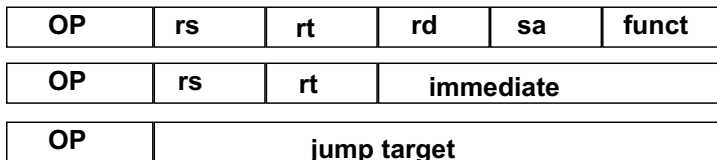

# Overview

Course Information

Background

Organization – First Glance

Summary



# How Do the Pieces Fit Together?

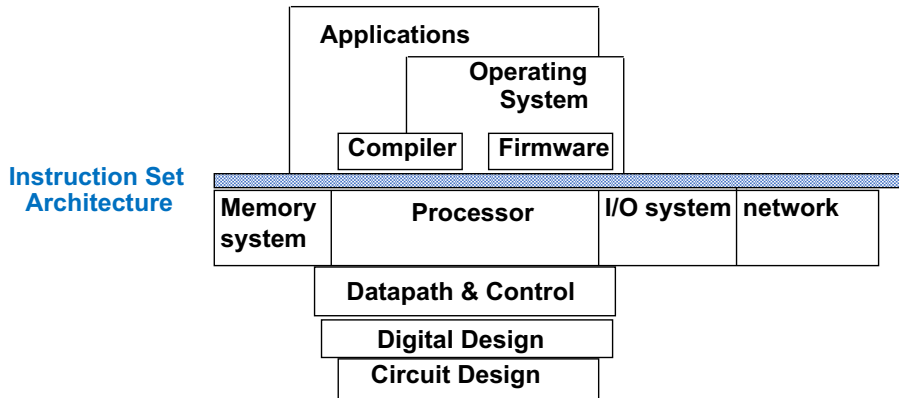

- ▶ Coordination of many **levels of abstraction**
- ▶ Under a **rapidly changing** set of forces
- ▶ Design, measurement, **and** evaluation



# How Do the Pieces Fit Together?

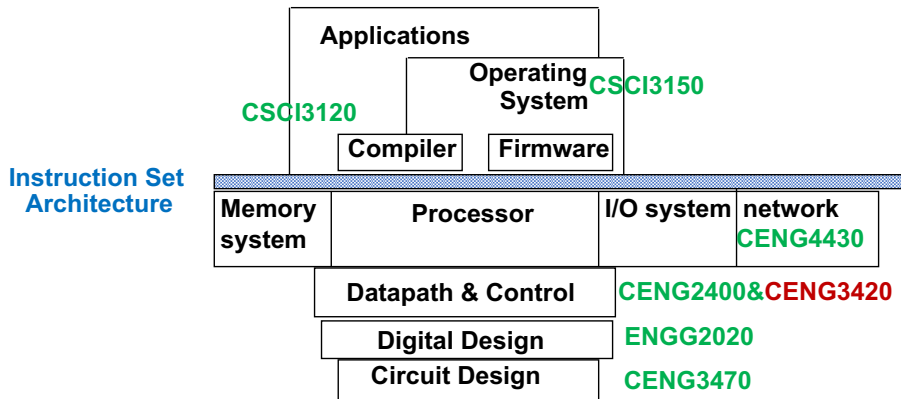

- ▶ Coordination of many **levels of abstraction**
- ▶ Under a **rapidly changing** set of forces
- ▶ Design, measurement, **and** evaluation

