

Department of Computer Science and Engineering
計算機科學與工程學系

Computer Science and Engineering (JS4412 / BCSEN)

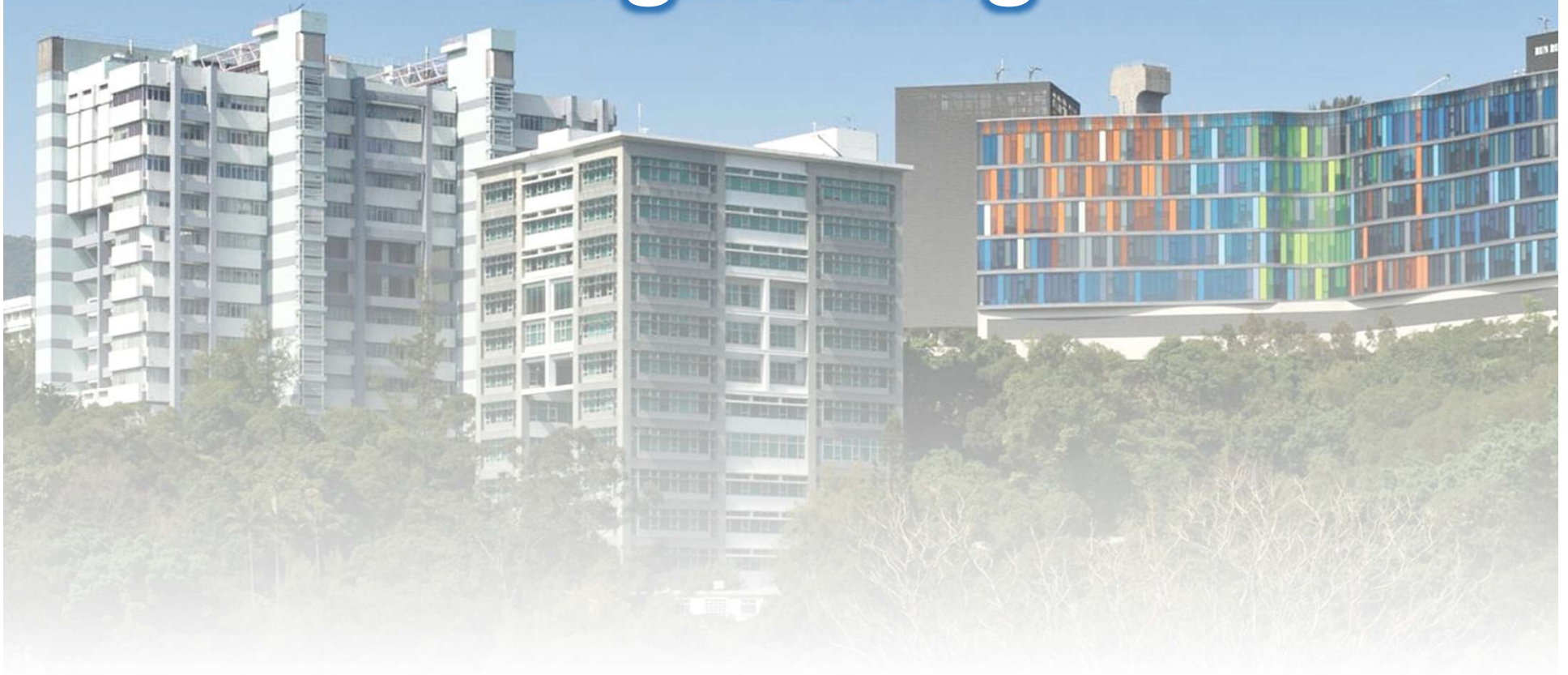

Department of Computer Science and Engineering



Let's take a look at our department



Department of Computer Science and Engineering

<https://www.youtube.com/watch?v=yREmhlIWI80>

A Long History

- The first computer science department in HK
- Offering **AIST**, **CDAS**, **CENG** and **CSCI** programmes
- A strong alumni network

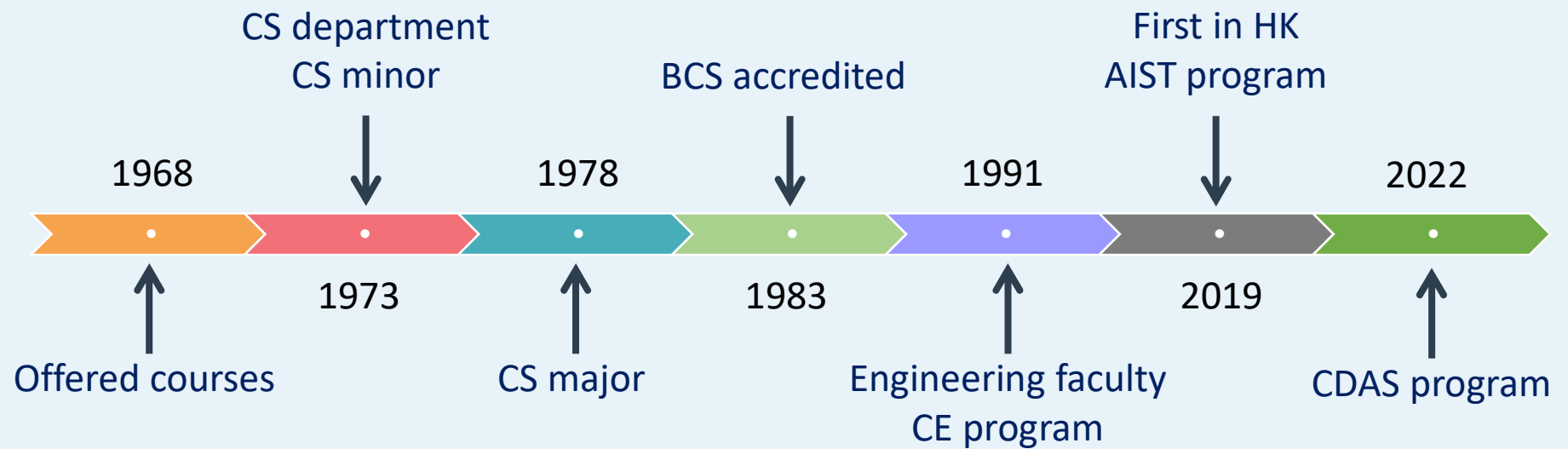

Excellence in Teaching and Research



2021 Kyoto Prize Laureate and Turing Award Recipient

Prof. Andrew Yao

Seven ACM Fellows

Prof. Andrew Yao, Prof. Martin Wong, Prof. Michael Lyu, Prof. Benjamin W. Wah, Prof. John Lui, Prof. Yufei Tao, etc.

Ten IEEE Fellows

Prof. Irwin King, Prof. John Lui, Prof. Jiaya Jia, etc.

2021 INNS Dennis Gabor Award

Prof. Irwin King

Forbes 30 Under 30 Asia (Healthcare & Science Category) – Class of 2022

Prof. Yu Li

Hong Kong Academy of Engineering Sciences Fellows 2021

Prof. Michael Lyu

InnoStars Award 2021

Prof. Jiaya Jia

Vice-Chancellor's Exemplary Teaching Award 2021

Prof. Yufei Tao

Recent Achievements in Intl'/local Competitions

Robocon Hong Kong Contest 2022

Championship

3 Awards in International Conference on Computer-Aided Design (ICCAD)

1st place for topic "GPU-Accelerated Logic Rewriting" and 2nd place for "Routing with Cell Movement Advanced" in 2021 CAD Contest

- **2nd place in 2021 CADathlon**

International Collegiate Programming Contest (ICPC) (formerly named ACM Programming Competition)

2019: ranked 12th (over 3000 universities)

2012: ranked 8th

2011: ranked 13th

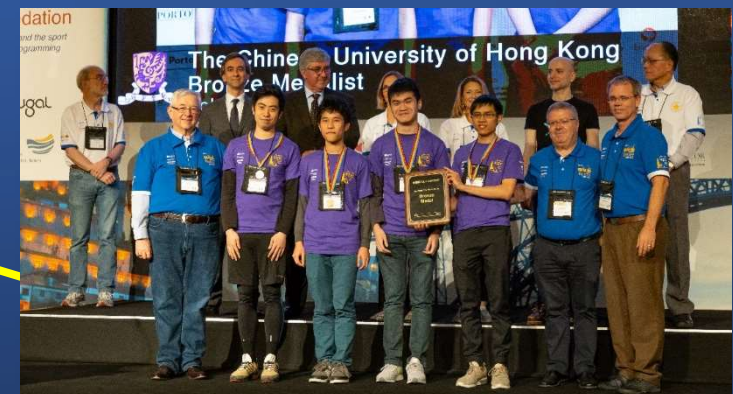

2001: ranked 8th



2022 QS World University Ranking

- **#26 Worldwide in Computer Science and Information Systems**
- **#5 in Asia**
- **#1 in Hong Kong**

(<https://www.topuniversities.com/university-rankings/university-subject-rankings/2022/computer-science-information-systems>)

↑ Rank	↓ University	↓ Overall Score
26	 The Chinese University of Hong Kong... 📍 Hong Kong SAR, Hong Kong SAR	78
=29	 The Hong Kong University of Science... 📍 Hong Kong SAR, Hong Kong SAR	77.3
=39	 The University of Hong Kong 📍 Hong Kong SAR	75.2

CSRanking in 2022

- **#33 worldwide in Computer Science**
- **#9 in Asia**
- **#1 in Hong Kong**

(<http://csranks.org/#/fromyear/2021/toyear/2022/index?all&world>)

CSRankings: Computer Science Rankings

CSRankings is a metrics-based ranking of top computer science institutions around the world. **Click on a triangle** (▶) to expand areas or institutions. **Click on a name** to go to a faculty member's home page. **Click on a chart icon** (the  after a name or institution) to see the distribution of their publication areas as a . **Click on a Google Scholar icon** () to see publications, and **click on the DBLP logo** () to go to a DBLP entry. *Applying to grad school? Read this first.* **Do you find CSrankings useful? Sponsor CSrankings on GitHub.**

Rank institutions in by publications from to

All Areas off | on

AI off | on

- ▶ Artificial intelligence
- ▶ Computer vision
- ▶ Machine learning & data mining
- ▶ Natural language processing
- ▶ The Web & information retrieval

Systems off | on

- ▶ Computer architecture
- ▶ Computer networks
- ▶ Computer security
- ▶ Databases

23	▶ University of Texas at Austin  	1.8	33
23	▶ University of Wisconsin - Madison  	1.8	41
33	▶ Chinese University of Hong Kong  	1.7	31
33	▶ HKUST  	1.7	28
33	▶ Nanyang Technological University  	1.7	42
33	▶ Princeton University  	1.7	27
33	▶ Univ. of California - Irvine  	1.7	34
33	▶ Univ. of California - Los Angeles  	1.7	28
33	▶ University of Massachusetts Amherst  	1.7	36
33	▶ University of Pennsylvania  	1.7	42

Student Training

CUHK Amazon Deep Learning Workshop 2019 & AWSome Day 2020

Cooperated with Amazon to offer student training in deep neural networks and machine learning



City Challenge – Bridge to a Smarter City 2016

Designed technology-based living applications for the elderly and won the second runner-up

Industrial Visits

- Visit to companies to learn latest development in industry



Work-Study Scheme

- One-year placement and internship for students to gain practical experience in a real working environment

More details will be announced when places are available!

Example of Previous Opportunities in CSE

Google

Microsoft



HSBC

恒生銀行 HANG SENG BANK

新鴻基地產
Sun Hung Kai Properties

ASM Pacific Technology

HKSTP
香港科技園



FUJITSU

Strong Alumni Network

IT Industry



Education

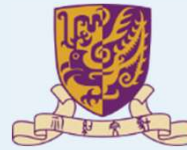

Banking

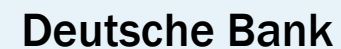

Graduate Employment Statistics in 2021

Employment Status (CE)

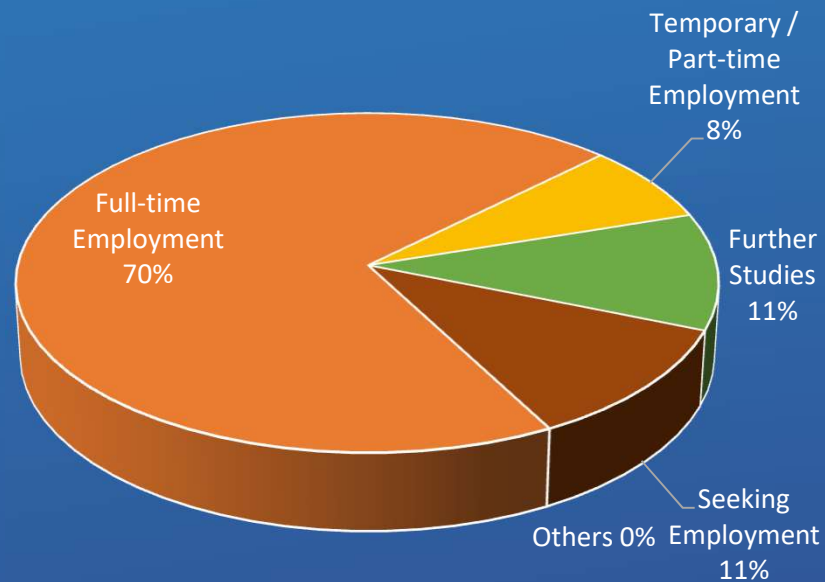

Employment Status (CS)

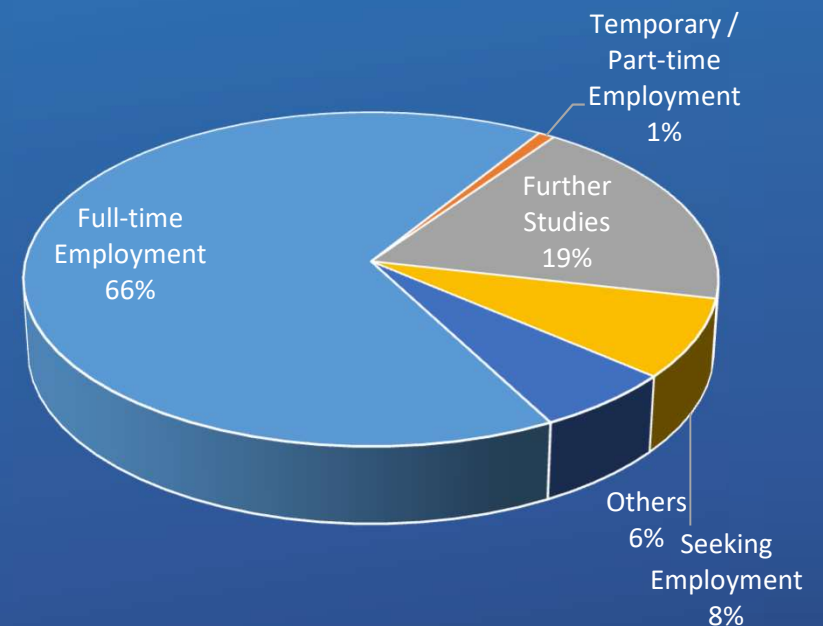

Monthly Salary of CE & CS Graduates

Programme	Median (HK\$)	Mean (HK\$)	Minimum (HK\$)	Maximum (HK\$)
Computer Engineering	18,000	21,031	10,000	65,833
Computer Science	19,500	21,300	14,000	44,000

Graduate Employment Statistics in 2021

Sectors of Employing Organisations of Graduates

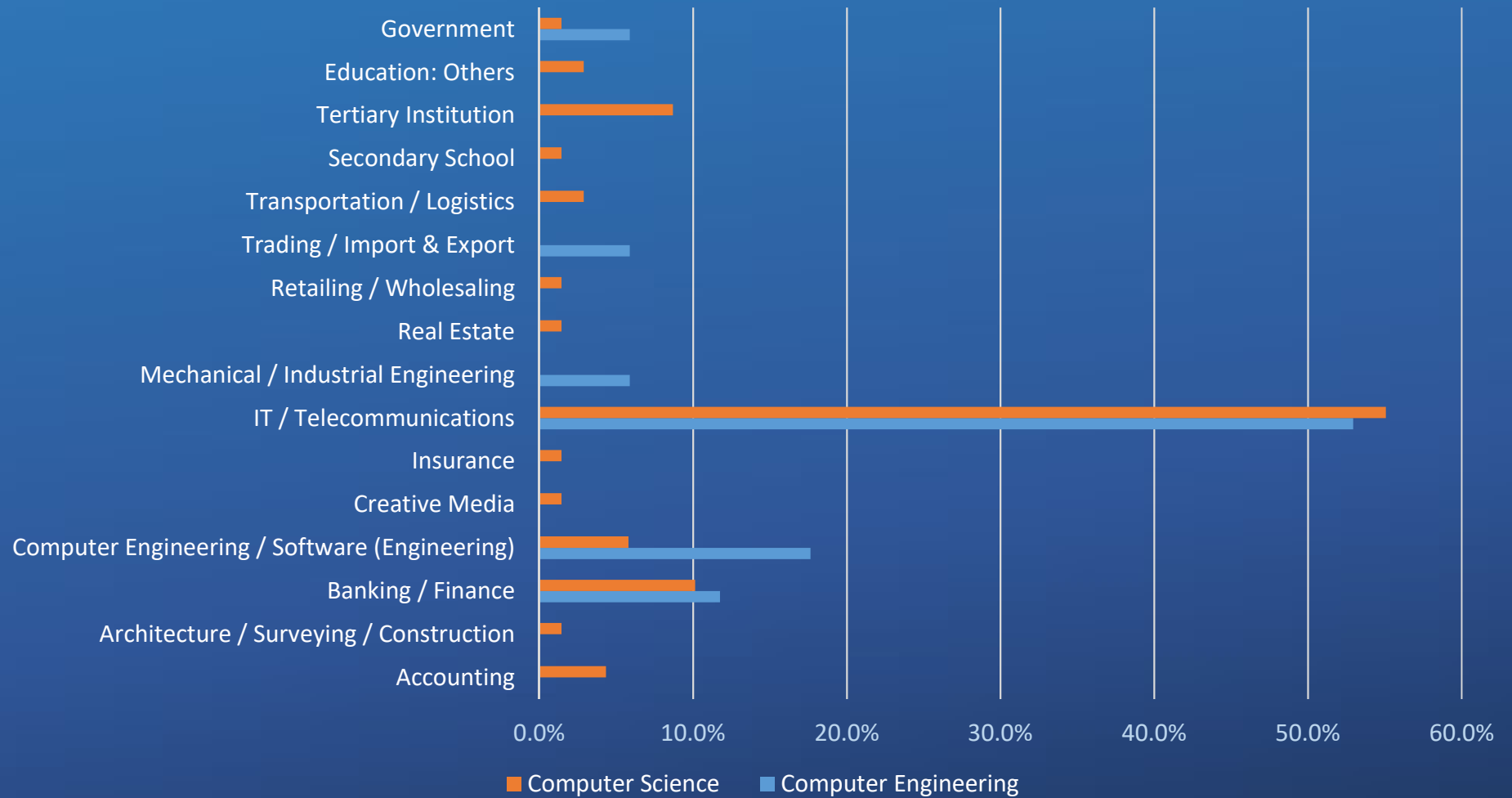

Sharing from Our CSE Students

I'm now working in Deloitte's Cyber Risk Advisory Team. Cybersecurity is a promising job, you can equip yourself to be a cybersecurity expert by enrolling relevant courses provided by the Department of Computer Science and Engineering. Cybersecurity professionals, like information security analysts, protect businesses, governments, and individuals from criminal activities on the internet. With the explosive growth of the internet in business, education, and personal communication, computer experts with knowledge of cybersecurity are in high demand.



Ka Ki CHAU,
CSCI Graduate of 2021

Sharing from Our CSE Students

The courses offered by the CSE department give a solid foundation on both the practical and theoretical sides of CSCI programme. I'm now working in Google's Android Pixel team, topics from CSCI courses still often pop up during my day-to-day job. As the software industry becomes increasingly competitive, I feel quite lucky that I've undergone such rigorous academic training.



Yu CHAO,
CSCI Graduate of 2020

Sharing from Our CSE Students



Hei Yiu LAW,
CENG Graduate of 2021

During the 4 years of my study as a CENG student, I could take courses on different topics. These courses not only consolidate my knowledge related to my major but can also train up my critical thinking and logical thinking skills. We have to design and implement a smart hardware product in just a few weeks and this project not only gives me a hands-on experience on designing smart hardware product, but also improves my communication skill and time management skill.

Growing Demand and Opportunities

- Skills in **computer software**, **industrial automation**, machine learning, network and security, **robotics**, *etc.* are of keen demand in many emerging jobs (LinkedIn 2020 Emerging Jobs Report)

Engineering isn't a new profession by any means, but engineering roles across the board are still seeing tremendous growth. More than 50% of this year's list was made up of roles related to engineering or development, with the emerging field of robotics appearing for the first time.

- **150M technology-related jobs expected to be added globally over the next five years** (LinkedIn Jobs on the Rise in 2021)

Digital Transformation

Digital platforms are more important than ever to our everyday lives. The primary ways we communicate and consume information now happen in front of screens. The demand for digital skills is increasing, with no signs of slowing down.

150M

Number of technology-related jobs expected to be added globally over the next five years



Reference:

https://business.linkedin.com/content/dam/me/business/en-us/talent-solutions/emerging-jobs-report/Emerging_Jobs_Report_US_FINAL.pdf

<https://business.linkedin.com/talent-solutions/resources/talent-acquisition/jobs-on-the-rise-us#digital>

Growing Demand and Opportunities

- Hong Kong's start-up ecosystem is **thriving**. In 2021, the number of start-ups in Hong Kong **grew by 12%** to 3,755, **employing over 13,000 people**.
 - » Hong Kong is a **strategic business platform & marketplace in Asia**
- The Global Innovation Index that evaluated 132 economies ranked Hong Kong at **14th (Year 2021)**
 - » The demand for the job in tech sectors has been **growing rapidly** over the years.

Industry Data

Global Rankings	2018	2019	2020	2021
Global Innovation Index	14/126	13/129	11/131	14/132
IMD Digital Competitiveness	11/63	8/63	5/63	2/64

Source: Global Innovation Index Reports; IMD World Competitiveness Centre

Reference:

<https://research.hktdc.com/en/article/MzEzOTlwMDIy>

What's More?

- Chances to **create your own project and innovation** with support and advice from CSE teachers
- **Exchange opportunities** to world-class universities
- **High competitiveness** in job market with **90%** of CSE graduates employed within one month of graduation
- CSE teachers usually have the **highest teaching evaluation scores**

Why CSE Department?



Office 秀
X W P
PS
Google G-Suite
暑期課程
CS Society
知有疑問請聯絡
67689694 (Wings)
COURSE 1
GOOGLE SUITE & MICROSOFT OFFICE
17 · 18 · 24 · 25
JUN
@SUB924
COURSE 2
PHOTOSHOP & 美國券券
16:30-18:15
想相片更有特色?
更好看?
想弄個天使臉孔魔鬼身材的女神頭像?
\$480/2
報名表格

Because it is fun!



Admission Arrangement and Requirements (First Year Entry)



Admission Arrangement (First Year Entry)

- Students will be admitted into **Computer Science and Engineering (JS4412)**
- They will then be allocated into one of the majors in the Major Allocation exercise after Year 1
 - » **Computer Engineering (CENG)**
 - » **Computer Science (CSCI)**

Major Allocation:

<https://www.cse.cuhk.edu.hk/admission/cengn/major-allocation-cengn/>

<https://www.cse.cuhk.edu.hk/admission/cscin/major-allocation-cscin/>

Admission Requirements (For JUPAS Applicants)

HKDSE Subject	Minimum Level	Subject Weighting
HKDSE Core Subjects		
English Language	3	1
Chinese Language	3	1
Mathematics (Compulsory Part)	4	1.5
Liberal Studies	2	0.5
HKDSE Elective Subjects		
One specific science subject [^]	3	1.5 – 1.75
Any one other subject [#]	3	1 – 1.75

[^] *Specific science subjects and subject weighting include 1.75 for Maths M1/M2, 1.5 for Biology, Chemistry, Physics and Combined Science.*

[#] *Preferred subjects include 1.75 for Maths M1/M2, 1.5 for Biology, Chemistry, Physics, Combined Science, Design and Applied Technology and Information and Communication Technology, and 1 for other subjects. Please refer to <https://www.cse.cuhk.edu.hk/> for details of subject weighting.*

Selection is based on the Best 5 HKDSE subjects with subject weighting applied. Bonus points will be awarded to the 6th and 7th subjects, if any.

Admission Requirements (for Non-JUPAS & International Applicants)

- Applicants seeking admission on the strength of qualifications other than HKDSE examination results (e.g., **IB, GCE-AL, overseas qualifications**) can apply through **Non-JUPAS channels**
- Will be considered on the basis of their **education background** and **academic achievements**
- Can apply for **“Admission with Advanced Standing”** (for particular qualifications only)

Check more details at OAFA’s website!

Non-JUPAS Applications: <http://admission.cuhk.edu.hk/non-jupas-yr-1/requirements.html>

International Applications: <http://admission.cuhk.edu.hk/international/requirements.html>

Admission Arrangement and Requirements (Senior Year Entry)



Admission Arrangement (Senior Year Entry)

- Applicable for **local applicants with Associate Degree or Higher Diploma qualifications** only
- To meet the entrance requirements, you need to have,
 - » successfully completed a local course of study leading to the **qualification of associate degree / higher diploma, preferably with overall CGPA ≥ 3.0 or equivalent, AND**
 - » Met the minimum required scores or grades in English and Chinese languages



Admission Arrangement (Senior Year Entry)

- To make your application competitive, you need to demonstrate capabilities in **mathematics, programming and communication skills**
- If you are unsuccessful for the Senior Year Entry, you will be considered for the Computer Science and Engineering (BCSEN) First Year Entry with Advanced Standing

Check more details at OAFA's website!

Senior Year Applications:

<http://admission.cuhk.edu.hk/non-jupas-senior/requirements.html>



Curriculum Structure CENG & CSCI



Curriculum – Overview

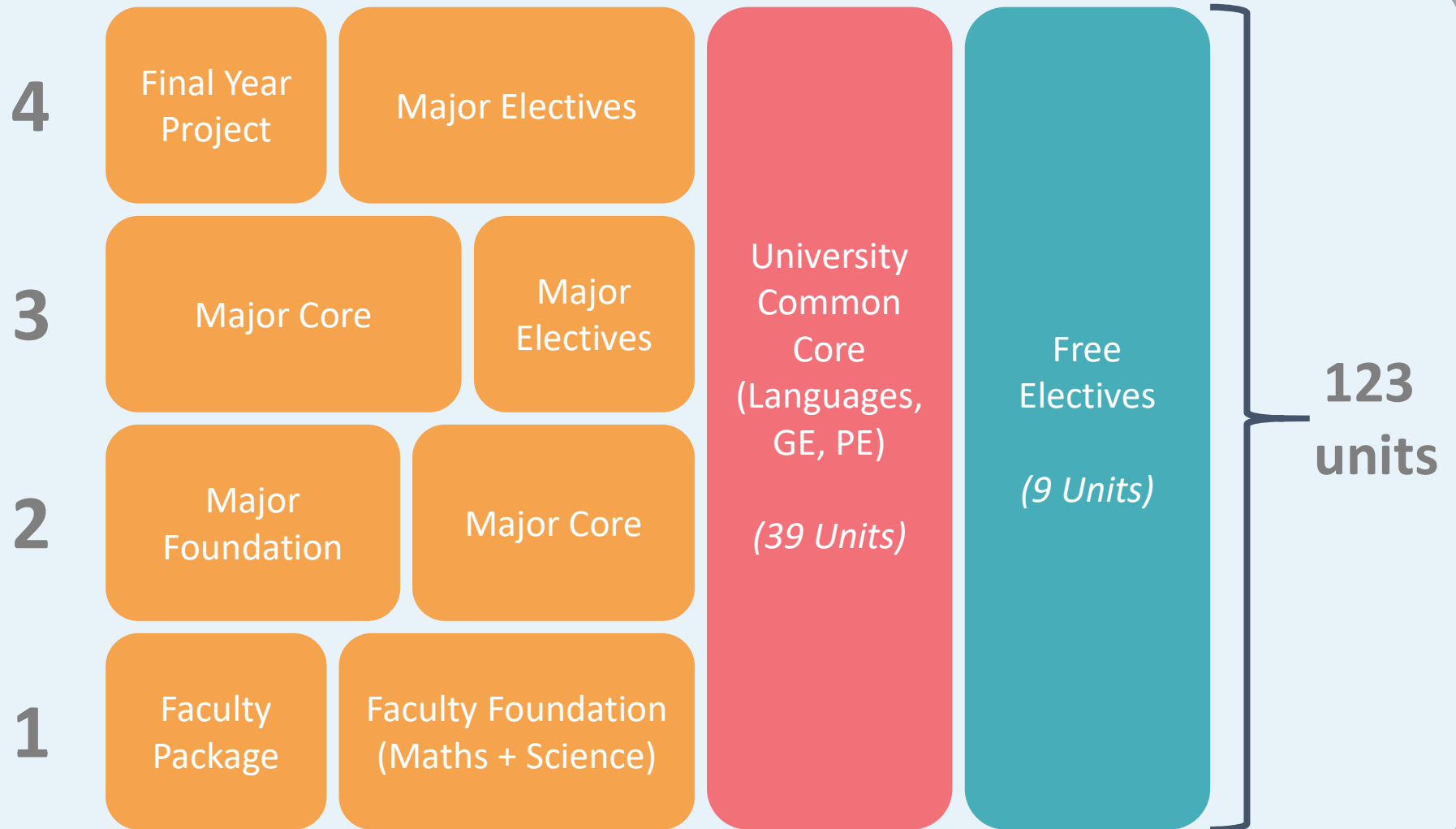

Curriculum – Major Requirements

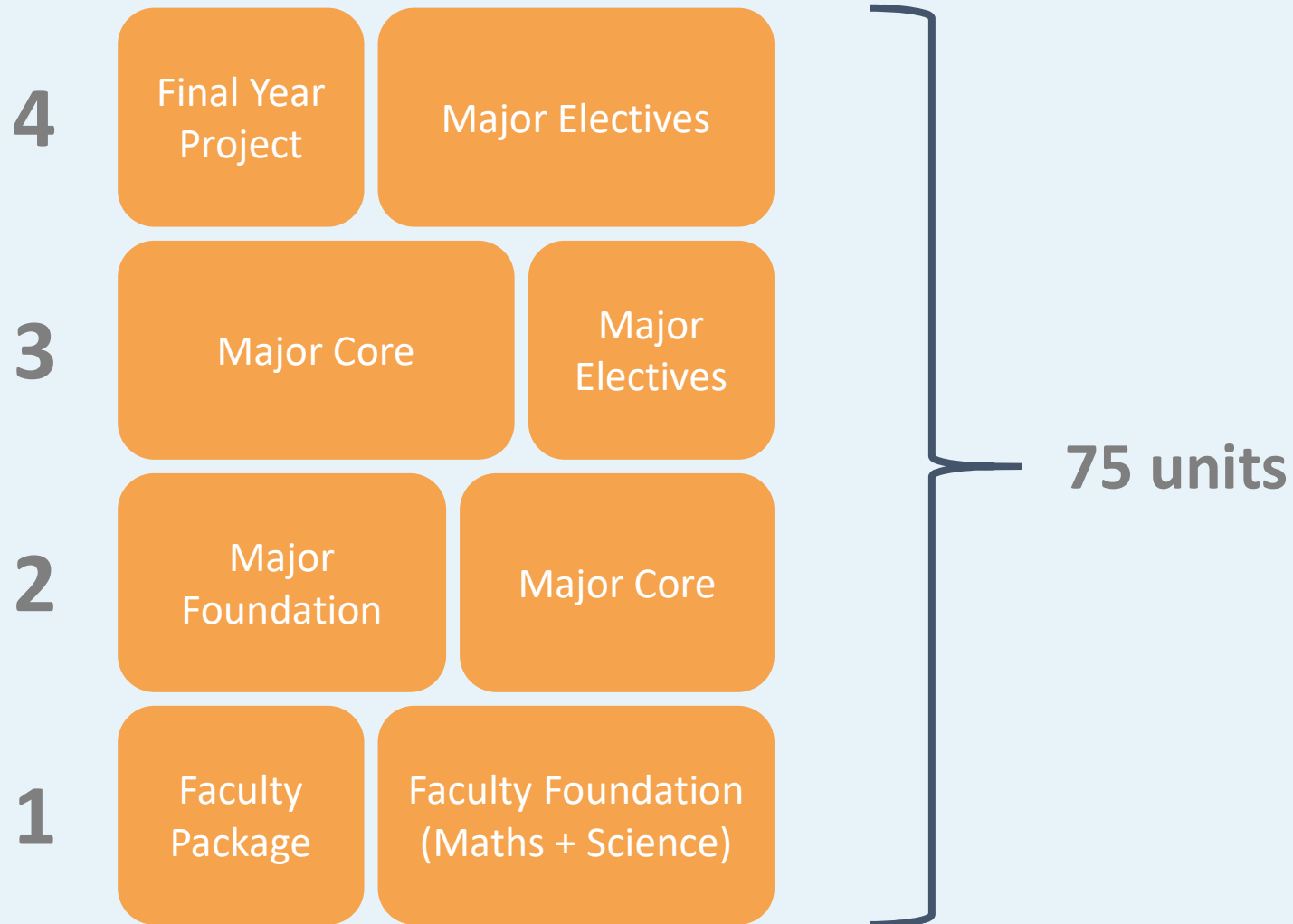

Curriculum – Faculty Package and Foundation

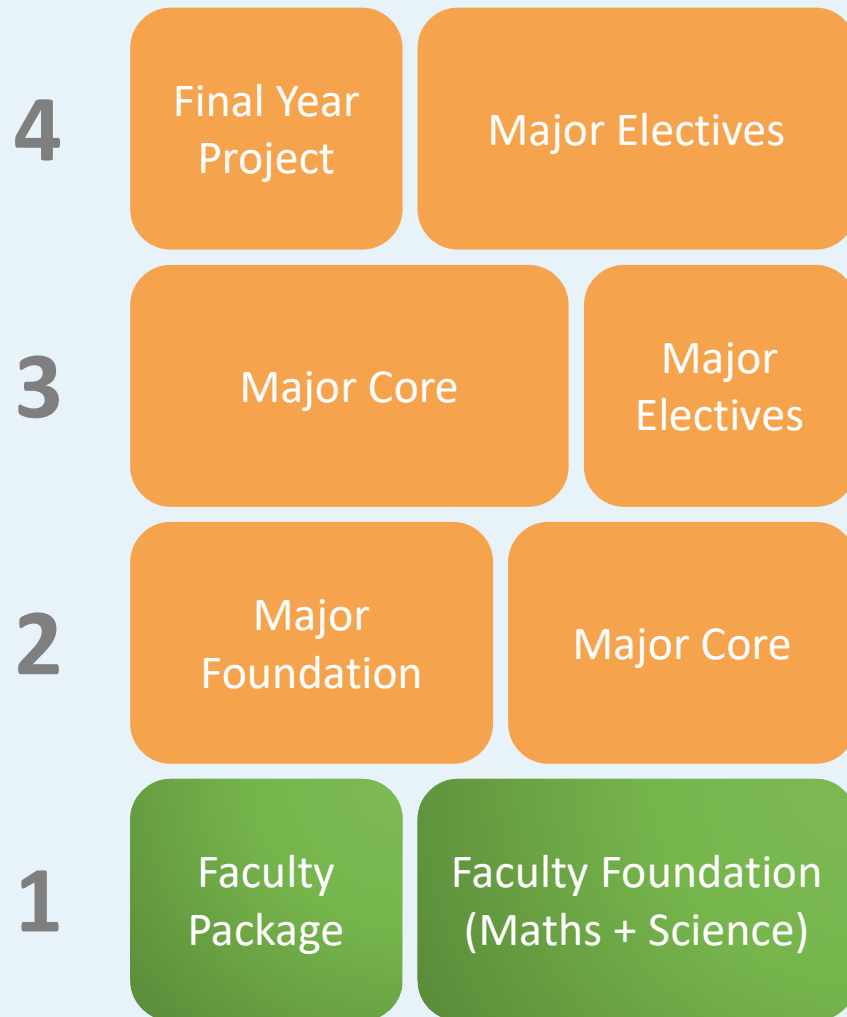

Faculty Package and Foundation (15 units)

- » Problem Solving By Programming (ENGG1110)
- » Linear Algebra for Engineers (ENGG1120)
- » Multivariable Calculus for Engineers (ENGG1130)
- » Calculus for Engineers (MATH1510)
- » Foundation Science

Curriculum – Major Foundation (for CENG)

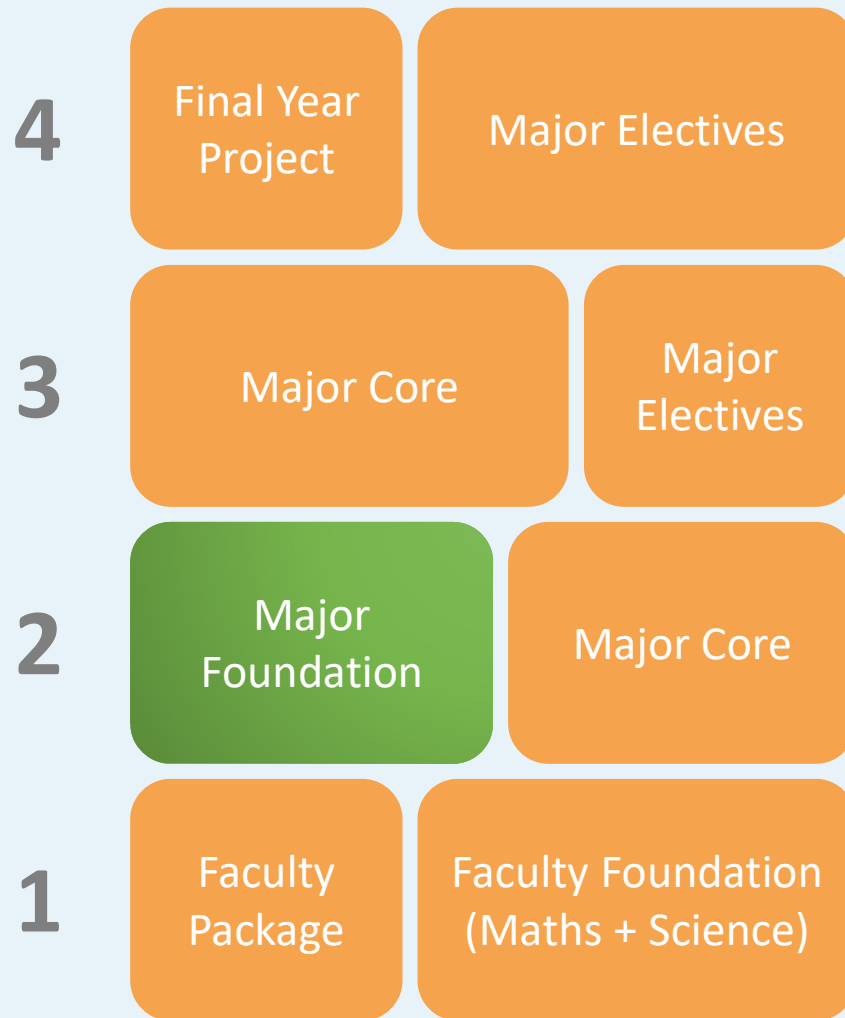

Major Foundation (11 units)

- » Introduction to Computing Using C++ (CSCI1120)
- » Complex Variables for Engineers (ENGG2720)
- » Differential Equations for Engineers (ENGG2740)
- » Probability for Engineers (ENGG2760)
- » Statistics for Engineers (ENGG2780)

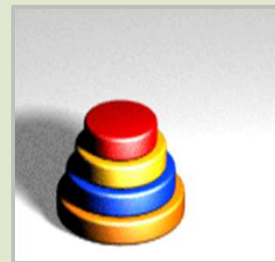

ROLL	DICE CHART	PROBABILITY
2		1/36
3		2/36
4		3/36
5		4/36
6		5/36
7		6/36
8		5/36
9		4/36
10		3/36
11		2/36
12		1/36

Curriculum – Major Core (for CENG)

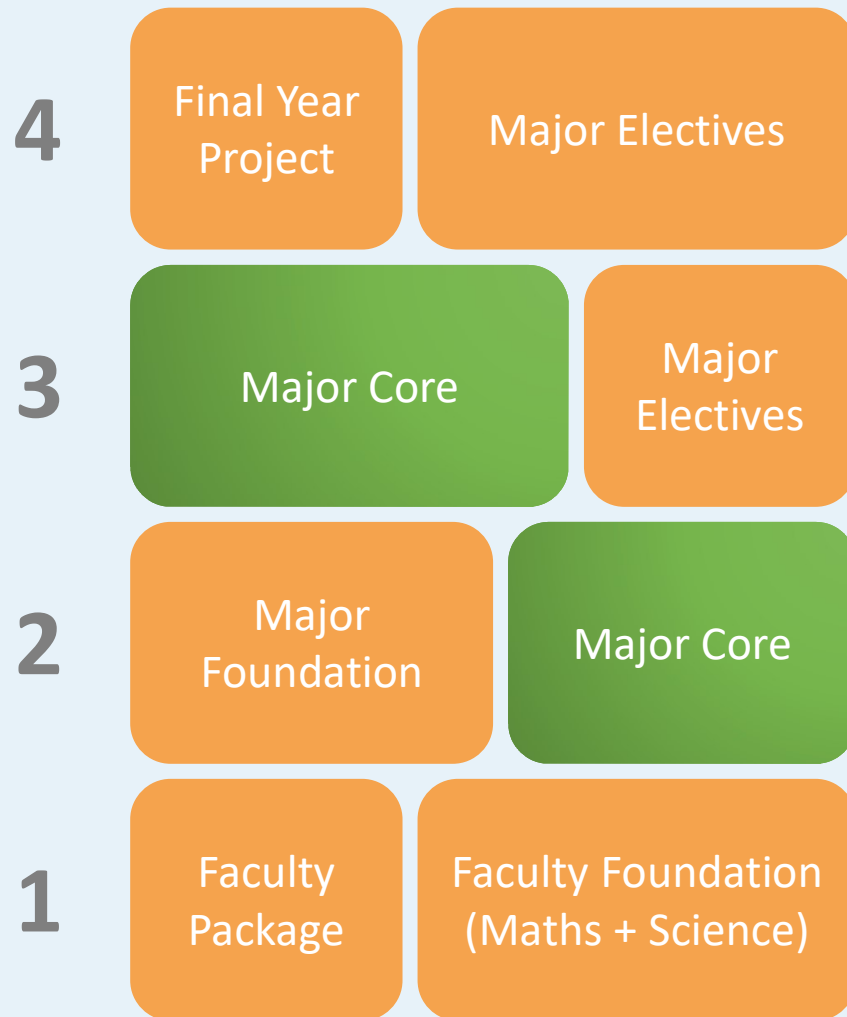

Major Core (31 units)

- » Digital Logic Design Laboratory (CENG2010)
- » Fundamentals of Embedded Systems (CENG2030)
- » Embedded System Design (CENG2400)
- » Computer Organization and Design (CENG3420)



Curriculum – Major Core (*for CENG*)

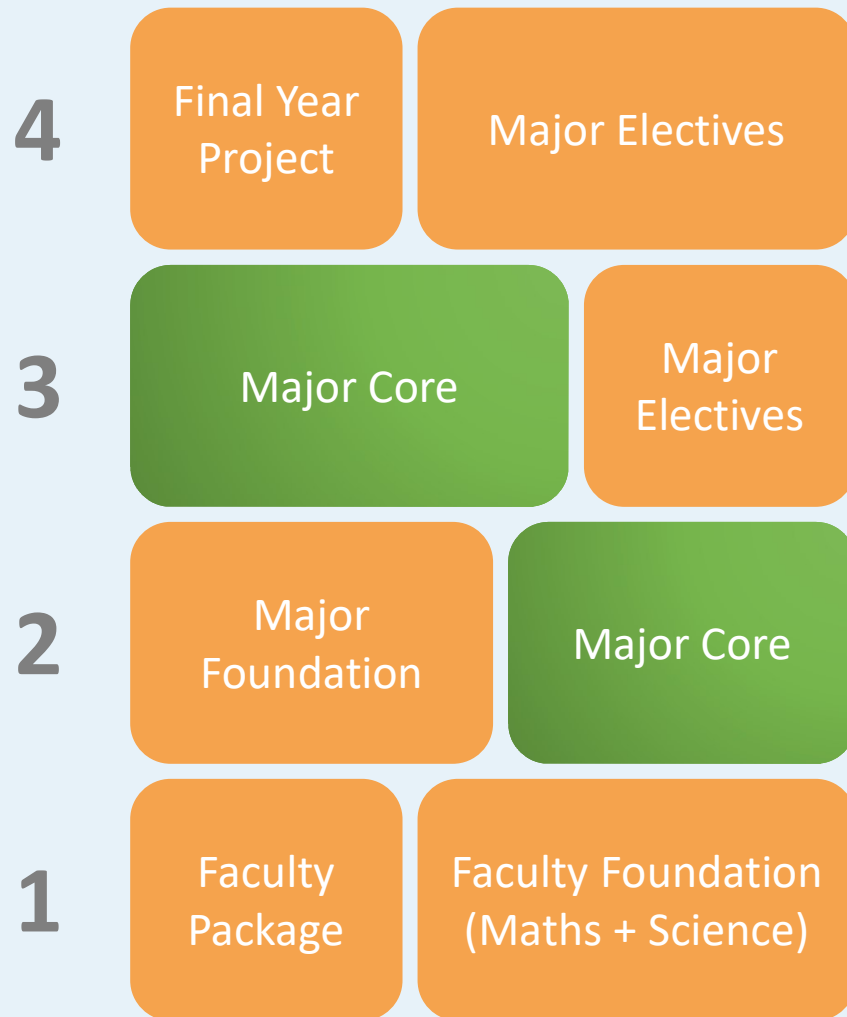

Major Core (31 units)

- » Data Structures (CSCI2100)
- » Software Engineering (CSCI3100)
- » Introduction to Operating Systems (CSCI3150)
- » Introduction to Discrete Mathematics and Algorithms (CSCI3190)
- » Computers and Society (CSCI3250)
- » Engineering Practicum (CSCI3251)

Curriculum – Major Core (for CENG)

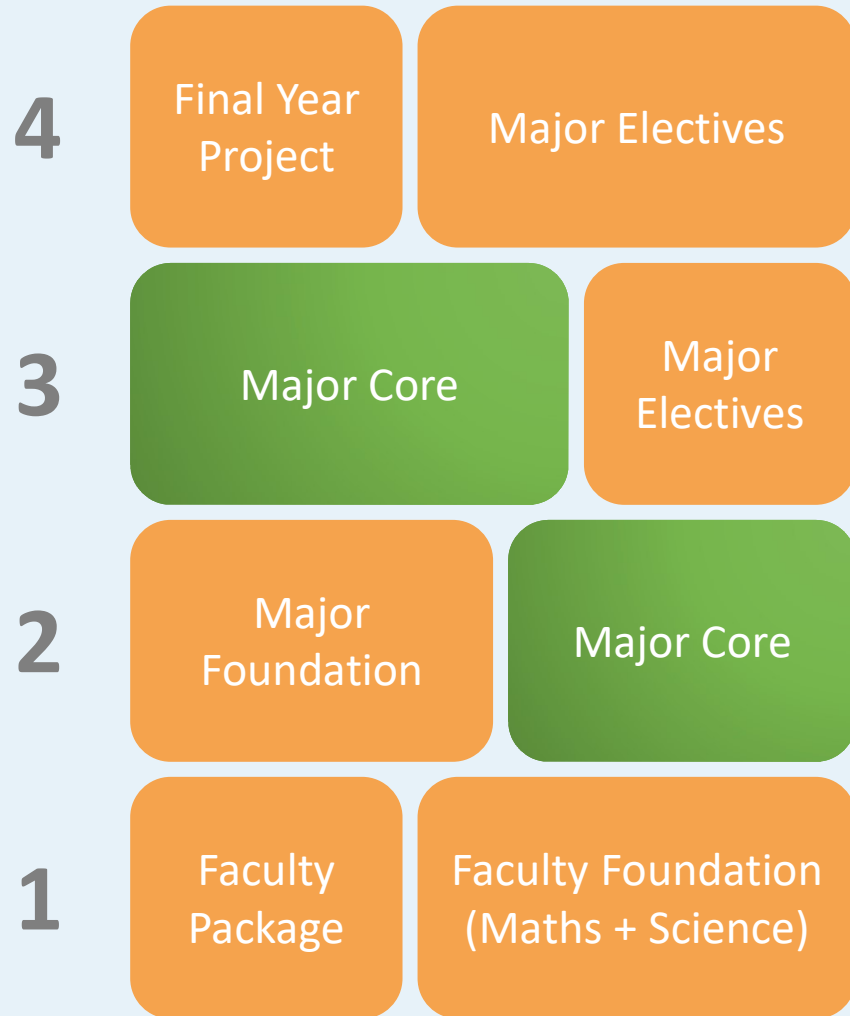

Major Core (31 units)

- » Fundamental of Electric Circuits (ELEG2202)
- » Digital Logic and Systems (ENGG2020)

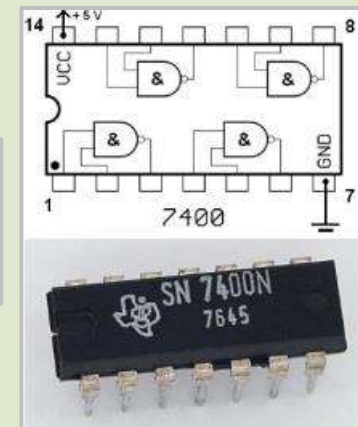
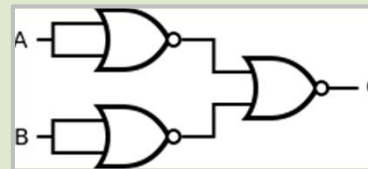

Curriculum – Major Electives (for CENG)

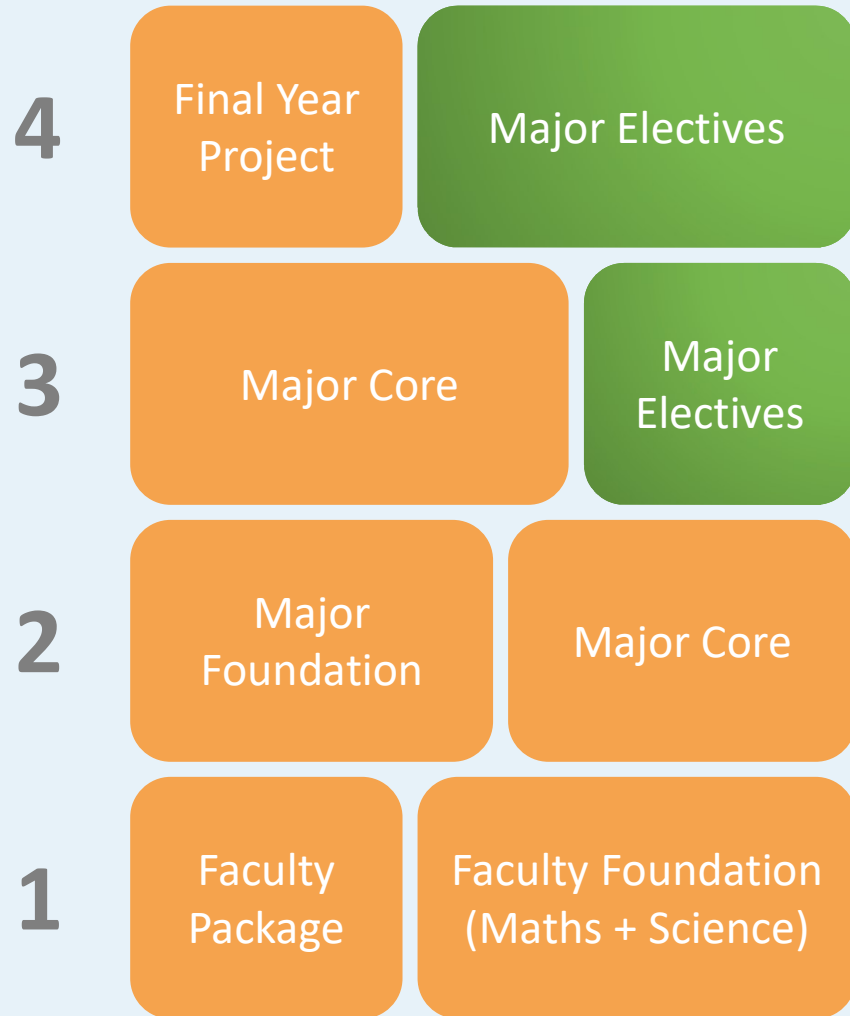

Major Electives (12 units)

Streams

1. Embedded Systems
2. VLSI Design and EDA

Non-Stream

3. General Computer Engineering

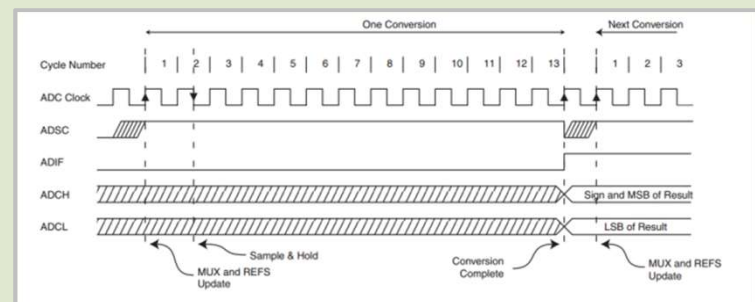

Curriculum – Major Foundation (for CSCI)

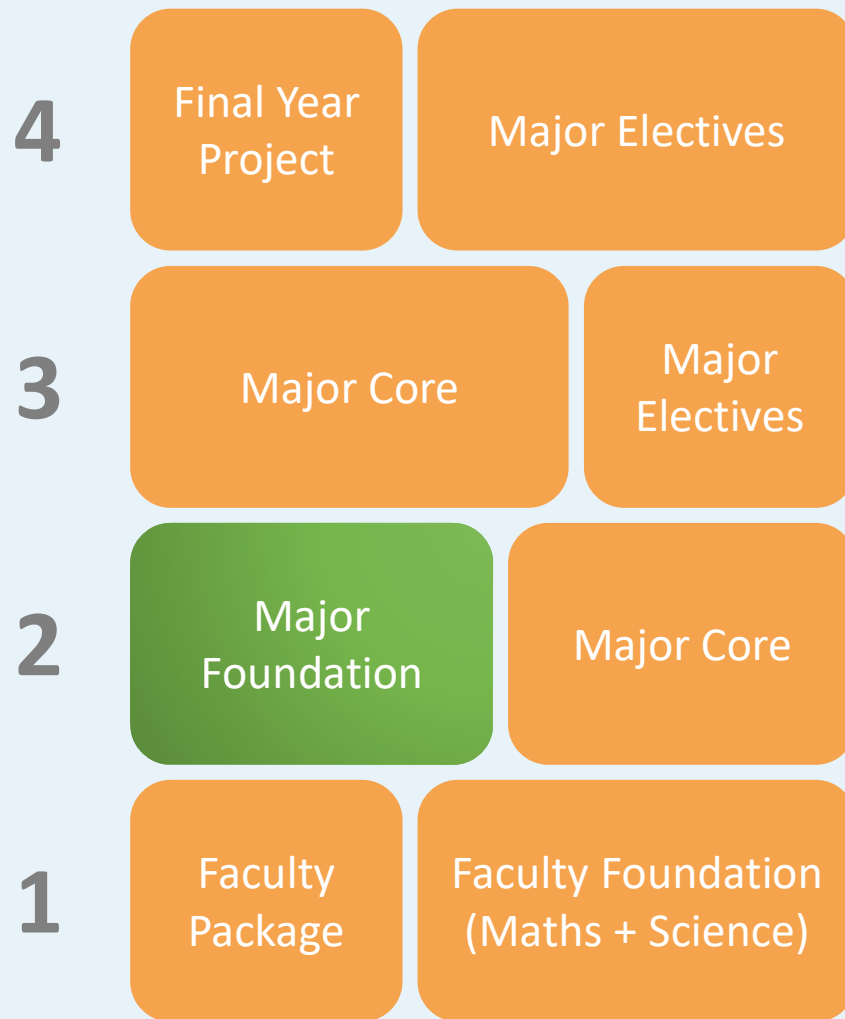

Major Foundation (10 units)

- » Introduction to Computing Using Java (CSCI1130)
- » Discrete Mathematics for Engineers (ENGG2440)
- » Probability for Engineers (ENGG2760)
- » Statistics for Engineers (ENGG2780)

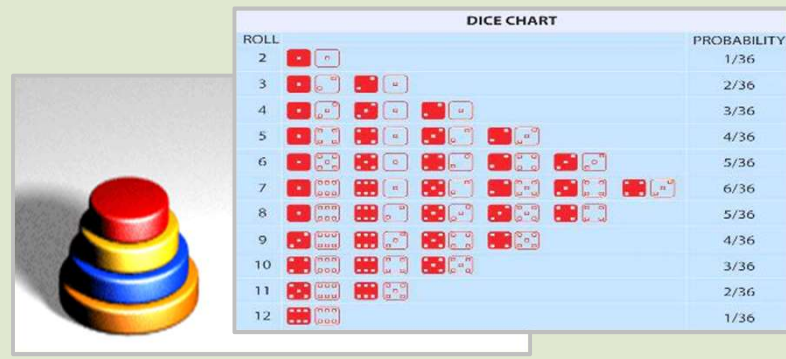

Curriculum – Major Core (for CSCI)

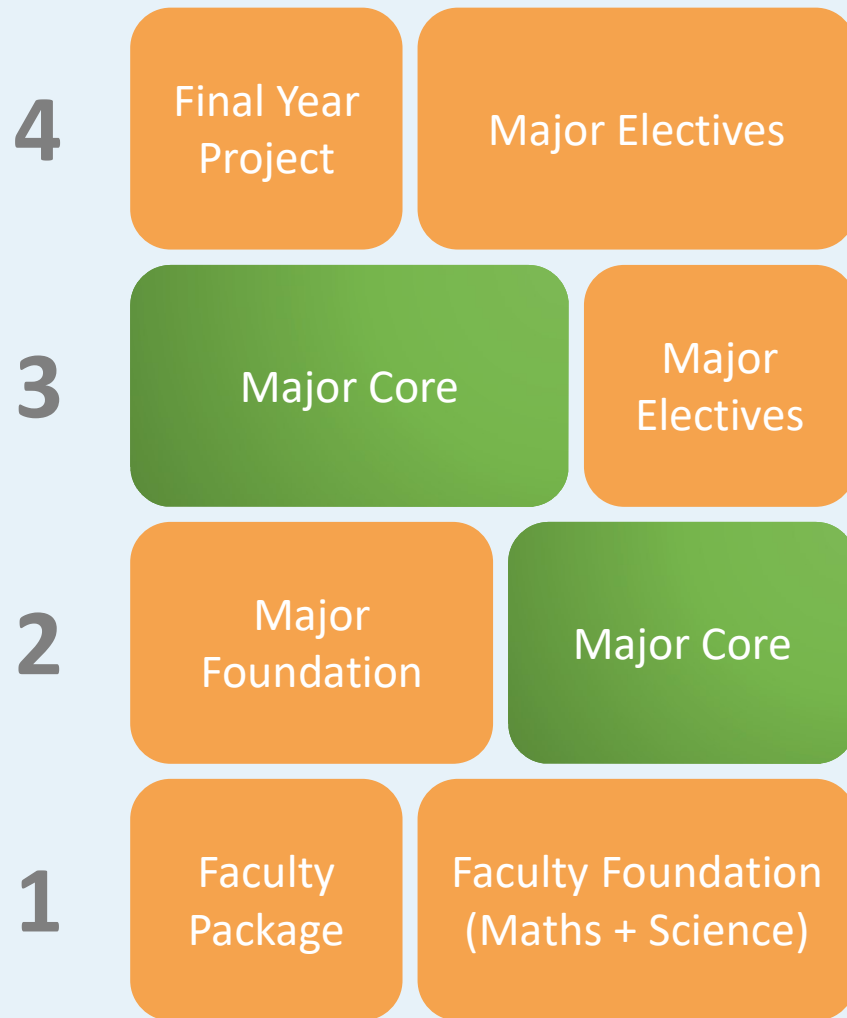

Major Core (27 units)

- » Computer Organization and Design (CENG3420)
- » Data Structures (CSCI2100)

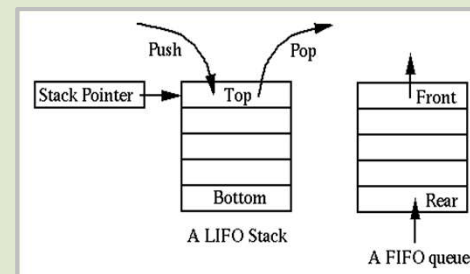
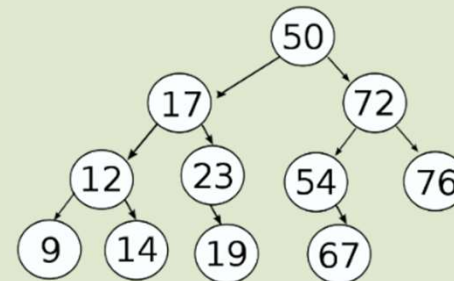

Curriculum – Major Core (for CSCI)

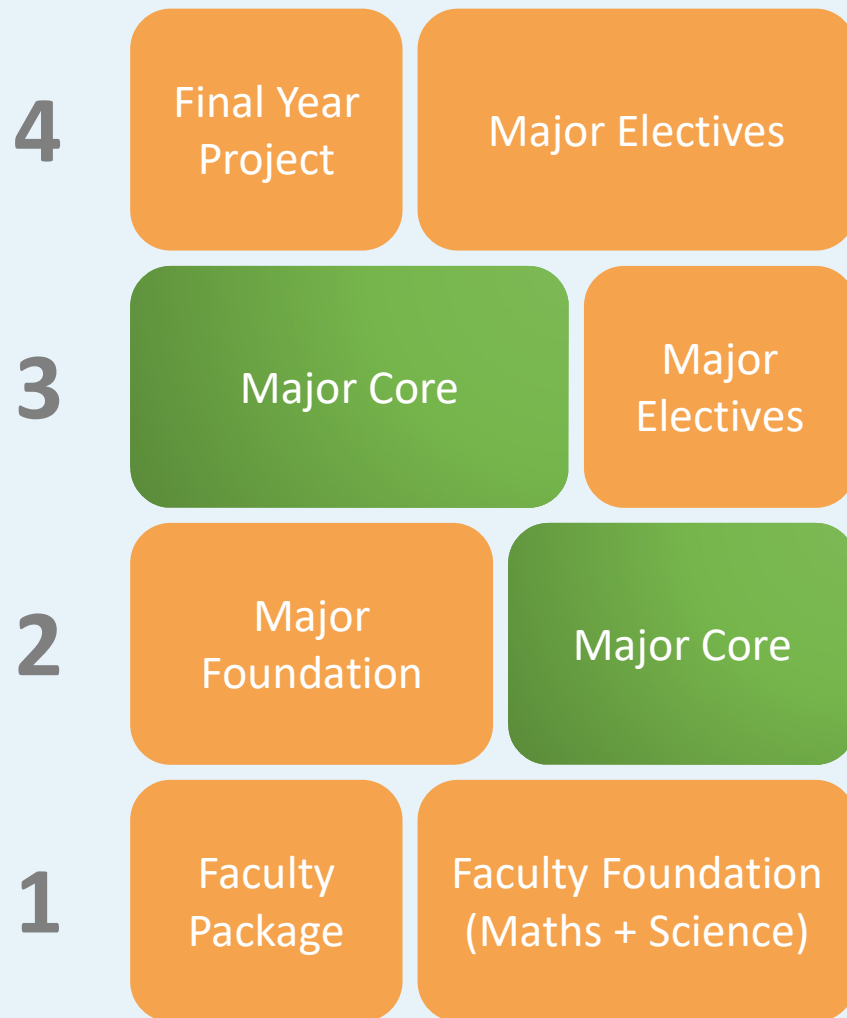

Major Core (27 units)

- » Software Engineering (CSCI3100)
- » Formal Languages and Automata Theory (CSCI3130)
- » Introduction to Operating Systems (CSCI3150)
- » Design and Analysis of Algorithms (CSCI3160)
- » Principles of Programming Languages (CSCI3180)

Curriculum – Major Core (for CSCI)

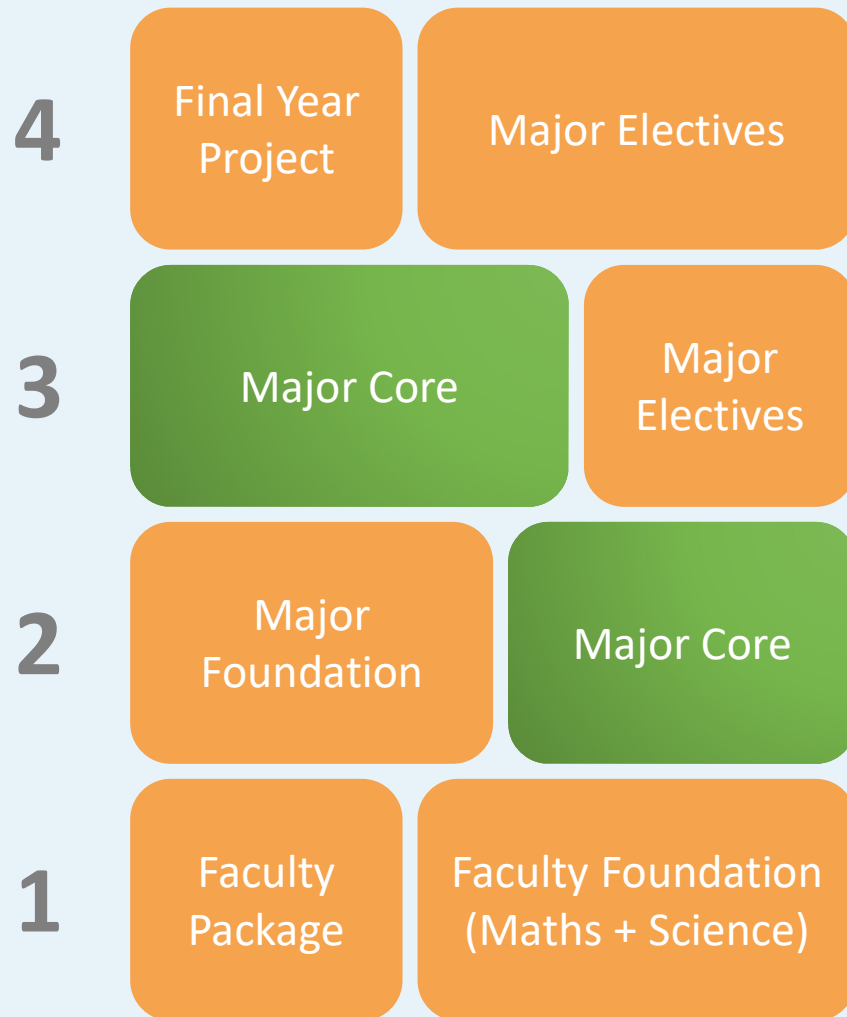

Major Core (27 units)

- » Computers and Society (CSCI3250)
- » Engineering Practicum (CSCI3251)
- » Digital Logic and Systems (ENGG2020)

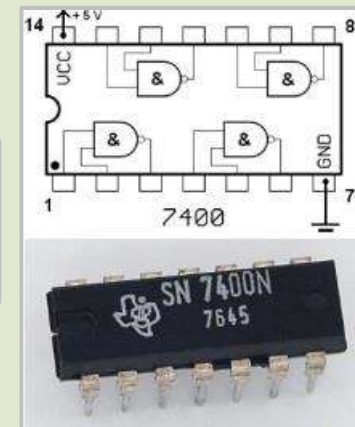
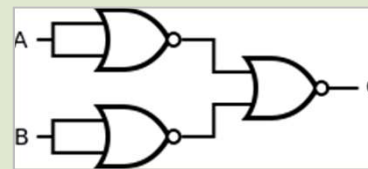

Curriculum – Major Electives (for CSCI)

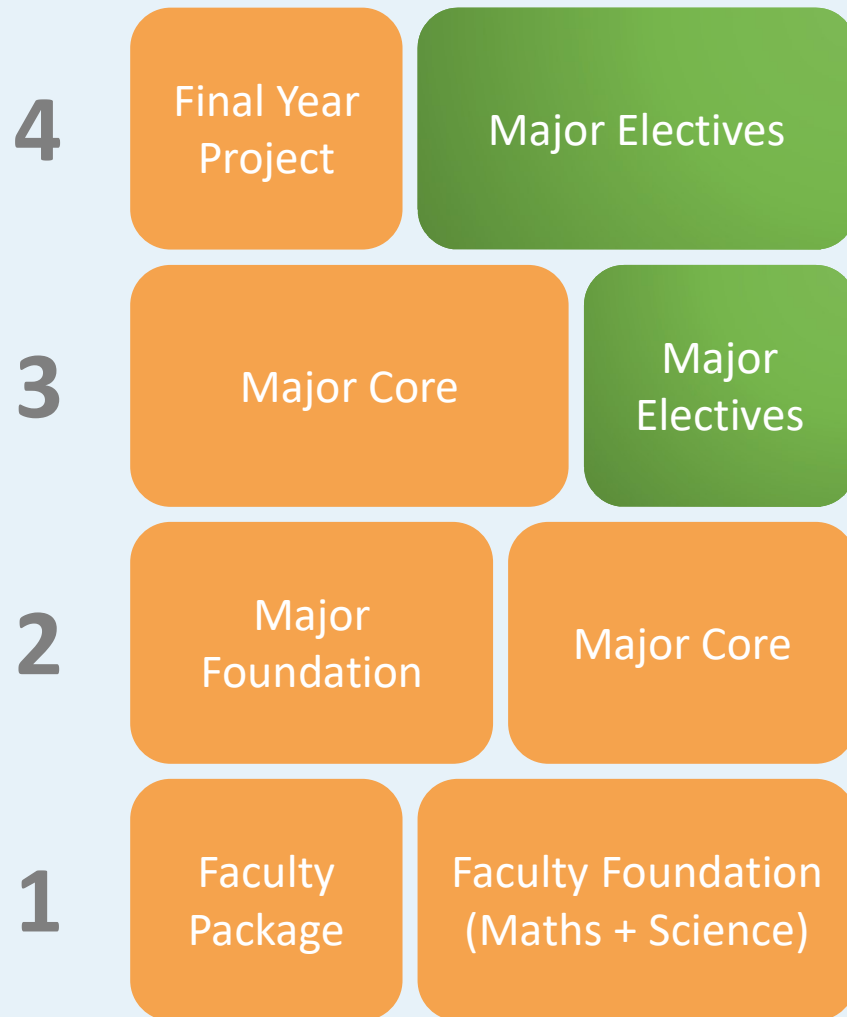

Major Electives (17 units)

Streams

1. Intelligence Science
2. Database and Information Systems
3. Rich Media
4. Distributed Systems, Networks and Security
5. Algorithms and Complexity
6. Data Analytics

Non-Stream

7. General Computer Science

Curriculum – Distinct Topics

- Computer-aided Design for Very Large Scale Integrated Circuits (CENG4120/CENG5030/CENG5270)

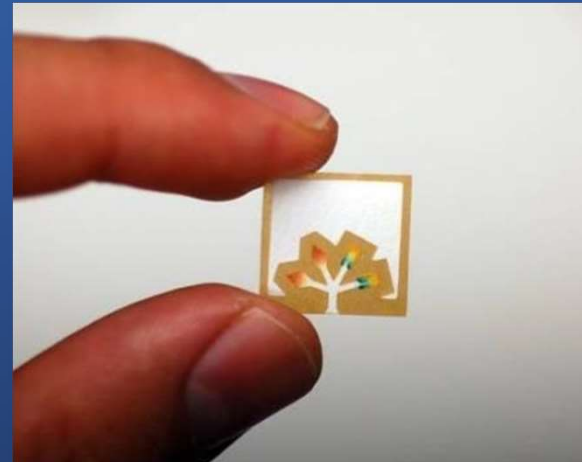
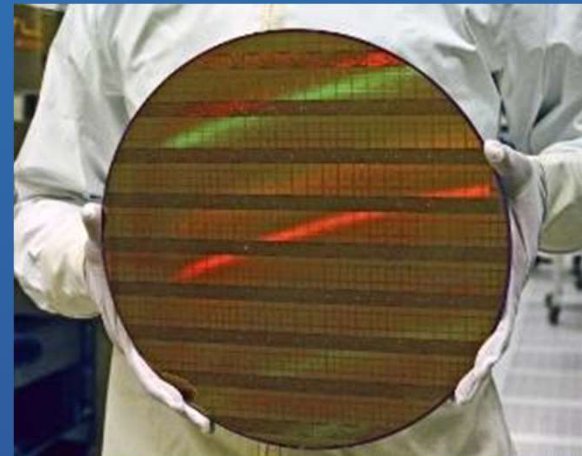
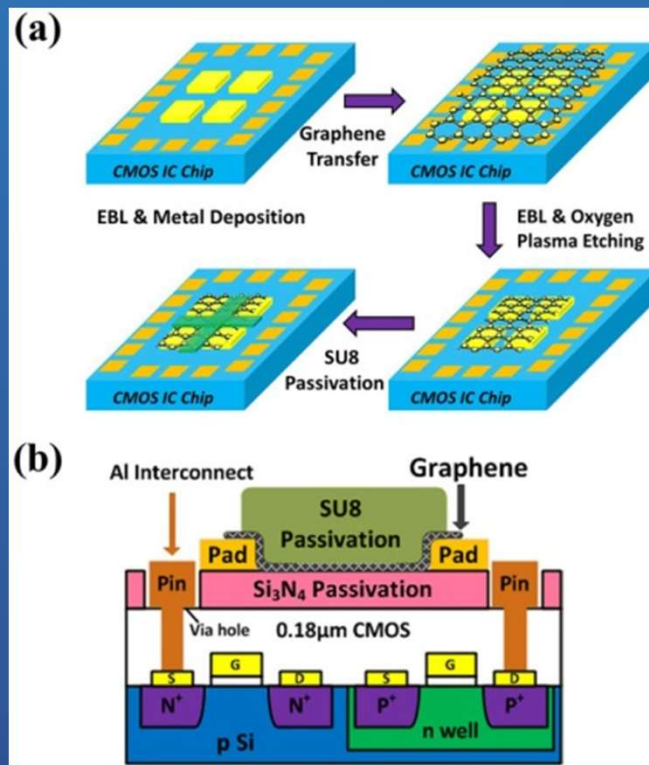

Curriculum – Distinct Topics

- Embedded System Development and Applications (CENG4480)

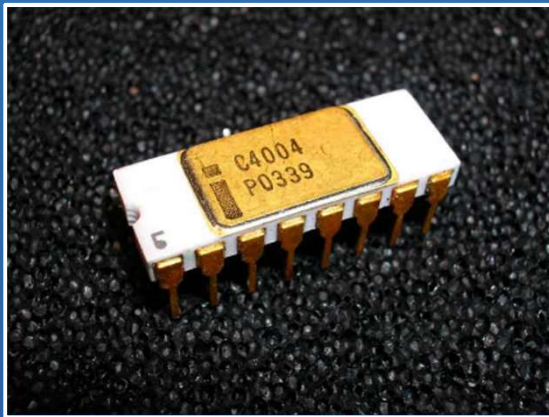

Curriculum – Distinct Topics

- Artificial Intelligence (CSCI3230/ESTR3108)
 - » Create computer software that are capable of intelligent behavior
 - ✓ Searching
 - ✓ Pattern recognition
 - ✓ Genetics algorithms
 - ✓ Artificial neural networks
 - ✓ Deep learning

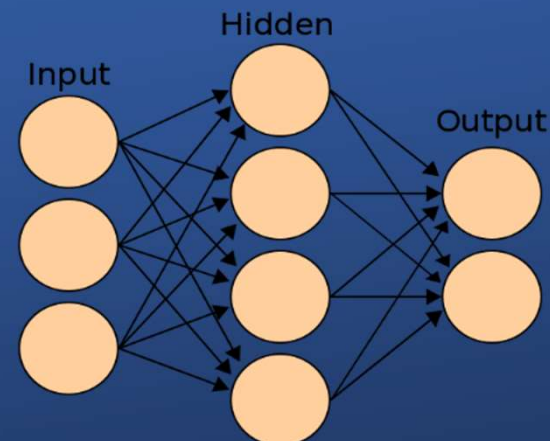
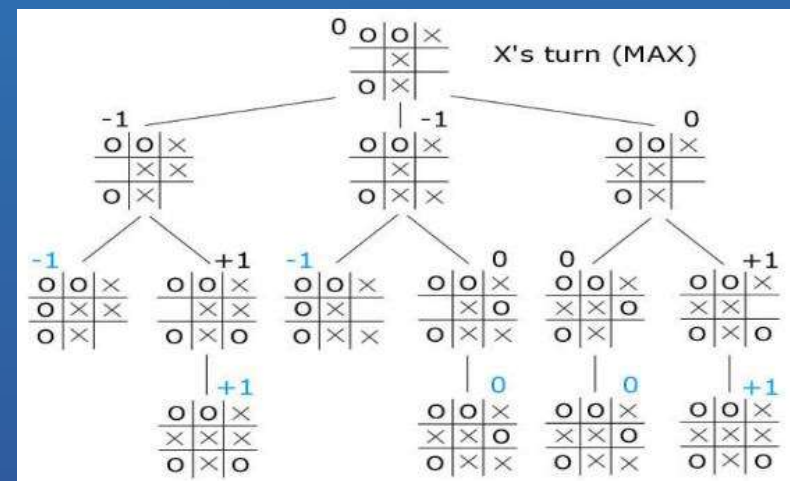
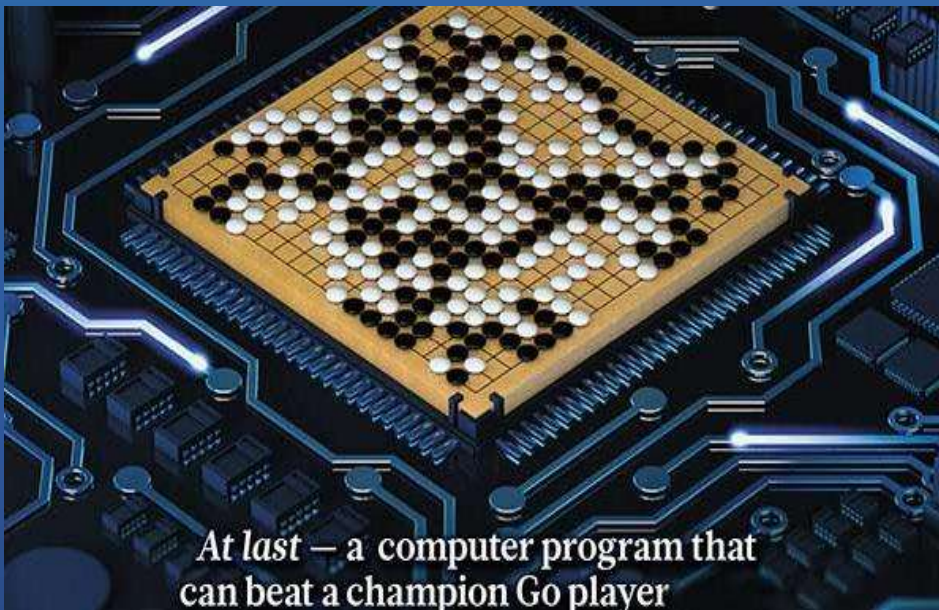

Curriculum – Distinct Topics

- Computer Graphics and Multi-media (CSCI3260/CSCI3280/CSCI3290)

- » Use graphics cards to create photorealistic images and movies

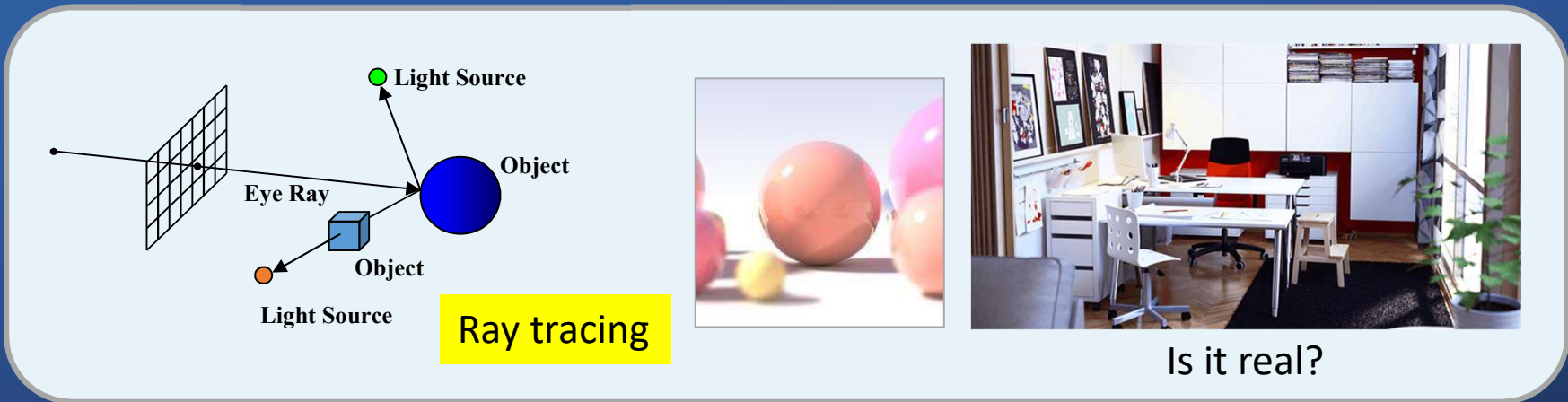
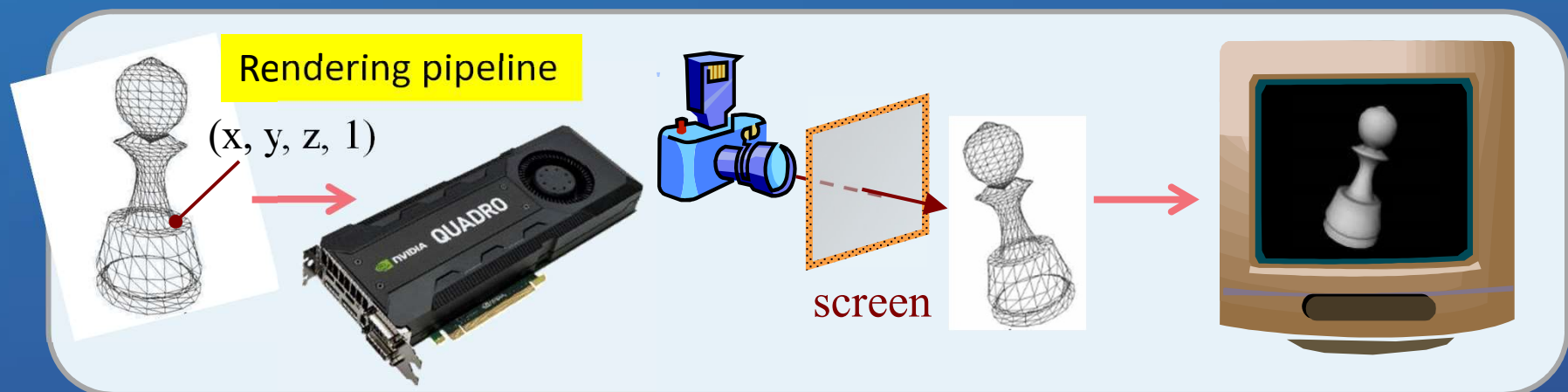

Curriculum – Distinct Topics

- Computer Graphics and Multi-media (CSCI3260/CSCI3280/CSCI3290)

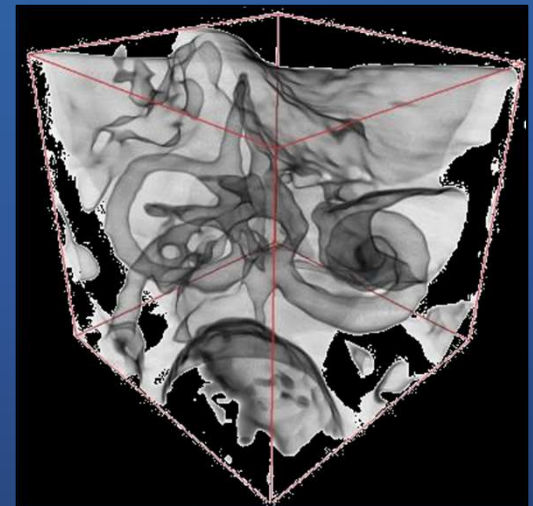

Film & visual effects
& data visualization

Curriculum – Distinct Topics

- Computer Graphics and Multi-media (CSCI3260/CSCI3280/CSCI3290)

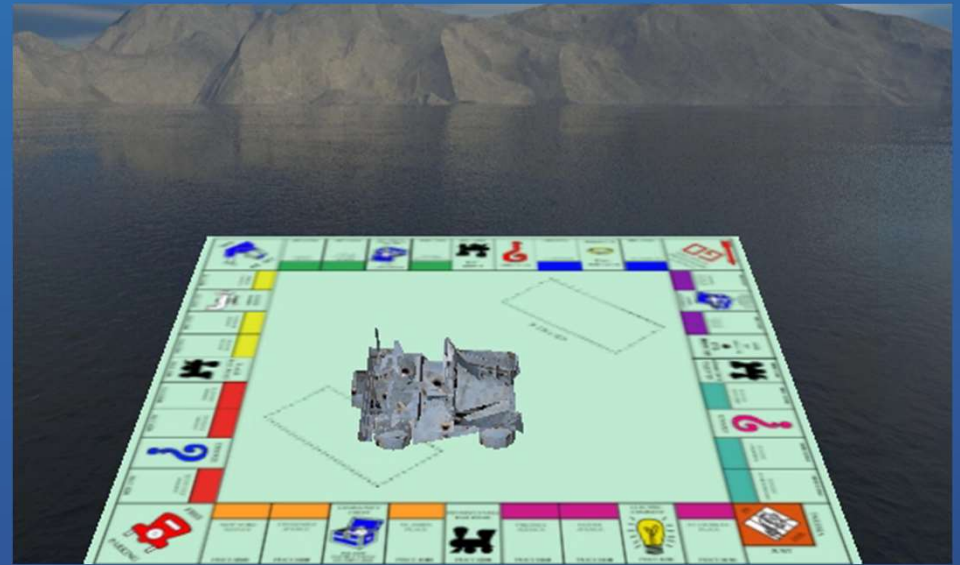
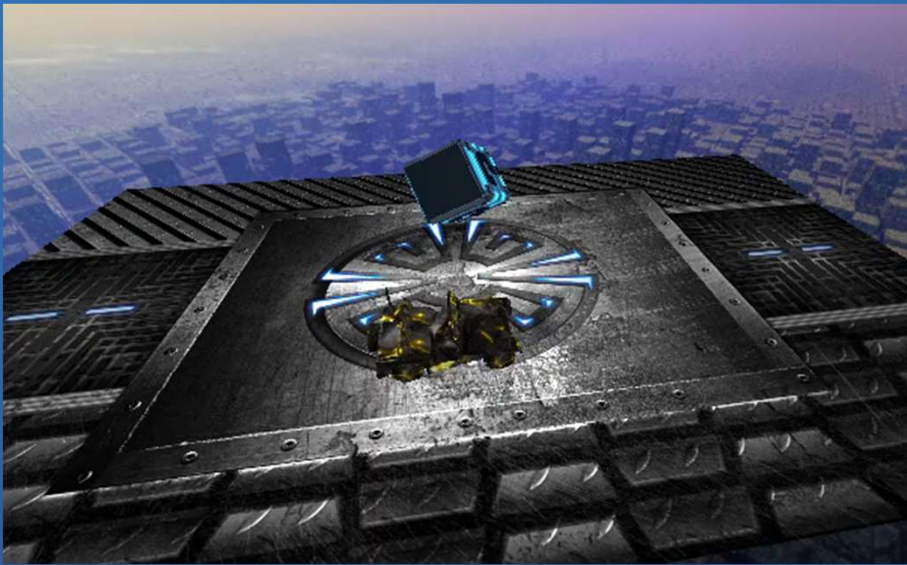

Students' course projects

Curriculum – Distinct Topics

- Computer Game Software (CSCI4120)

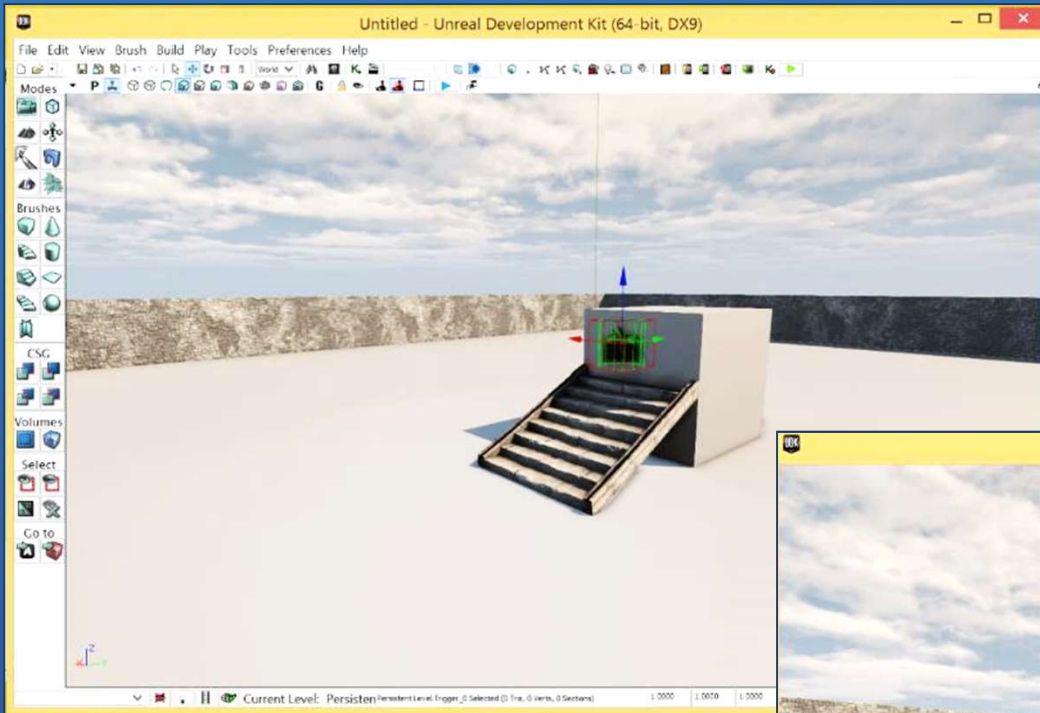

Learn how to
develop a game



Curriculum – Distinct Topics

- Computer Game Software (CSCI4120)



Students' course projects



Curriculum – Distinct Topics

- Algorithms for Bioinformatics (CSCI3220)
 - » Use computer to model and interpret biological data
 - » DNA mutation \leftrightarrow diseases

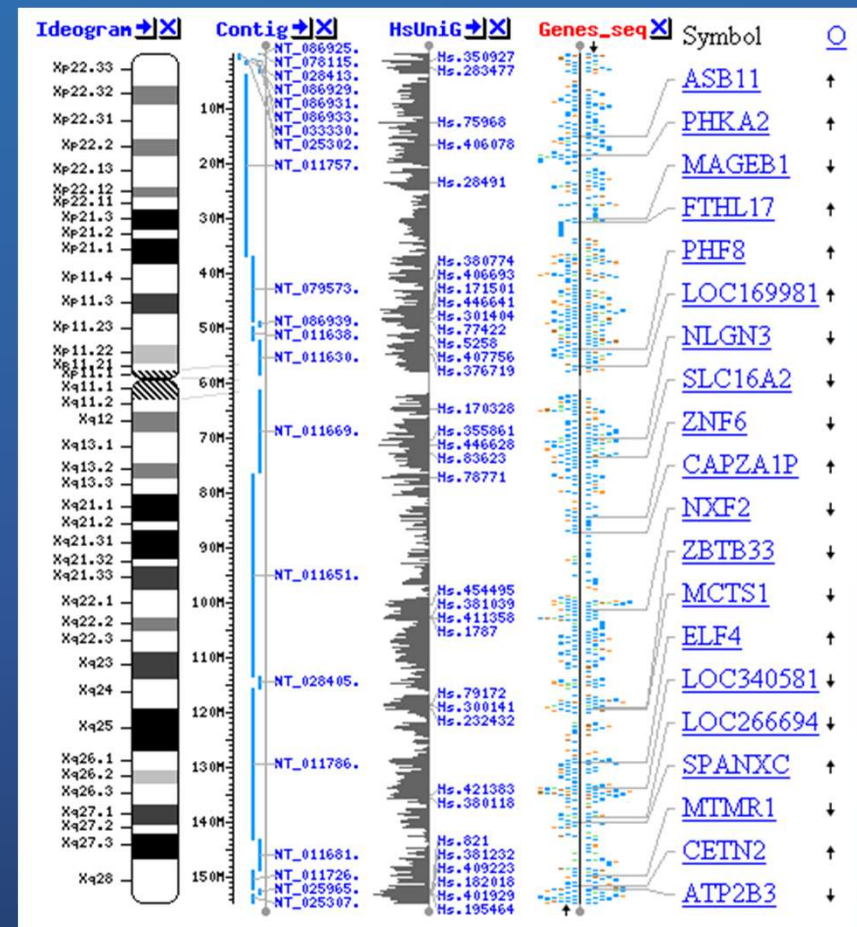
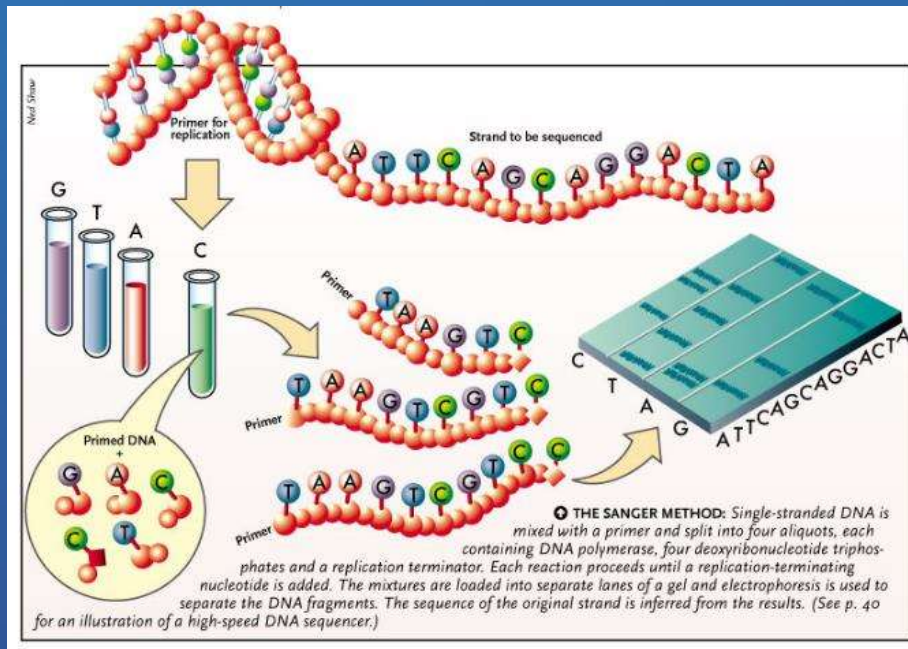

Curriculum – Distinct Topics

- Big Data Analytics and Machine Learning (CSCI3170/CSCI3320/CSCI4180/CSCI5510)

ATCGAATTCCATAATC
ATTATCGAACTTACGA
AATTTACAATCAATCG

Data



Knowledge



ATCGAATTCCATAATC
ATTATCGAACTTACGA
AATTTACAATCAATCG

Patterns



Information

Fast and
Efficient



Curriculum – Distinct Topics

- Many other practical and interesting courses:
 - » Algorithms
 - » Cloud Computing
 - » Computational Finance
 - » Computer and Network Security
 - » Databases
 - » Energy Efficient Computing
 - » Networks
 - » Operating Systems
 - » Rapid Prototyping of Digital Systems
 - » Smart Hardware Design
 - »



Curriculum – Final Year Project (FYP)

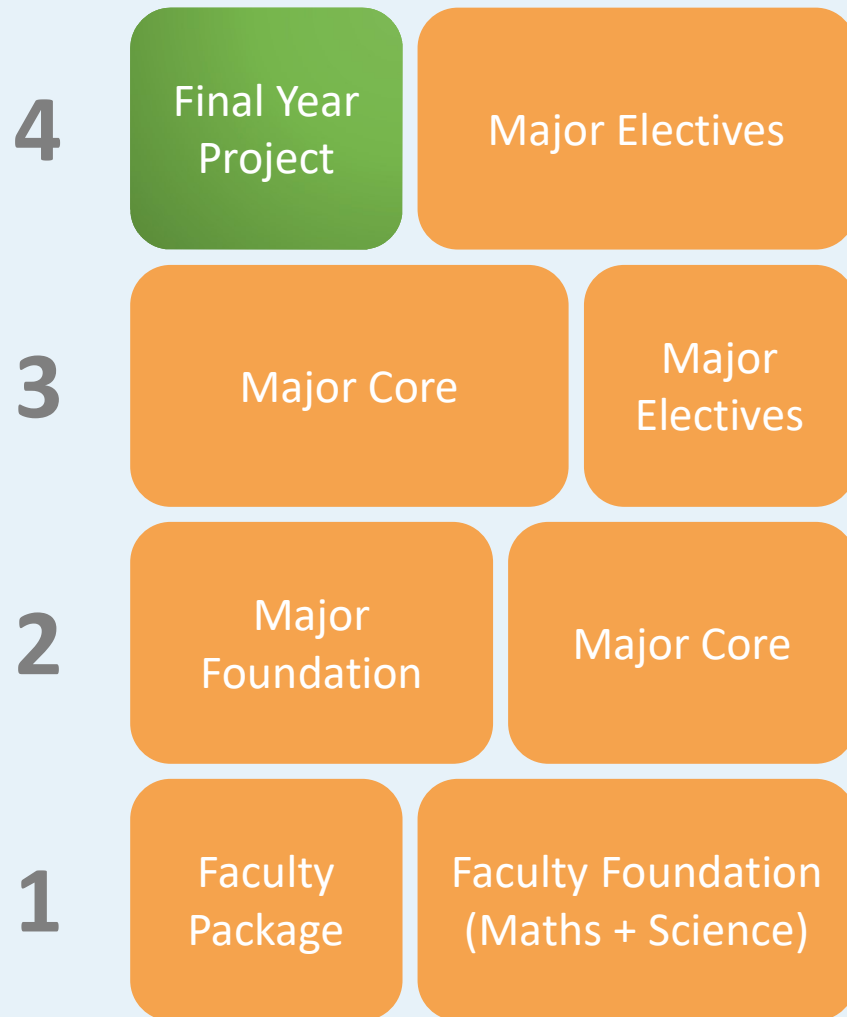

Final Year Project (6 units)

- » Pick an interesting topic
- » Interdisciplinary nature
- » Apply the knowledge learnt in the previous courses
- » Many open topics. Your creativity and discussion with the supervisor
- » Complete a project under the supervision of an advisor

Open topic FYP – you may also propose a project to a professor

FYP (AI + Bioinformatics)

- Apply machine learning to predict RNA-protein interaction

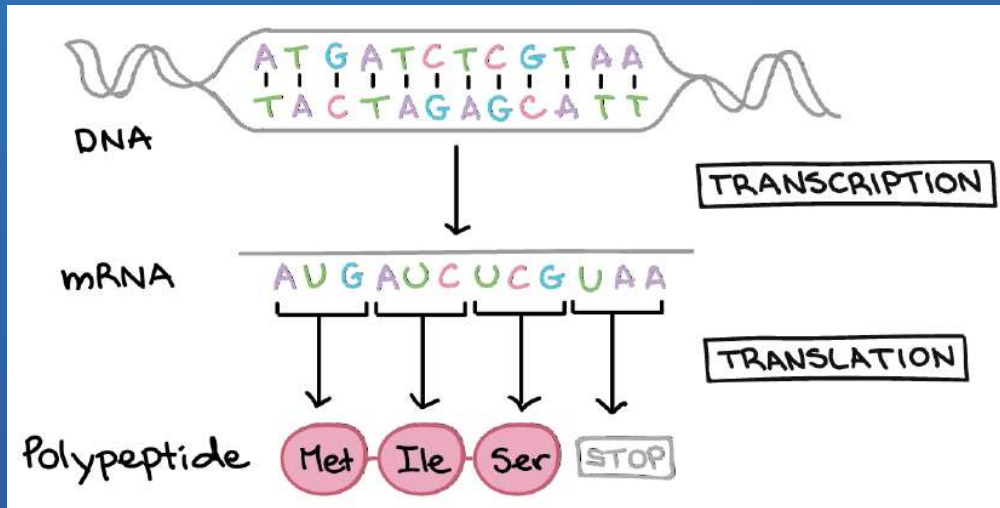

RNA-binding protein (RBP)

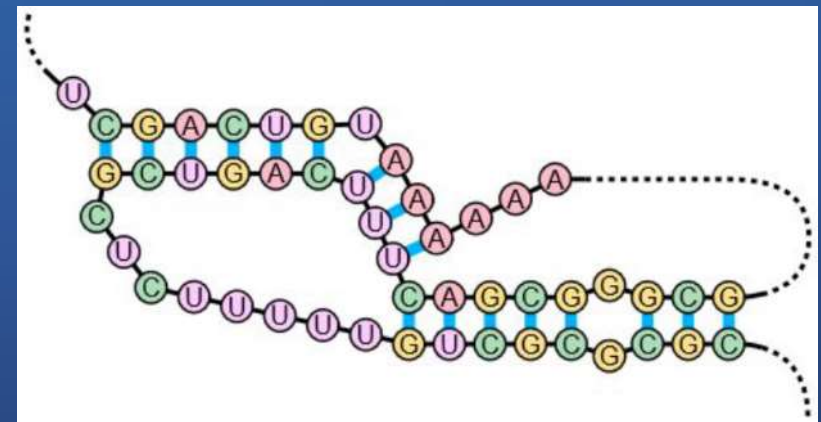
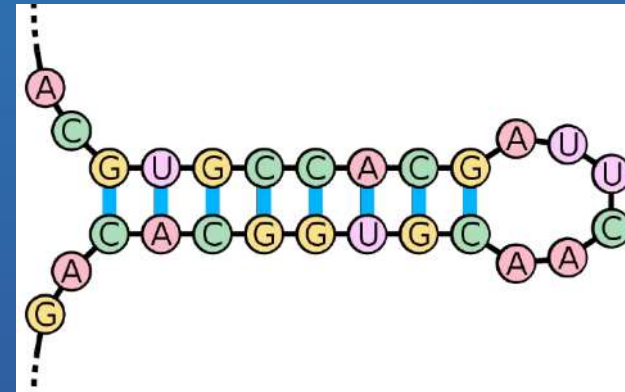

RNA folds to a specific structure to fit into the protein binding site

FYP (AI + Multimedia)

- Design a neural network that learns to produce a tiling

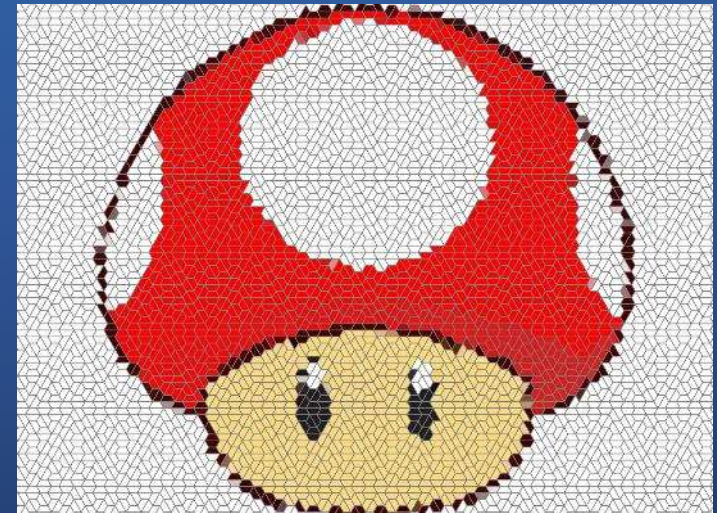
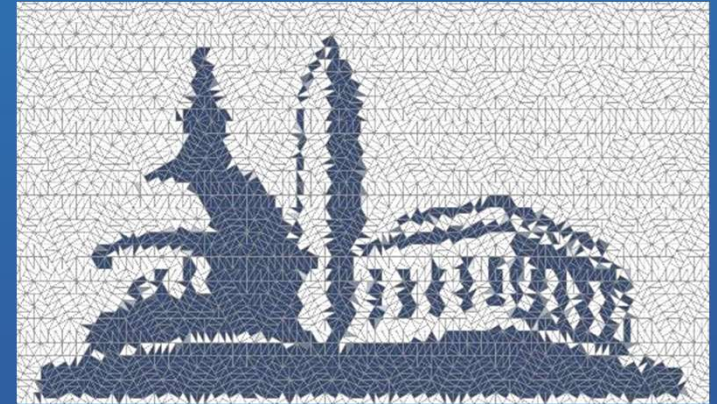
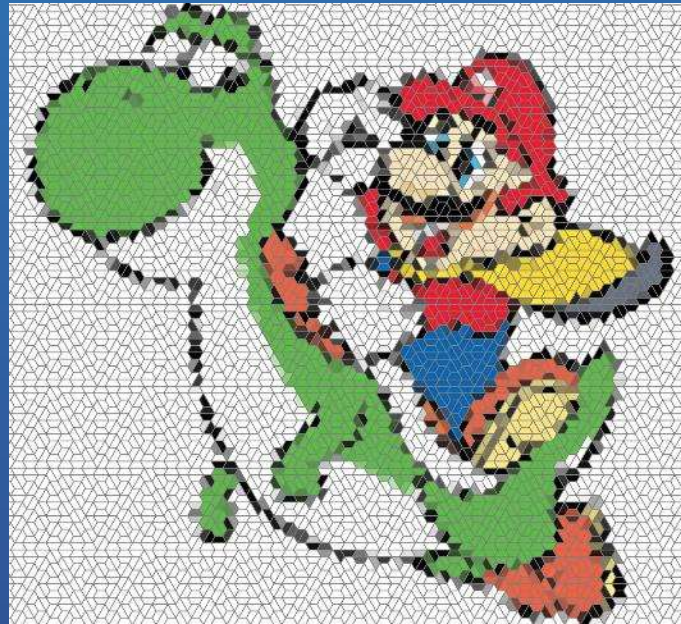
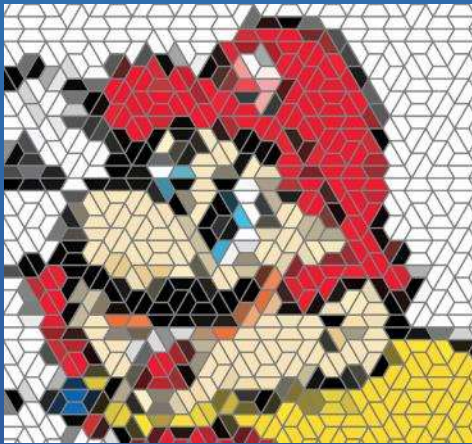

FYP (AI + Computer Vision)

• Chinese Medicinal Herb Recognizer

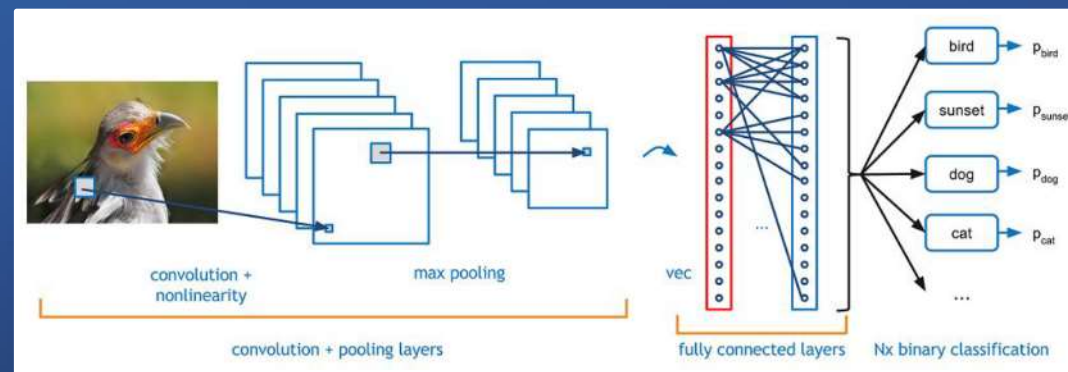
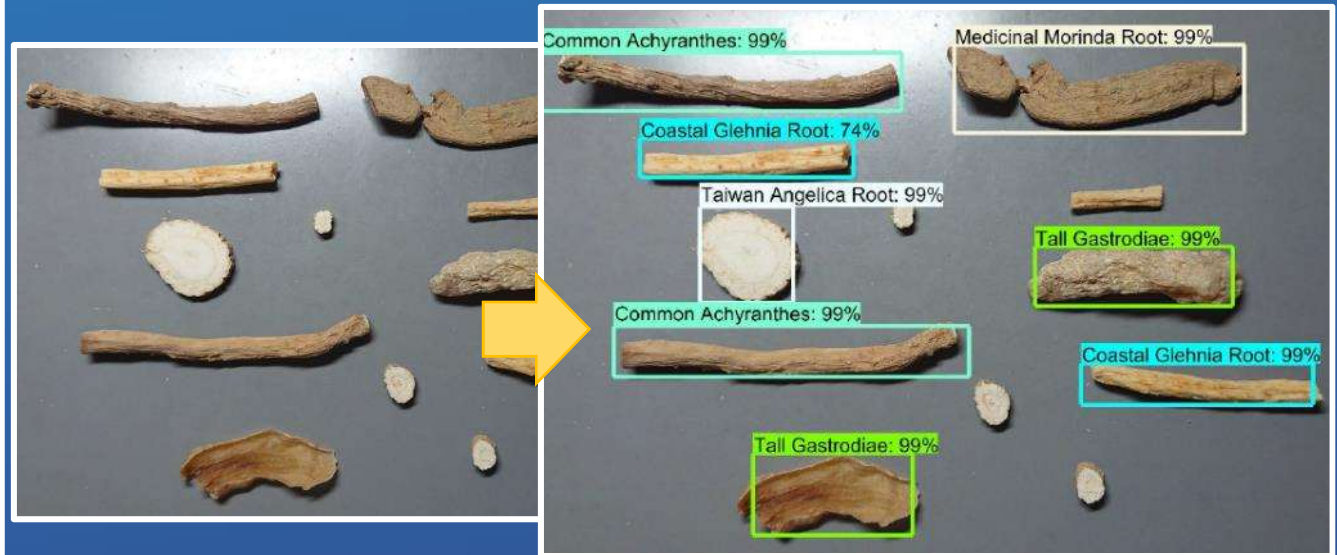
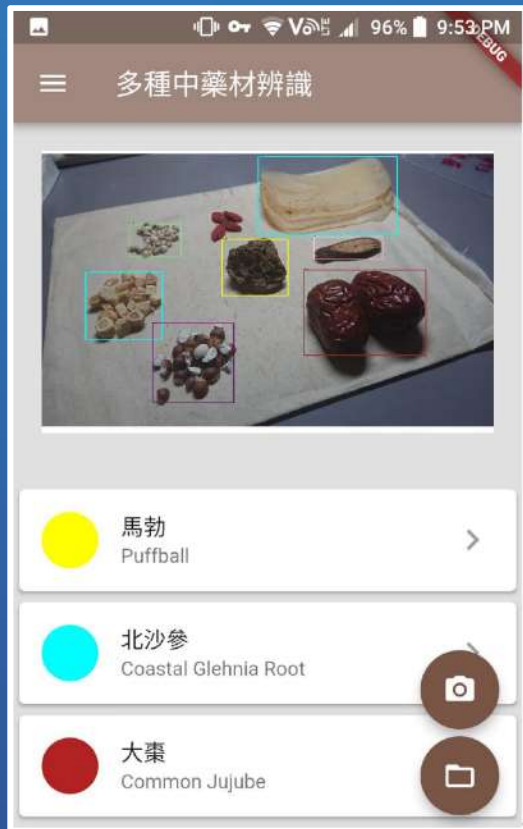

From FYP MHW1804

FYP (Self-driving Robots)

- Controls: Serial, Bluetooth, and Raspberry Pi, *etc.*

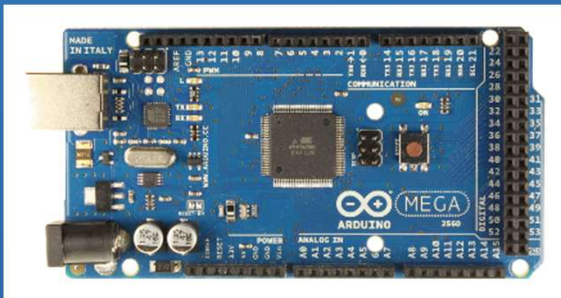

Arduino Mega 2560



Raspberry Pi 3b+

From FYP MCY1801



Camera module

PiCamera &
Raspberry Pi &
Servo Motors



Motor
Drivers &
Stepper
Motors

Arduino Mega
2560 & Power
Supplies & Motor
System

FAQs



FAQ Contents:

Q: Will there be any interview?

Q: What is Major Allocation?

Q: Computer Engineering (CE) or Computer Science (CS) ?

Q: How many students will be admitted to BCSEN in 2023-24?

Q: Will there be any exchange opportunity?

Q: Will there be any scholarship or financial aid?

Q: What are the career prospects of CENG/CSCI graduates?

Q: What is ELITE Stream? How can I join it?

Q: Can I transfer to AIST or other majors in Year 2?

Q: Can I declare AIST / CSCI / CENG as second major or minor?

Q: I am still struggling to choose AIST / CSCI / CENG.

What can I do?



**Q: Will there be any
interview?**



Interview Arrangement for JUPAS students

- We plan to arrange interviews in **mid-/late June** every year.
- We only consider **Band A applications** for shortlisting.
- Shortlisted applicants will receive an invitation email for the details, *e.g., date, time, format, etc.*
- Stay tuned! **Check your email** regularly for the latest update!

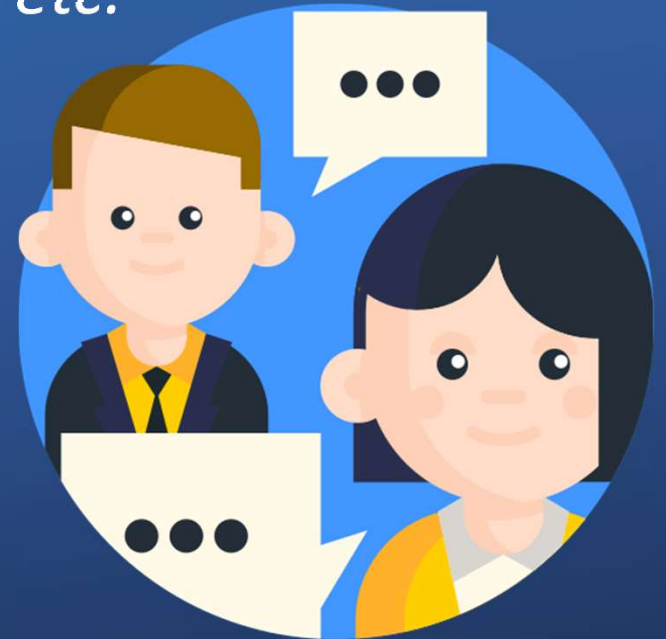

Interview Arrangement for Non-JUPAS and International Students

- Interviews will be conducted **in batches from January** every year.
- You are encouraged to **attach adequate supporting documents, e.g., transcripts, predicted grade, certificates, etc., in your application** for our holistic review.
- Shortlisted applicants will receive an invitation email for the details, *e.g., date, time, format, etc.*
- Stay tuned! **Check your email** regularly for the latest update!

Q: What is Major Allocation?



Major Allocation

- Students will be allocated into one of the major programmes after Year 1
 - » Computer Engineering (CENG)
 - » Computer Science (CSCI)
- Students with **outstanding entry grades / scholarships** and **good academic performance** in their first year of study are guaranteed their first choice of major
- It is expected that a relatively **high** percentage of students would be allocated to their preferred major.

**Q: Computer Engineering (CE)
or Computer Science (CS) ?**



Difference between CENG and CSCI

- **Computer Engineering** is more about **building things**
 - » To take care of design and hardware/software integration (*e.g.*, lower cost, higher speed, more energy efficient)
- **Computer Science** is more about **designing software solutions**
 - » To take care of coding, software architecture, and the underlying theory



**Q: How many students
will admit to BCSEN
in 2023-24?**



Intake Quota

- BCSEN (JS4412):
Computer Science and Engineering
Intake Quota: **107**



For more details:

<https://dse.bigexam.hk/zh-hk/pathway/progs/jupasProg/JS4412>

**Q: Will there be any
exchange opportunity?**



Exchange to Overseas Universities

- You are encouraged to join the exchange programme to **broaden your horizon** and **learn with peers from diverse background**
- List of some overseas universities for the exchange
 - » Macquarie University, Australia
 - » University of Toronto, Canada
 - » Shanghai Jiao Tong University, China
 - » Telecom & Management SudParis, France
 - » Royal Institute of Technology (KTH), Sweden
 - » University of California, Davis, USA
 - ...



Submit your application via [Office of Academic Links \(OAL\)](#)!

Q: Will there be any scholarship or financial aid?



Scholarships and Financial Aids

- The Government and the University offer various **scholarships** and **financial aids** depending on student's financial situation, or their outstanding performance in academic or other areas
- List of some scholarships and financial aids
 - » Admission Scholarships
 - » Scholarships for Overseas Studies
 - » Government or University Financial Aid
 - » Summer Subsistence and Travel Loan Scheme
 - » Student Residence Bursary Scheme
 - ...



Check out more details at

[the Office of Admissions and Financial Aid \(OAFA\)!](#)

**Q: What are the
career prospects of
CENG/CSCI graduates?**



Career Prospects

- Employers of our graduates include:
 - » Google
 - » Intel
 - » Microsoft
 - » IBM
 - » Apple
 - » Facebook
 - » Yahoo
 - » Deloitte
 - » Hong Kong Government
 - » Investment Banking Institutes
 -



Career Choices

- ✓ Entrepreneur
- ✓ Systems programmer
- ✓ Mobile app developer
- ✓ Database administrator
- ✓ Management/IT consultant
- ✓ Researcher
- ✓ Bioinformatics specialist
- ✓ System consultant
- ✓ Data analyst
- ✓ Web and content developer
- ✓ Network administrator
- ✓ Game designer/programmer
- ✓ Medical imaging specialist
- ✓ Software engineer
- ✓ System analyst
- ✓ Systems administrator
- ✓ Network engineer
- ✓ Data miner
- ✓ Systems integrator
- ✓ Business analyst



**Q: What is ELITE Stream?
How can I join it?**



Engineering Leadership, Innovation, Technology and Entrepreneurship Stream (ELITE Stream)

- Offered by the Faculty of Engineering to students with **excellent academic performance**.
- **Challenge** yourself with additional coursework, **invaluable extra-curricular activities**, exclusive stimulating and inspiring courses, **special exchange opportunities**, *etc.*!

Check out more details at
[the Faculty of Engineering!](#)



**Q: Can I transfer to AIST or
other majors in Year 2?**



If you look for AIST / other majors instead...

- You may submit application for **change of major** (to AIST or other majors), subject to prevailing regulations stipulated by RES and approval by relevant unit(s).
- If you are determined to go for AIST, you may choose **JS4468 / AISTN** as your first choice directly.



**Q: Can I declare
AIST / CSCI / CENG as
second major or minor?**



Declare Second Major / Minor

- You are **not allowed to declare AIST / CSCI / CENG as your second major or minor** if you are a CSE student.
- However, you are encouraged to broaden your horizons and declare second major / minor offered by other departments.



**Q: I am still struggling to
choose AIST / CSCI / CENG.
What can I do?**



If you are still struggling to choose...

- You can **go through our website and admission materials** for a better understanding before submission, and **write to us via email to ug-admiss@cse.cuhk.edu.hk** whenever you have any queries.
- You can **join our outreach activities** in the future and chat with our teachers and student ambassadors.
- You can also **subscribe our social media channels** to receive the latest updates from us! Stay tuned!



Contact Us



(852) 3943 4269



ug-admiss@cse.cuhk.edu.hk



www.cse.cuhk.edu.hk



See you in Fall 2023 !

