

---

# Department of Computer Science and Engineering

## Academic Counselling Session for New Students

---

August 23, 2022

By Prof. Leung Ho Fung



# Today's schedule

1. Graduation Requirements
2. Curriculum Structure
3. Declaration of Major
4. Diverse Learning Experience
5. Other Learning Options



# Graduation Requirements For 4-year Curriculum



# Graduation Requirements

Major  
Requirements  
(75 units)

University  
Core  
Requirements  
(39units)

Free  
Electives  
*(Remaining  
Units if any)*

**Min.  
123 Units  
for  
Graduation**

# University Core Requirements

University Core Courses	Units Requirements
English Language	8
Chinese Language	5
University General Foundation	6
University General Education	7 (At least 2 units in Area A, C, D)
College General Education	6
Understanding China (UGCP1001)	1
Hong Kong in the Wider Constitutional Order (UGCP1002)	1
Digital Literacy and Computational Thinking (ENGG1003 or ENGG1004)	3
Physical Education	2
<b>Total of units required</b>	<b>39</b>

# Major Requirements

Major Requirements	Computer Engineering	Computer Science
Faculty Package	9	
Foundation Courses	17	16
Major Required Courses	31	27
Research Components	6	
Stream Requirements	12	17
<b>Total of units required</b>	<b>75</b>	

# Curriculum Structure



# Curriculum – Major Requirements

4

Final Year  
Project

Major Electives

3

Major Core

Major  
Electives

2

Major  
Foundation

Major Core

1

Faculty  
Package

Faculty Foundation  
(Maths + Science)

75 units



# Curriculum – Faculty Package and Foundation

4

Final Year  
Project

Major Electives

3

Major Core

Major  
Electives

2

Major  
Foundation

Major Core

1

Faculty  
Package

Faculty Foundation  
(Maths + Science)

## Faculty Package and Foundation (15 units)

- » Programming (ENGG1110)
- » Linear Algebra (ENGG1120)
- » Multivariable Calculus (ENGG1130)
- » Calculus for Engineers (MATH1510)
- » Foundation Science

# Curriculum – Major Foundation *(for CE)*

4

Final Year  
Project

Major Electives

3

Major Core

Major  
Electives

2

Major  
Foundation

Major Core

1

Faculty  
Package

Faculty Foundation  
(Maths + Science)

## Major Foundation (11 units)

- » C++ (CSCI1120)
- » Complex Variables (ENGG2720)
- » Differential Equations (ENGG2740)
- » Probability (ENGG2760)
- » Statistics (ENGG2780)



ROLL	DICE CHART	PROBABILITY
2		1/36
3		2/36
4		3/36
5		4/36
6		5/36
7		6/36
8		5/36
9		4/36
10		3/36
11		2/36
12		1/36

# Curriculum – Major Core *(for CE)*

4

Final Year  
Project

Major Electives

3

Major Core

Major  
Electives

2

Major  
Foundation

Major Core

1

Faculty  
Package

Faculty Foundation  
(Maths + Science)

## Major Core (31 units)

- » Digital Logic Design Laboratory (CENG2010)
- » Fundamentals of Embedded Systems (CENG2030)
- » Embedded System Design (CENG2400)
- » Computer Organization and Design (CENG3420)



# Curriculum – Major Core (*for CE*)

4

Final Year  
Project

Major Electives

3

Major Core

Major  
Electives

2

Major  
Foundation

Major Core

1

Faculty  
Package

Faculty Foundation  
(Maths + Science)

## Major Core (31 units)

- » Data Structures (CSCI2100)
- » Software Engineering (CSCI3100)
- » Intro to Operating Systems (CSCI3150)
- » Discrete Mathematics and Algorithms (CSCI3190)
- » Computers and Society (CSCI3250)
- » Engineering Practicum (CSCI3251)

# Curriculum – Major Core (*for CE*)

4

Final Year  
Project

Major Electives

3

Major Core

Major  
Electives

2

Major  
Foundation

Major Core

1

Faculty  
Package

Faculty Foundation  
(Maths + Science)

## Major Core (31 units)

- » Fundamental of Electric Circuits (ELEG2202)
- » Digital Logic and Systems (ENGG2020)

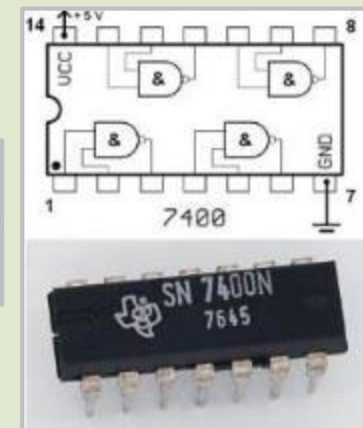
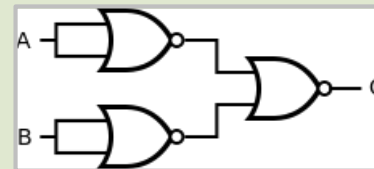

# Curriculum – Major Electives *(for CE)*

4

Final Year  
Project

Major Electives

3

Major Core

Major  
Electives

2

Major  
Foundation

Major Core

1

Faculty  
Package

Faculty Foundation  
(Maths + Science)

## Major Electives (12 units) Streams

1. Embedded Systems
2. VLSI Design and EDA

## Non-Stream

3. General Computer Engineering

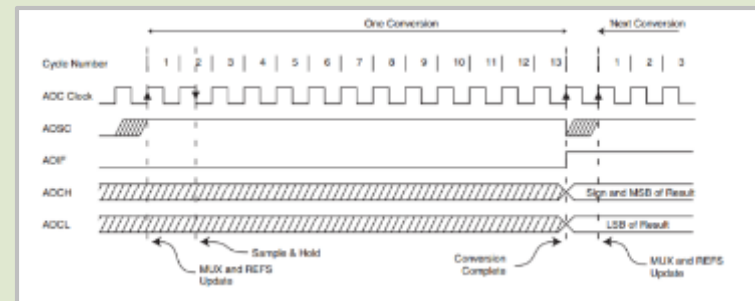

# Curriculum – Major Foundation *(for CS)*

4

Final Year  
Project

Major Electives

3

Major Core

Major  
Electives

2

Major  
Foundation

Major Core

1

Faculty  
Package

Faculty Foundation  
(Maths + Science)

## Major Foundation (10 units)

- » Java (CSCI1130)
- » Discrete Maths (ENGG2440)
- » Probability (ENGG2760)
- » Statistics (ENGG2780)

ROLL	DICE CHART	PROBABILITY
2		1/36
3		2/36
4		3/36
5		4/36
6		5/36
7		6/36
8		5/36
9		4/36
10		3/36
11		2/36
12		1/36



# Curriculum – Major Core (for CS)

4

Final Year  
Project

Major Electives

3

Major Core

Major  
Electives

2

Major  
Foundation

Major Core

1

Faculty  
Package

Faculty Foundation  
(Maths + Science)

## Major Core (27 units)

- » Computer Organization and Design (CENG3420)
- » Data Structure (CSCI2100)

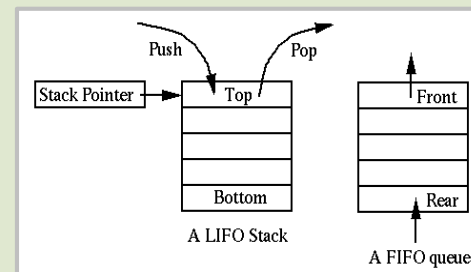
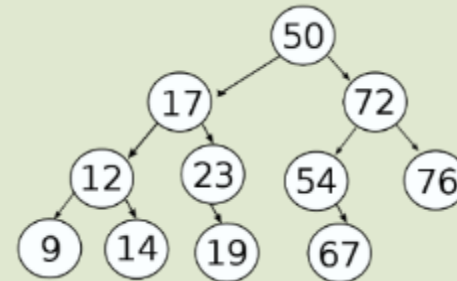



# Curriculum – Major Core *(for CS)*

4

Final Year  
Project

Major Electives

3

Major Core

Major  
Electives

2

Major  
Foundation

Major Core

1

Faculty  
Package

Faculty Foundation  
(Maths + Science)

## Major Core (27 units)

- » Software Engineering (CSCI3100)
- » Formal Languages and Automata Theory (CSCI3130)
- » Intro to Operating Systems (CSCI3150)
- » Design and Analysis of Algorithms (CSCI3160)
- » Principles of Programming Languages (CSCI3180)

# Curriculum – Major Core *(for CS)*

4

Final Year  
Project

Major Electives

3

Major Core

Major  
Electives

2

Major  
Foundation

Major Core

1

Faculty  
Package

Faculty Foundation  
(Maths + Science)

## Major Core (27 units)

- » Computers and Society (CSCI3250)
- » Engineering Practicum (CSCI3251)
- » Digital Logic and Systems (ENGG2020)

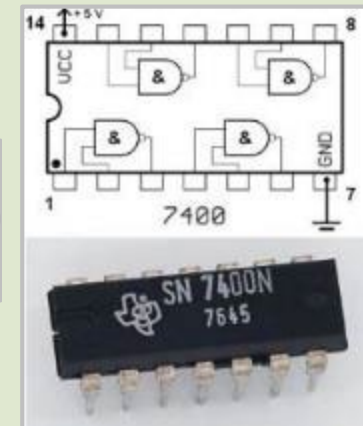
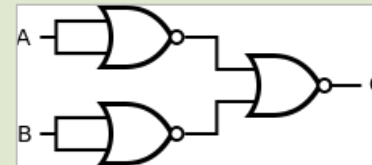

# Curriculum – Major Electives *(for CS)*

4

Final Year  
Project

Major Electives

3

Major Core

Major  
Electives

2

Major  
Foundation

Major Core

1

Faculty  
Package

Faculty Foundation  
(Maths + Science)

## Major Electives (17 units) Streams

1. Intelligence Science
2. Database and Information Systems
3. Rich Media
4. Distributed Systems, Networks and Security
5. Algorithms and Complexity
6. Data Analytics

## Non-Stream

7. General Computer Science

# Curriculum – Distinct Topics

- Computer-aided Design for Very Large Scale Integrated Circuits (CENG4120/CENG5030/CENG5270)

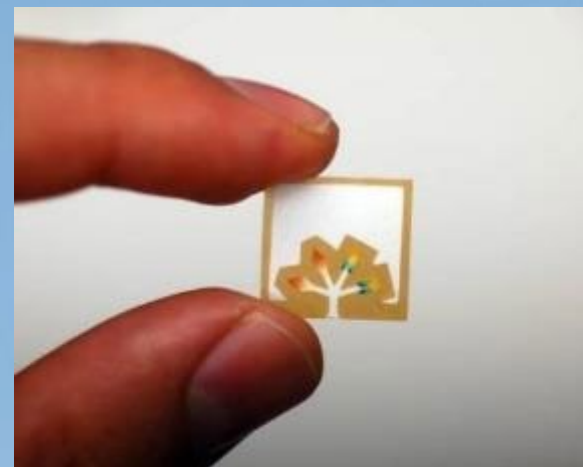
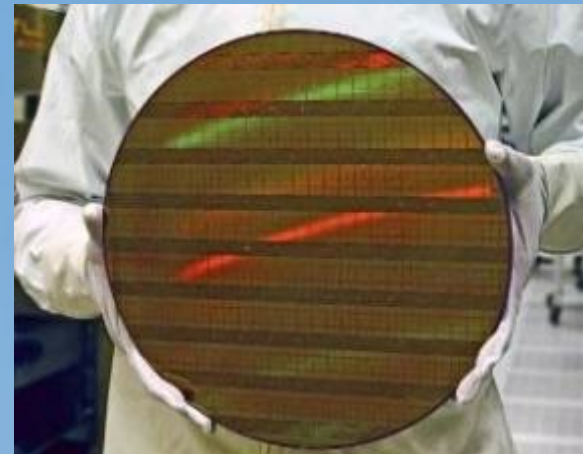
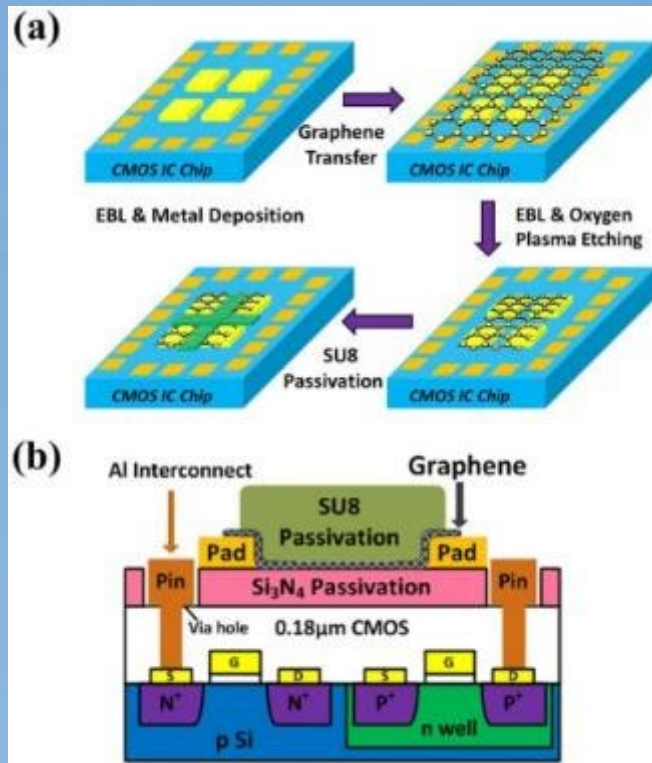

# Curriculum – Distinct Topics

- Embedded System Development and Applications (CENG4480)



# Curriculum – Distinct Topics

- Artificial Intelligence (CSCI3230/ESTR3108)
  - » Create computer software that are capable of intelligent behavior
    - ✓ Searching
    - ✓ Pattern recognition
    - ✓ Genetics algorithms
    - ✓ Artificial neural networks
    - ✓ Deep learning

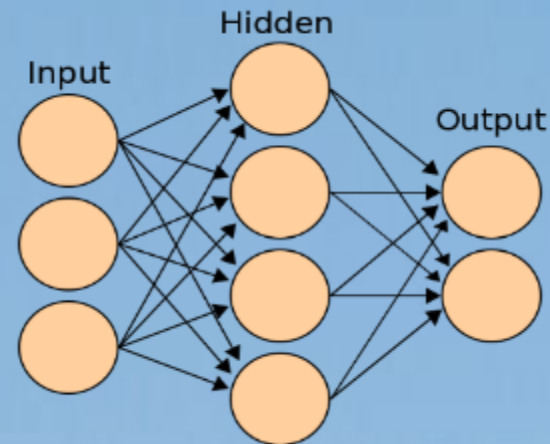
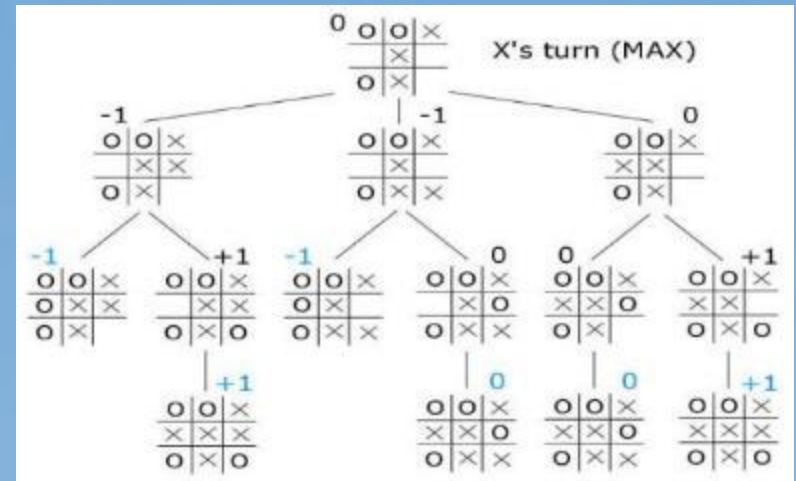

# Curriculum – Distinct Topics

- Computer Graphics and Multi-media (CSCI3260/CSCI3280/CSCI3290)

- » Use graphics cards to create photorealistic images and movies

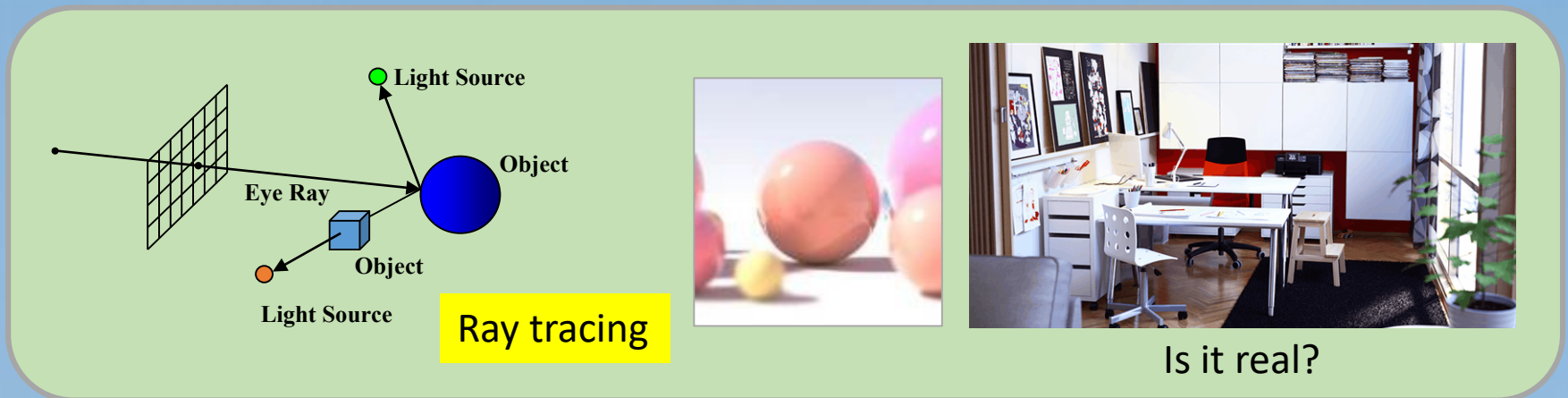
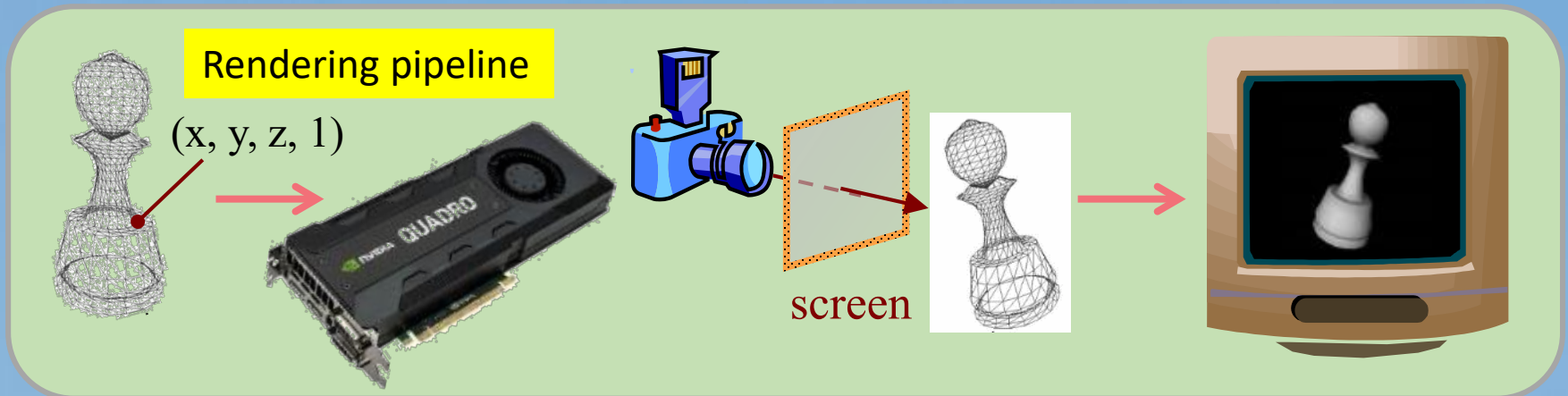

# Curriculum – Distinct Topics

- Computer Graphics and Multi-media (CSCI3260/CSCI3280/CSCI3290)

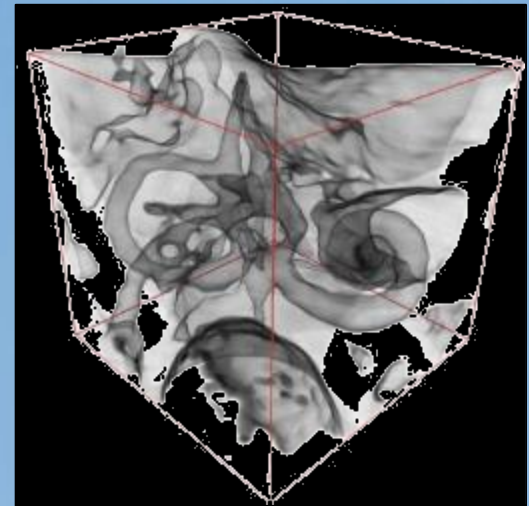
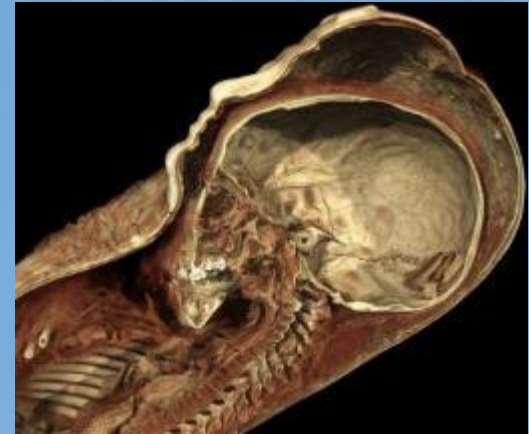
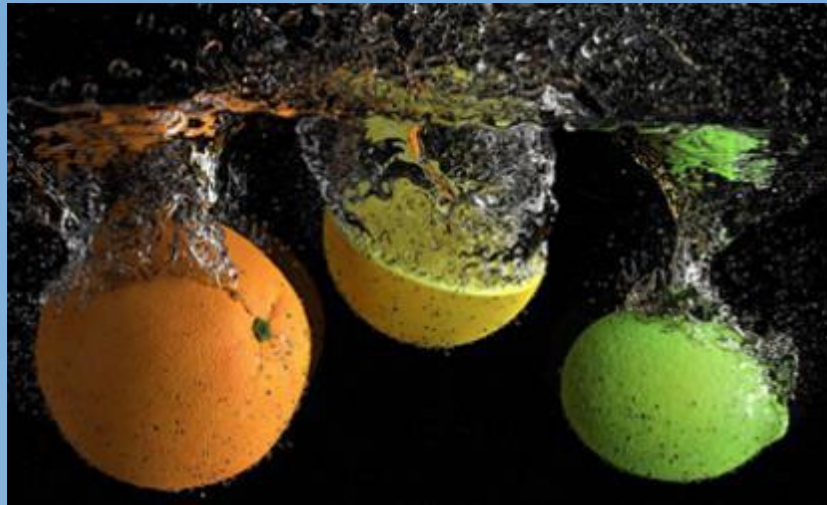

Film & visual effects  
& data visualization



# Curriculum – Distinct Topics

- Computer Game Software (CSCI4120)

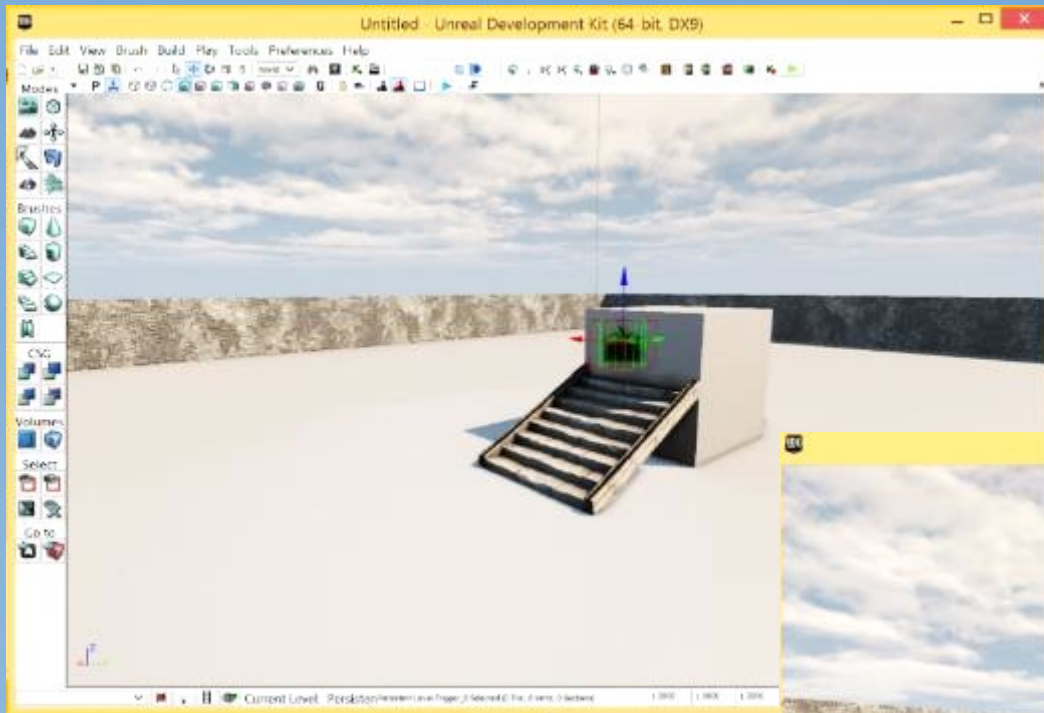

Learn how to  
develop a game



# Curriculum – Distinct Topics

- Computer Game Software (CSCI4120)



Students' course projects



# Curriculum – Distinct Topics

- Algorithms for Bioinformatics (CSCI3220)
  - » Use computer to model and interpret biological data
  - » DNA mutation  $\leftrightarrow$  diseases

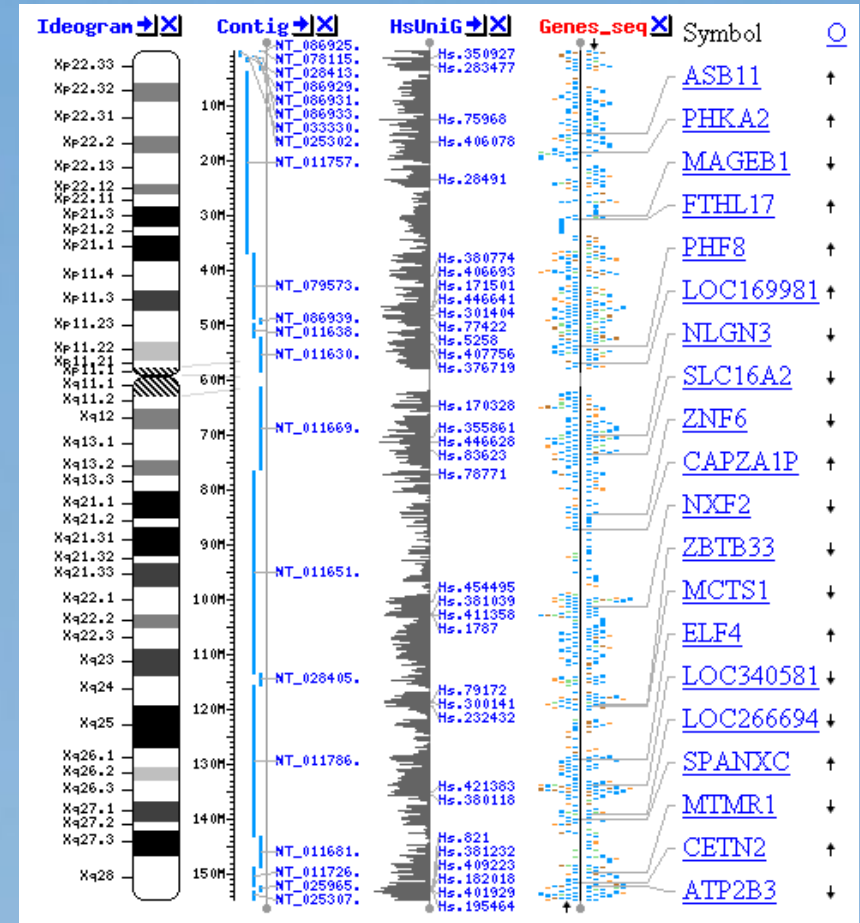
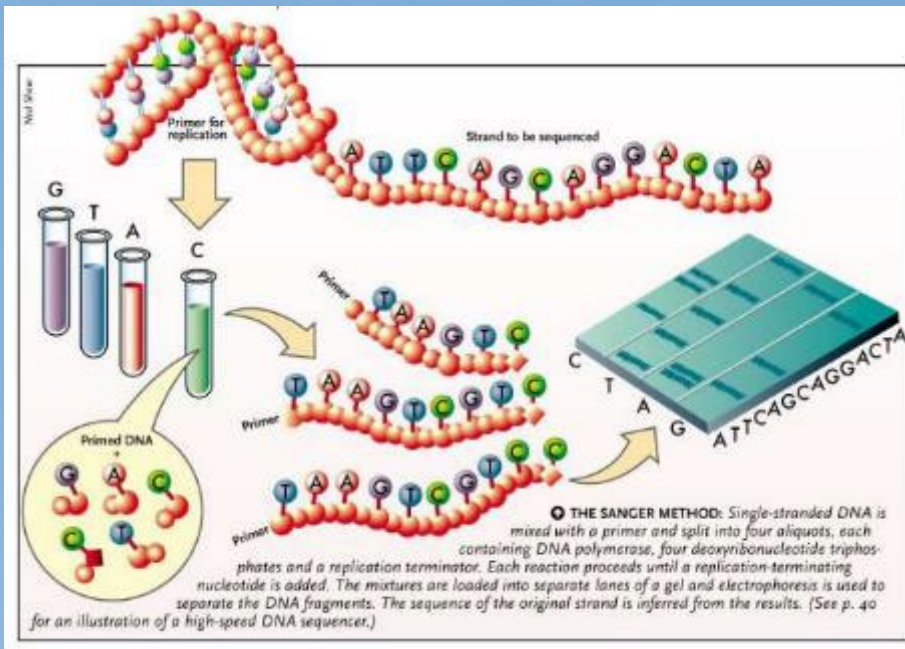

# Curriculum – Distinct Topics

- Big Data Analytics and Machine Learning (CSCI3170/CSCI3320/CSCI4180/CSCI5510)

ATCGAATTCCATAATC  
ATTATCGAACTTACGA  
AATTTACAATCAATCG

Data



Knowledge



ATCGAATTCCATAATC  
ATTATCGAACTTACGA  
AATTTACAATCAATCG

Patterns



Information



Fast and  
Efficient

# Curriculum – Distinct Topics

- Many other practical and interesting courses:
  - » Algorithms
  - » Cloud Computing
  - » Computational Finance
  - » Computer and Network Security
  - » Databases
  - » Energy Efficient Computing
  - » Networks
  - » Operating Systems
  - » Rapid Prototyping of Digital Systems
  - » Smart Hardware Design
  - » .....



# Declaration of Major



# Declaration of Major

- Major:
  - Computer Science
  - Computer Engineering
- Declaration procedure:
  - The department will send an email to inform the student about the declaration procedure and period after term 1.
- Declaration Period: tentative in term 2
- Criteria: CGPA

# Academic Advising

Every student is assigned an academic advisor who meets with the students at least once a year for purposes of general supervision such as course selection, guided study, adaptation to University learning modes and disciplinary fundamentals, etc. Students with academic problems or on academic probation / extended probation are required to have a monthly meeting with the academic advisor.



# Diverse Learning Experiments



# Recent Competitions and Achievements

## International Collegiate Programming Contest (ICPC)

*(formerly named as ACM Programming Competition)*

**2021: ranked 16<sup>th</sup>  
(World Finals)**

2019: ranked 12<sup>th</sup>

2012: ranked 8<sup>th</sup>

2011: ranked 13<sup>th</sup>

2001: ranked 8<sup>th</sup>

## PwC's HackaDay

**2021: champion**

**2019: 2nd Place**

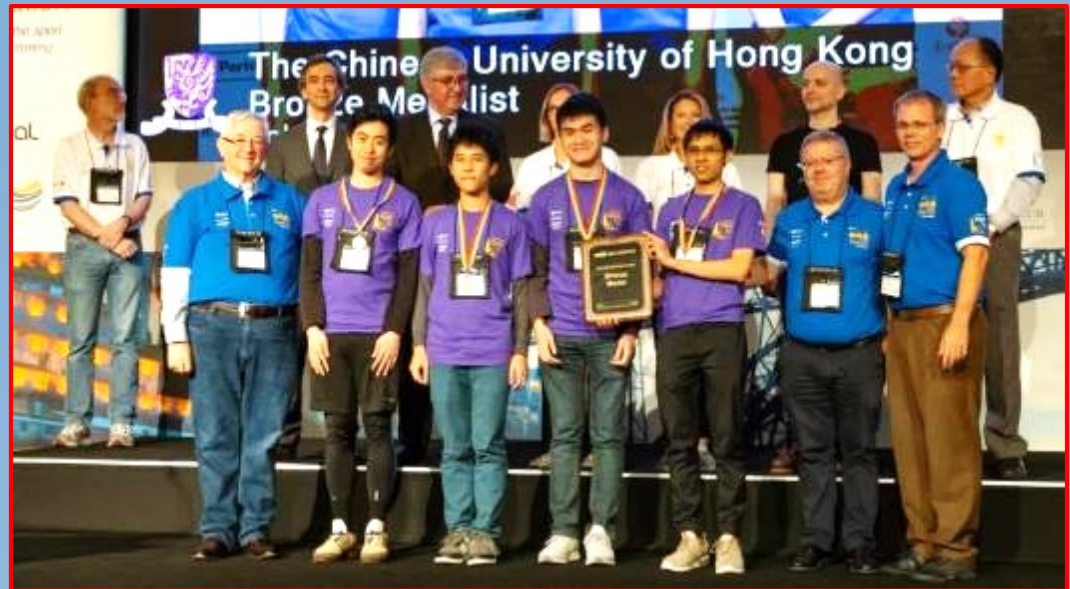

# Recent Competitions and Achievements

## Robonco

**2022: champion**

**2021: champion**



# Industrial Visits

- Visit to companies to learn latest development in industry



# Work-Study Scheme

2 or 3 years study + 1 year work-study

Google

 Microsoft



FUJITSU

 HSBC

 恒生銀行 HANG SENG BANK

 新鴻基地產  
Sun Hung Kai Properties

ASM  Pacific Technology

  
香港科技園



# Exchange Opportunities

*e.g.*

- Macquarie University, Australia
- University of Toronto, Canada
- University of Waterloo, Canada
- Shanghai Jiao Tong University, China
- Soka University, Japan
- National University of Singapore, Singapore
- University of Sheffield, UK
- University of California, Davis, USA
- University of Massachusetts Amherst, USA

# Other learning activities

- Double degree option with IBBA
- Double majors
- Minor programme(s)

# Important Reminders (1/3)

- Treasure your opportunity in University study.
- Time management: study, activities, part-time job, etc.
- Study scheme updated every year, e.g., new courses.  
You **SHOULD** follow the study scheme in your entry year, i.e., **2022 entry**, and keep following it.
- Course prerequisite!
- Declaration stream: you could declare the stream in Sep of your final year.



# Important Reminders (2/3)

- Make use of our intranet for UG students, since the department staff will make announcements by emails and put announcements in our intranet.

<https://i.cse.cuhk.edu.hk/undergraduate/>

- Email forwarding to/from your CUHK email accounts.
- Our CSE Tech Team will provide each of you a CSE account for login to our system and PCs in labs.

# Useful links

- Student Handbook

<https://www.aqs.cuhk.edu.hk/undergraduate-student-handbook/#undergraduate-student-handbook>

- Registration and Examinations Section

<http://www.res.cuhk.edu.hk/>

- Office of Academic Links (OAL)

<https://www.oal.cuhk.edu.hk/>

- Office of Student Affairs (OSA)

<http://www.osa.cuhk.edu.hk/>

- Financing Your Studies by the Office of Admissions and Financial Aid

<http://admission.cuhk.edu.hk/finance.html>

- ITSC

<https://www.itsc.cuhk.edu.hk/>

- Library

<https://www.lib.cuhk.edu.hk/>

# Important Reminders (3/3)

- Our department is responsible only for AIST/CENG/CSCI course, if you have questions on other courses, please refer to the department that offers that course.



[dept@cse.cuhk.edu.hk](mailto:dept@cse.cuhk.edu.hk)



<http://www.cse.cuhk.edu.hk>



# **Last Session: Questions & Answers**

# Q1: Can I “NOT follow” the recommended study pattern?

As almost all courses are **pre-assigned**, you need to receive the department’s consent to drop the required courses.

We “**DO NOT RECOMMEND**” you not to follow the study pattern, because you may face **time conflict** in the major required courses during the upper years.

## Q2: Can I take more than 18 units per semester?

Yes, you may apply for **credit overload** in a semester, but we **recommend not to rush to finish your study.**

Note, some students could take 19 units in year 1, because almost all courses are pre-assigned.

The pre-assigned units depend on your affiliated college; some colleges will pre-assign College General Education (GE) for students, while some will not.

# Q3: Can I declare more than one stream?

No

## CE

### Major Electives (12 units)

#### Streams

1. Embedded Systems
2. VLSI Design and EDA

#### Non-Stream

3. General Computer Engineering

## CS

### Major Electives (17 units)

#### Streams

1. Intelligence Science
2. Database and Information Systems
3. Rich Media
4. Distributed Systems, Networks and Security
5. Algorithms and Complexity
6. Data Analytics

#### Non-Stream

7. General Computer Science

## Q4: Can I use AD/HD course to apply for course exemption?

Yes, you may apply, but we will consider case by case.

Upon approval, you can exempt the applied course only, but NOT the units.

Also, you are required to take other major courses to fulfill the units requirements.



Q5: If I go for exchange, can I apply for credit transfer?

Yes, you may apply for that, but PLEASE apply the credit transfer **IN ADVANCE** by providing the course details to our CSE department before enrolling the courses in the exchange university.

# Thank you !

