

1. Definition of surjectivity.

Let A, B be sets, and $f : A \longrightarrow B$ be a function from A to B .

f is said to be **surjective** if the statement (S) holds:

(S) : For any $y \in B$, there exists some $x \in A$ such that $y = f(x)$.

In the symbols of logic, (S) is:

$$(\forall y \in B)[(\exists x \in A)(y = f(x))].$$

So for each $y \in B$, (S) gives an existence statement.

2. Pictorial visualizations of surjective functions.

(a) ‘Blobs-and-arrows diagram’.

f is surjective exactly when:

- every element of B is ‘pointed’ at by at least one element of A .

(b) ‘Coordinate plane diagram’.

f is surjective exactly when:

- for each $b \in B$, the equation $b = f(u)$ with ‘unknown’ u has at least one solution in A .

3. Example of a surjective function and its pictorial visualizations.

Let $A = \{m, n, p, q, r, s, t, \dots\}$, $B = \{c, d, e, g, h, \dots\}$, and $f : A \rightarrow B$ be the surjective function defined by

$$f(m) = c, f(n) = d, f(p) = f(q) = e, f(r) = g, f(s) = f(t) = h, \dots .$$

(a) ‘Blobs-and-arrows diagram’

Every element of B is ‘pointed’ at by at least one element of A .

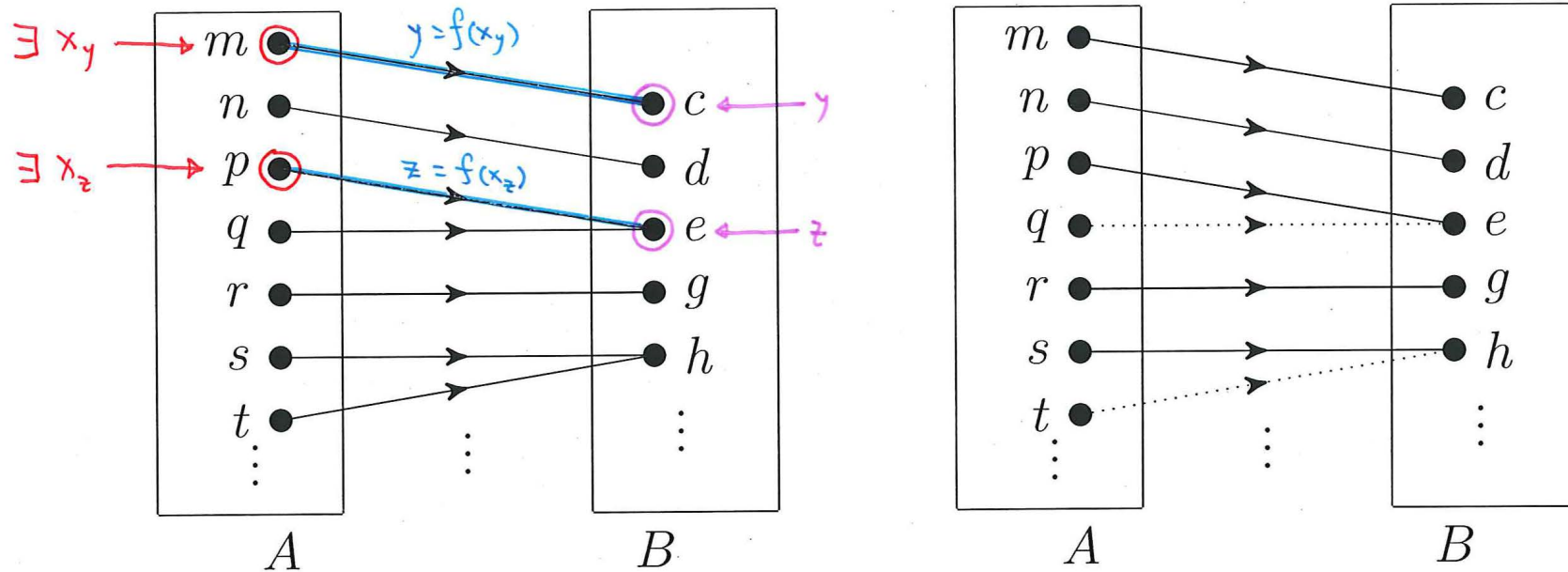

(b) 'Coordinate plane diagram'.

For each $b \in B$, the equation $b = f(u)$ with 'unknown' u has at least one solution in A .

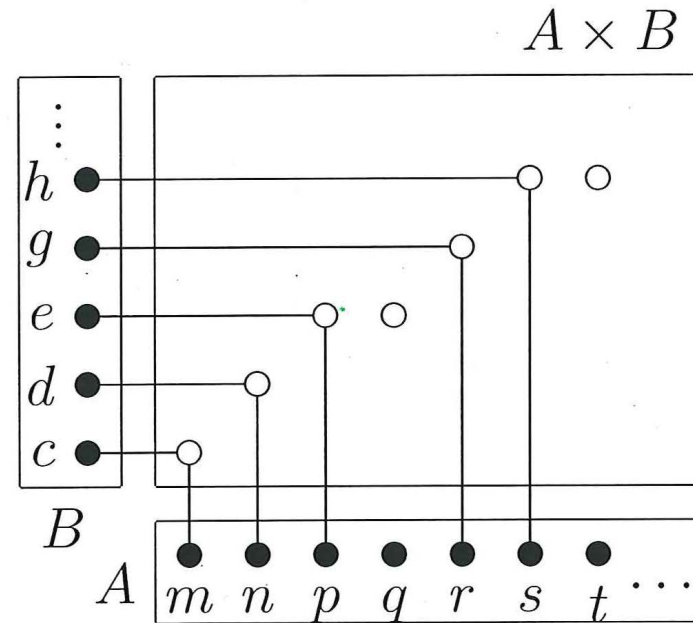
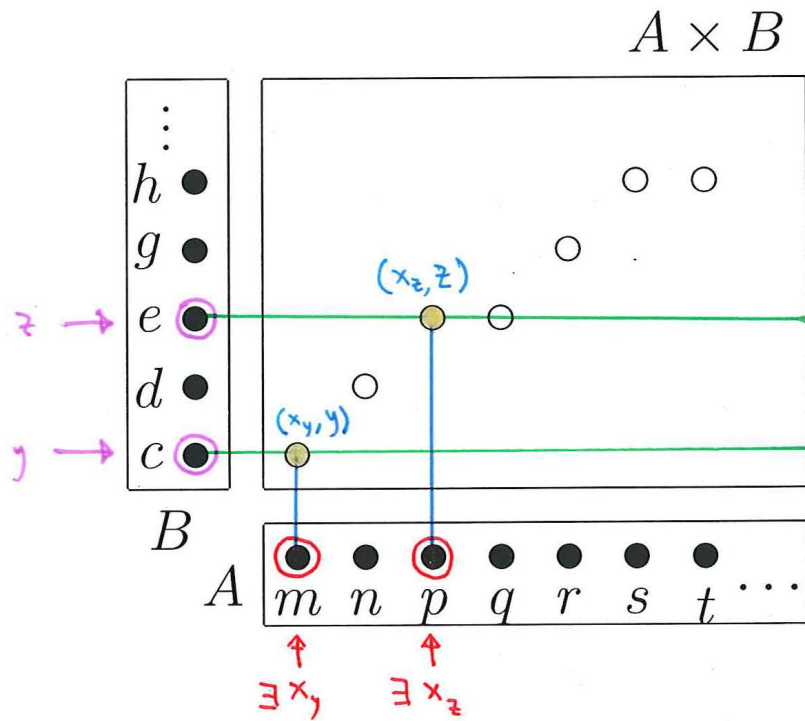

'Horizontal line "Constant c "'
cuts the graph of f somewhere,
namely, (m, c) .

\Leftrightarrow The equation $c = f(u)$ with unknown u in A
has some solution, namely, ' $u = m$ '.

There is the same phenomenon for every element of B , not just c .

4. How to check that a given function $f : A \longrightarrow B$ is surjective?

What to check?

(S): For any $y \in B$, there exists some $x \in A$ such that $y = f(x)$.

Procedure:

- (1) Pick any $y \in B$. (From this moment on this y is fixed.)
- (2a) Name an appropriate x_y which you believe will satisfy both $x_y \in A$ and $y = f(x_y)$, when it is immediately clear which x_y is to be named.
- (2b) When it is not immediately clear which x_y is to be named, do some roughwork:
 - * With y fixed, solve the equation $y = f(u)$ with ‘unknown’ u in A .
One such solution is an appropriate candidate x_y to be named.
- (3) Verify that the x_y just named indeed satisfy $x_y \in A$ and $y = f(x_y)$.

5. Negation of surjectivity.

Let A, B be sets, and $f : A \longrightarrow B$ be a function. $f : A \longrightarrow B$ is not surjective iff the statement $\sim(S)$ holds:

$\sim(S)$: There exists some $y_0 \in B$ such that for any $x \in A$, $y_0 \neq f(x)$.

In the symbols of logic, $\sim(S)$ is:

$$(\exists y_0 \in B)[(\forall x \in A)(y_0 \neq f(x))].$$

6. Pictorial visualizations of non-surjective functions.

(a) ‘Blobs-and-arrows diagram’.

f is not surjective exactly when:

- some element of B is ‘pointed’ at by no element of A .

(b) ‘Coordinate plane diagram’.

f is not surjective exactly when:

- there is some element b_0 of B for which the equation $b_0 = f(u)$ with ‘unknown’ u has no solution in A .

7. Example of a non-surjective functions and its pictorial visualizations.

Let $A = \{m, n, p, q, r, s, t, \dots\}$, $B = \{c, d, e, g, h, \dots\}$, and $f : A \rightarrow B$ be the non-surjective function defined by

$$f(m) = c, f(n) = f(p) = f(q) = d, f(r) = g, f(s) = f(t) = h, \dots .$$

(a) 'Blobs-and-arrows diagram'

Some element of B is 'pointed' at by no element of A .

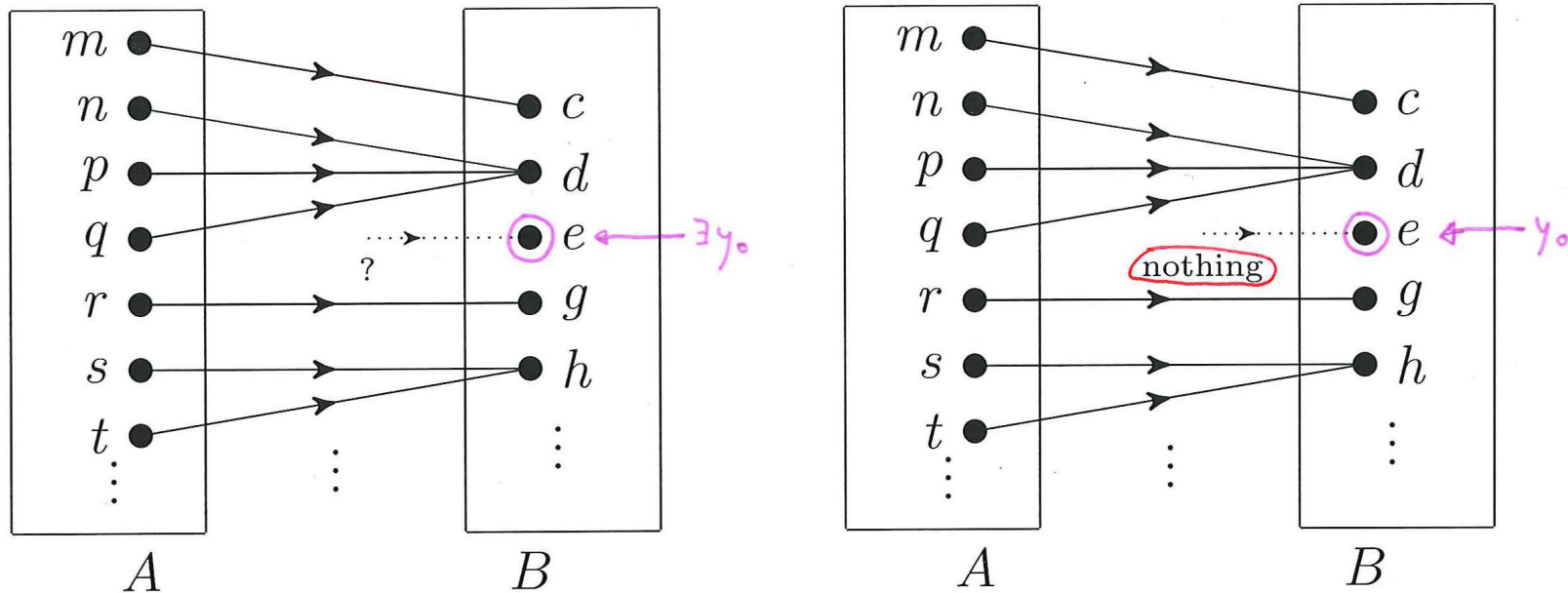

(b) 'Coordinate plane diagram'.

There is some element b_0 of B for which the equation $b_0 = f(u)$ with 'unknown' u has no solution in A .

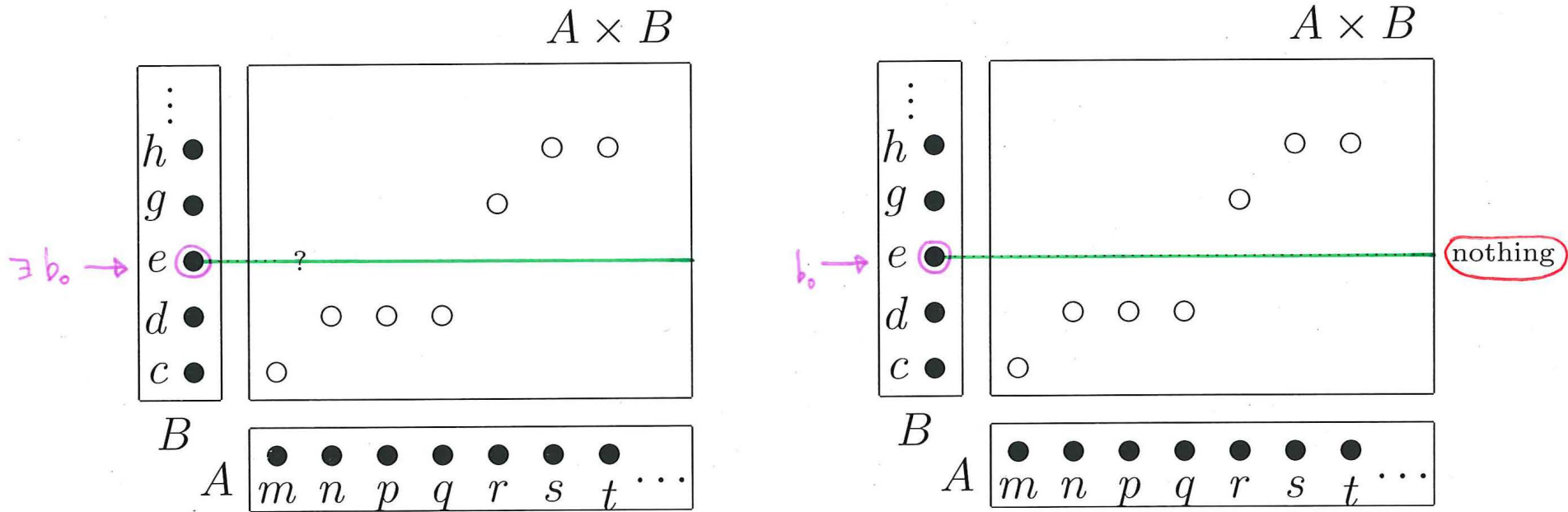

'Horizontal line "Constant e "'
cuts the graph of f nowhere.

\Leftrightarrow The equation $e=f(u)$ with unknown u in A
has no solution.

8. How to check that a given function $f : A \longrightarrow B$ is not surjective?

What to check?

$\sim(S)$: *There exists some $y_0 \in B$ such that for any $x \in A$, $y_0 \neq f(x)$.*

Procedure:

- (1a) Name appropriate ‘concrete’ $y_0 \in B$ which you believe will satisfy $y_0 \neq f(x)$ for any $x \in A$, when it is immediately clear which y_0 to be named.
- (1b) When it is not immediately clear which y_0 is to be named, do some roughwork:
 - (1b.i) First look for a necessary condition in terms of the ‘value’ of b for the equation $b = f(u)$ with ‘unknown’ u to have a solution, by asking this question:

‘What can be said of b if $b = f(u)$ has a solution?’
 - (1b.ii) Look for an appropriate y_0 which has to be something failing to satisfy this necessary condition.
- (2) Then go to (†) or (‡):
 - (†) Verify that for any $x \in A$, $f(x) \neq y_0$.
 - (‡) Obtain a contradiction under the assumption ‘there existed some $x_0 \in A$ such that $f(x_0) = y_0$ ’.

9. Definition of injectivity.

Let A, B be sets, and $f : A \longrightarrow B$ be a function from A to B .

f is said to be **injective** if the statement (I) holds:

(I) : For any $x, w \in A$, if $f(x) = f(w)$ then $x = w$.

Various re-formulation of (I) :

(I') : For any $x, w \in A$, if $x \neq w$ then $f(x) \neq f(w)$.

(I'') : For any $y \in B$, for any $x, w \in A$, if $(y = f(x) \text{ and } y = f(w))$ then $x = w$.

In the symbols of logic, (I) , (I') , (I'') are:

(I) : $(\forall x \in A)(\forall w \in A)[(f(x) = f(w)) \rightarrow (w = x)]$.

(I') : $(\forall x \in A)(\forall w \in A)[(x \neq w) \rightarrow (f(x) \neq f(w))]$.

(I'') : $(\forall y \in B)(\forall x \in A)(\forall w \in A)[[(y = f(x)) \wedge (y = f(w))] \rightarrow (x = w)]$.

So for each $y \in B$, (I'') gives a uniqueness statement.

10. Negation of injectivity.

Let A, B be sets, and $f : A \longrightarrow B$ be a function.

f is not injective iff the statement $\sim(I)$ holds:

$\sim(I)$: There exist some $x_0, w_0 \in A$ such that $f(x_0) = f(w_0)$ and $x_0 \neq w_0$.

Re-formulation of $\sim(I)$ as $\sim(I'')$:

$\sim(I'')$: There exist some $y_0 \in B, x_0, w_0 \in A$ such that $(y_0 = f(x_0))$ and $y_0 = f(w_0)$ and $x_0 \neq w_0$.

$\sim(I), \sim(I')$ are exactly the same as each other. (Why?)

In the symbols of logic, $\sim(I), \sim(I'), \sim(I'')$ are:

$\sim(I), \sim(I') :$ $(\exists x_0 \in A)(\exists w_0 \in A)[(f(x_0) = f(w_0)) \wedge (x_0 \neq w_0)].$

$\sim(I'') :$ $(\exists y_0 \in B)(\exists x_0 \in A)(\exists w_0 \in A)[(y_0 = f(x_0)) \wedge (y_0 = f(w_0)) \wedge (x_0 \neq w_0)].$

11. Pictorial visualizations of non-injective functions.

(a) ‘Blobs-and-arrows diagram’.

f is not injective exactly when:

- some element of B is ‘pointed’ at by two or more elements of A .

(b) ‘Coordinate plane diagram’.

f is not injective exactly when:

- there is some element b_0 of B for which the equation $b_0 = f(u)$ with ‘unknown’ u has two or more solutions in A .

12. Example of a non-injective function and its pictorial visualizations.

Let $A = \{m, n, p, q, r, s, t, \dots\}$, $B = \{c, d, e, g, h, \dots\}$, and $f : A \rightarrow B$ be the non-injective function defined by

$$f(m) = c, f(n) = f(p) = f(q) = d, f(r) = g, f(s) = f(t) = h, \dots .$$

(a) ‘Blobs-and-arrows diagram’

Some element of B is ‘pointed’ at by two or more elements of A .

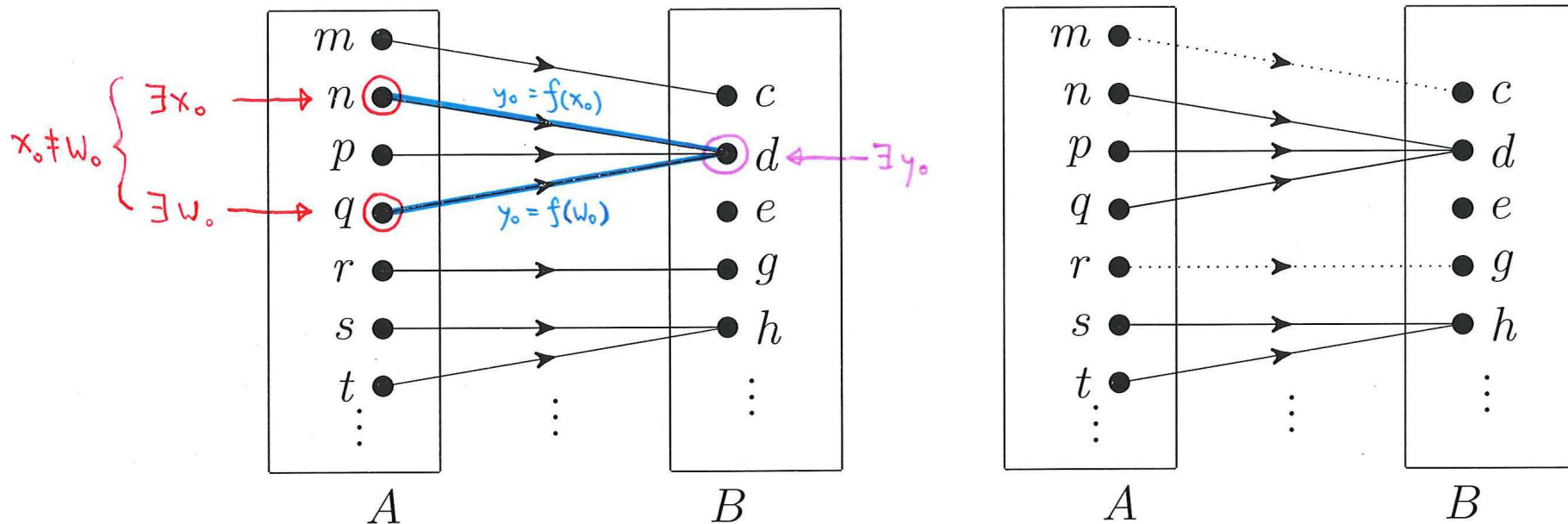

(b) 'Coordinate plane diagram'

There is some element b_0 of B for which the equation $b_0 = f(u)$ with 'unknown' u has two or more solutions in A .

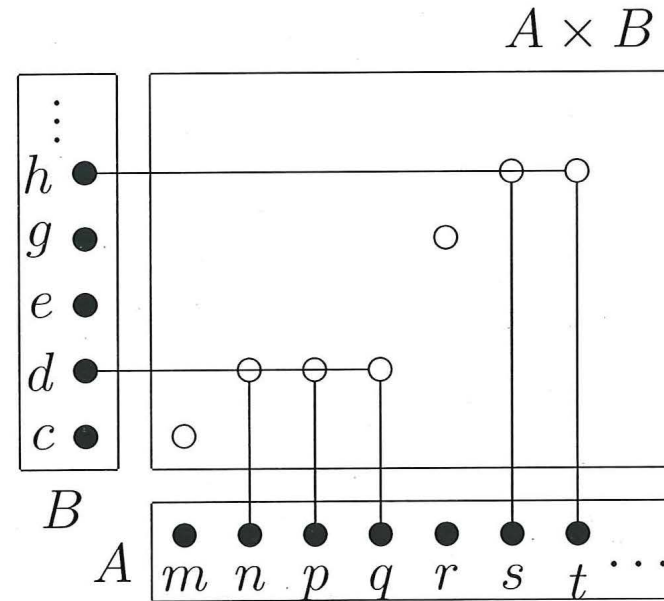
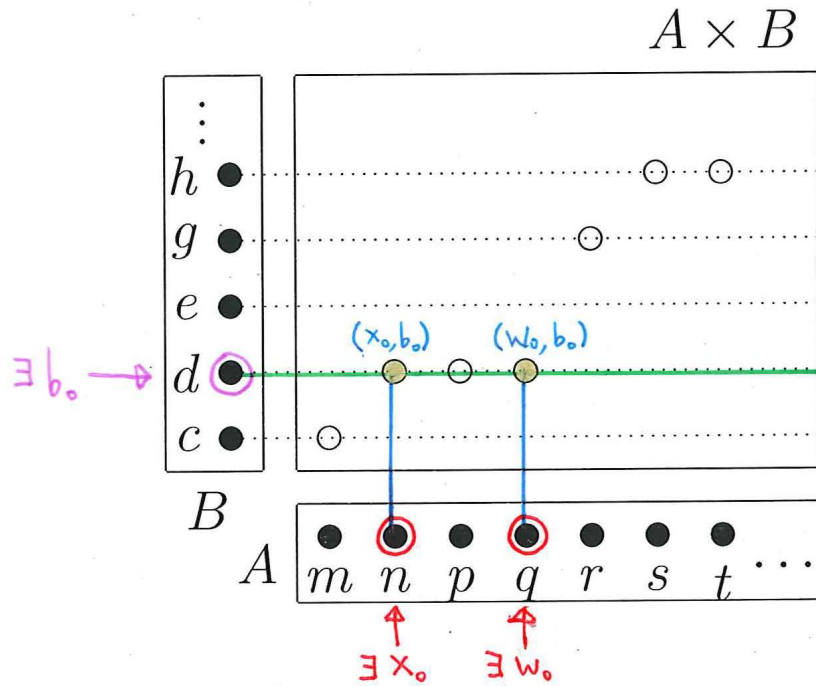

'Horizontal line "Constant d "'

cuts the graph of f at two distinct points, namely $(n, d), (q, d)$.

\Leftrightarrow The equation $d = f(u)$ with unknown u in A has two distinct solutions, namely ' $u=n$ ', ' $u=q$ '.

13. Pictorial visualizations of injective functions.

(a) ‘Blobs-and-arrows diagram’.

f is injective exactly when:

- every element of B is ‘pointed’ at by at most one element of A .

(b) ‘Coordinate plane diagram’.

f is injective exactly when:

- for each $b \in B$, the equation $b = f(u)$ with ‘unknown’ u has at most one solution in A .

14. **Example of an injective function and its pictorial visualization.**

Let $A = \{p, q, r, s, t, \dots\}$, $B = \{c, d, e, g, h, k, \ell, \dots\}$, and $f : A \longrightarrow B$ be the injective function defined by

$$f(p) = c, f(q) = d, f(r) = g, f(s) = k, f(t) = \ell, \dots .$$

(a) *Blobs-and-arrows diagram?*

Every element of B is ‘pointed’ at by at most one element of A .

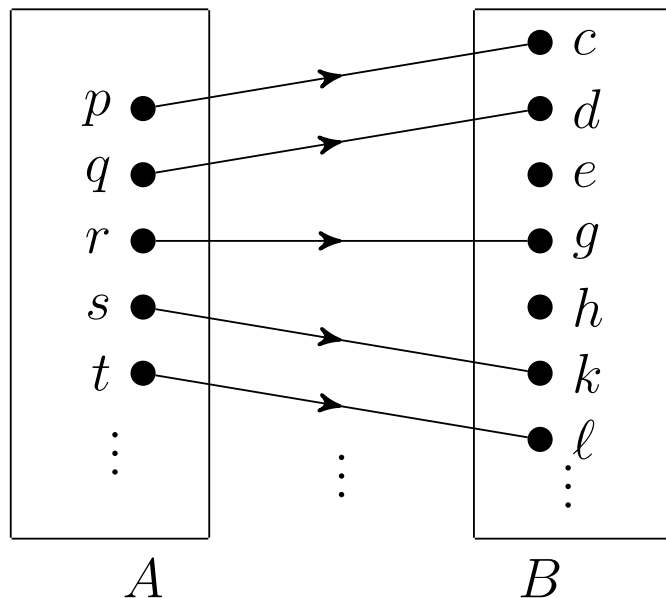

(b) ‘Coordinate plane diagram?’

For each $b \in B$, the equation $b = f(u)$ with ‘unknown’ u has at most one solution in A .

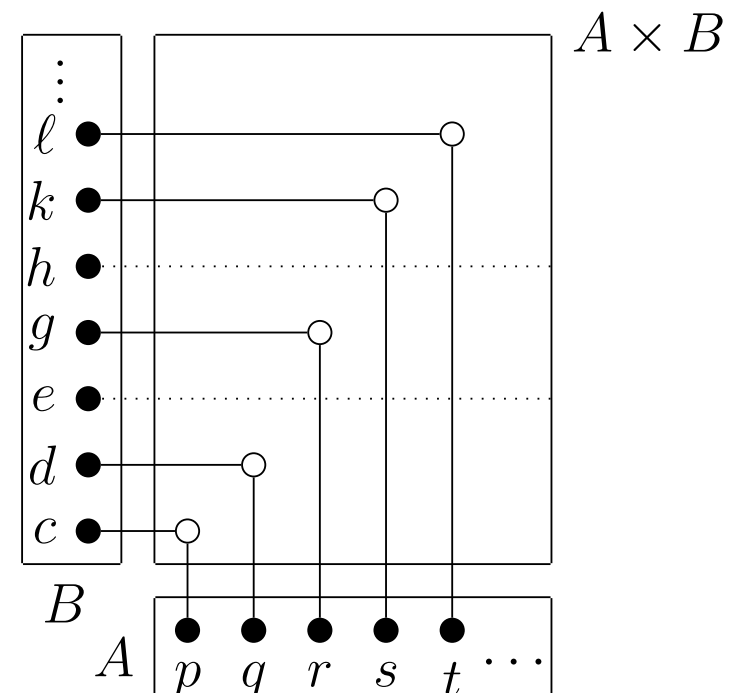

15. How to check that a given function $f : A \longrightarrow B$ is injective?

What to check?

(I): For any $x, w \in A$, if $f(x) = f(w)$ then $x = w$.

Procedure:

(1) Pick any $x, w \in A$. (From this moment on, x, w are fixed.)

(2) Suppose $f(x) = f(w)$. Then verify that $x = w$.

16. How to check that a given function $f : A \longrightarrow B$ is not injective?

What to check?

$\sim(I)$: There exists some $x_0, w_0 \in A$ such that $f(x_0) = f(w_0)$ and $x_0 \neq w_0$.

Procedure:

(1a) Name appropriate ‘concrete’ distinct $x_0, w_0 \in A$ which you believe will satisfy $f(x_0) = f(w_0)$, when it is immediately clear which x_0, w_0 are to be named.

(1b) When it is not immediately clear which distinct x_0, w_0 are to be named, do some roughwork:

* Look for an appropriate $b_0 \in B$ for which the equation $b_0 = f(u)$ with ‘unknown’ u has at least two solutions in A . Two such solutions are to be named as x_0, w_0 .

(2) Verify that $f(x_0) = f(w_0)$ indeed.