

# HKIX Development and HKIX-R&E Updates at APAN 50

*Kenneth Lo*

*HKIX Team*

[www.hkix.net](http://www.hkix.net)

*03-07 Aug 2020, Hong Kong*

# What is HKIX?

- Established in Apr 1995, [Hong Kong Internet eXchange \(HKIX\)](#) is the main layer-2 Internet eXchange Point (IXP) in Hong Kong where various autonomous systems interconnect with one another and exchange traffic
- HKIX is now owned and operated by the Hong Kong Internet eXchange Limited (a wholly-owned subsidiary of The Chinese University of Hong Kong Foundation Limited) in collaboration with [Information Technology Services Centre](#) of [The Chinese University of Hong Kong](#)
- HKIX serves both **commercial networks** and **Research and Education (R&E) networks**
- The original goal is to keep intra-Hong Kong traffic within Hong Kong

# HKIX Today

- Supports both MLPA (Multilateral Peering) and BLPA (Bilateral Peering) over layer 2
- Supports IPv4/IPv6 dual-stack
- More and more non-HK participants
- 330+ different networks (autonomous systems) connected
- 560+ physical connections in total
  - 75 **100GE**, 340+ **10GE** & 150+ **GE**
- 1.75+Tbps (5-min) total traffic at peak
- Annual Traffic Growth **~30%**

# Current HKIX Traffic Daily Graph (5-min average)

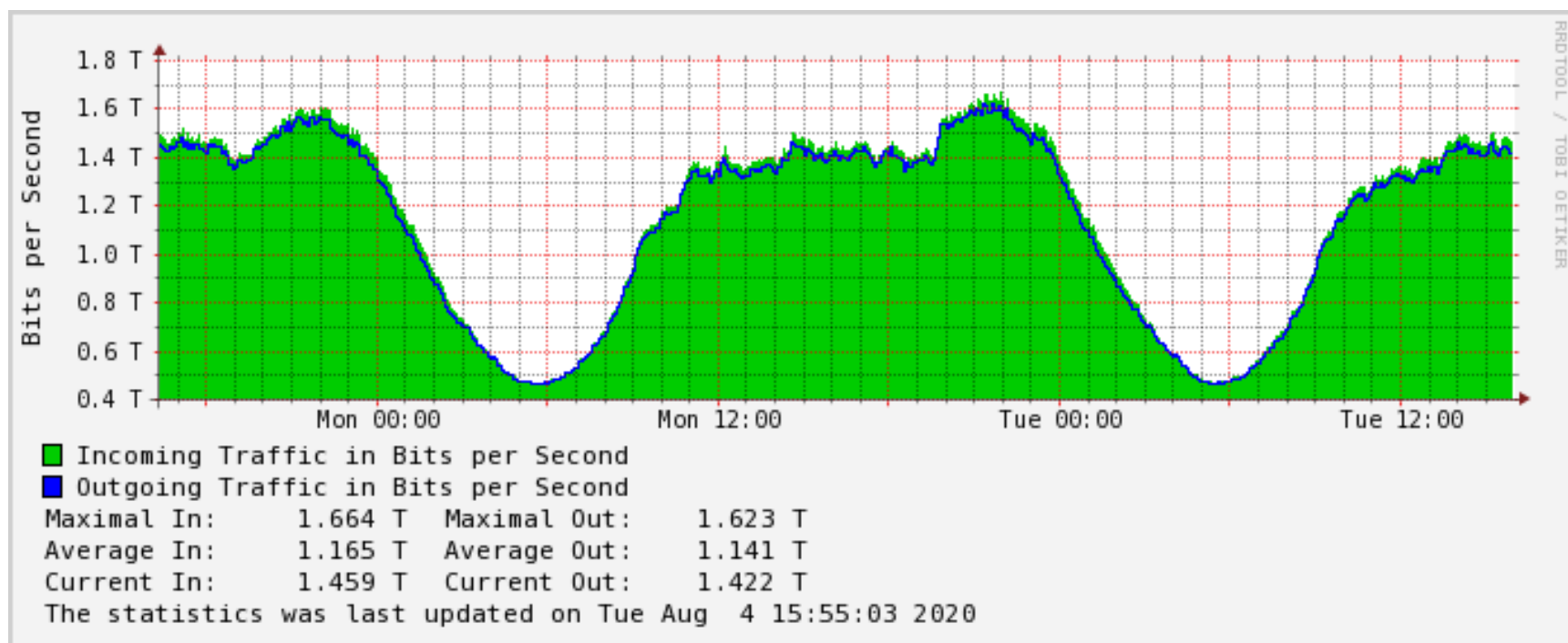

# Current HKIX Traffic

## Yearly Graph (1-day average)

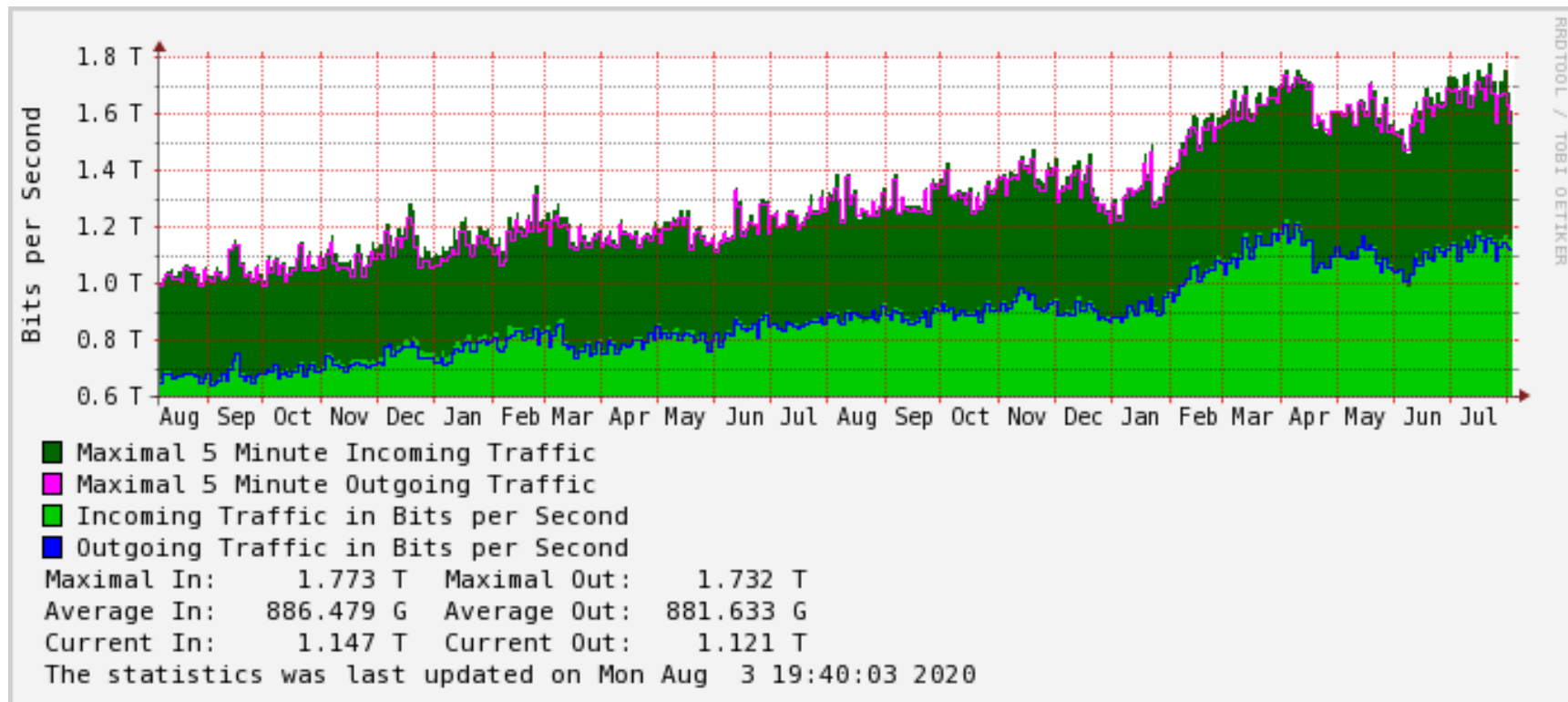

# New HKIX Dual-Core Two-Tier Spine-and-Leaf Architecture For 2014 and Beyond



HKIX1 Core Site @CUHK -----(<2km)----- HKIX1b Core Site @CUHK

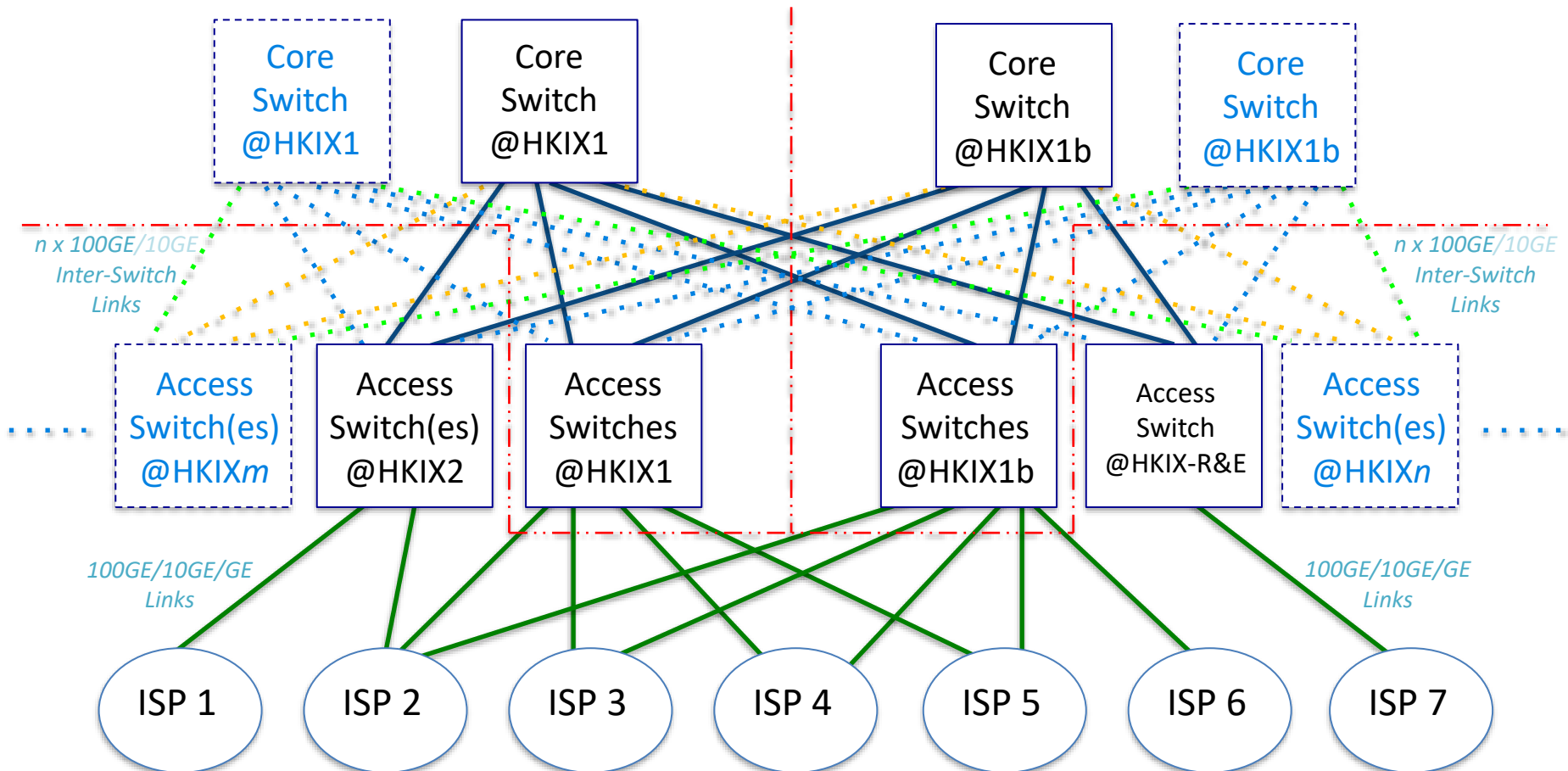

## HKIX Network Diagram (Jul 2020)

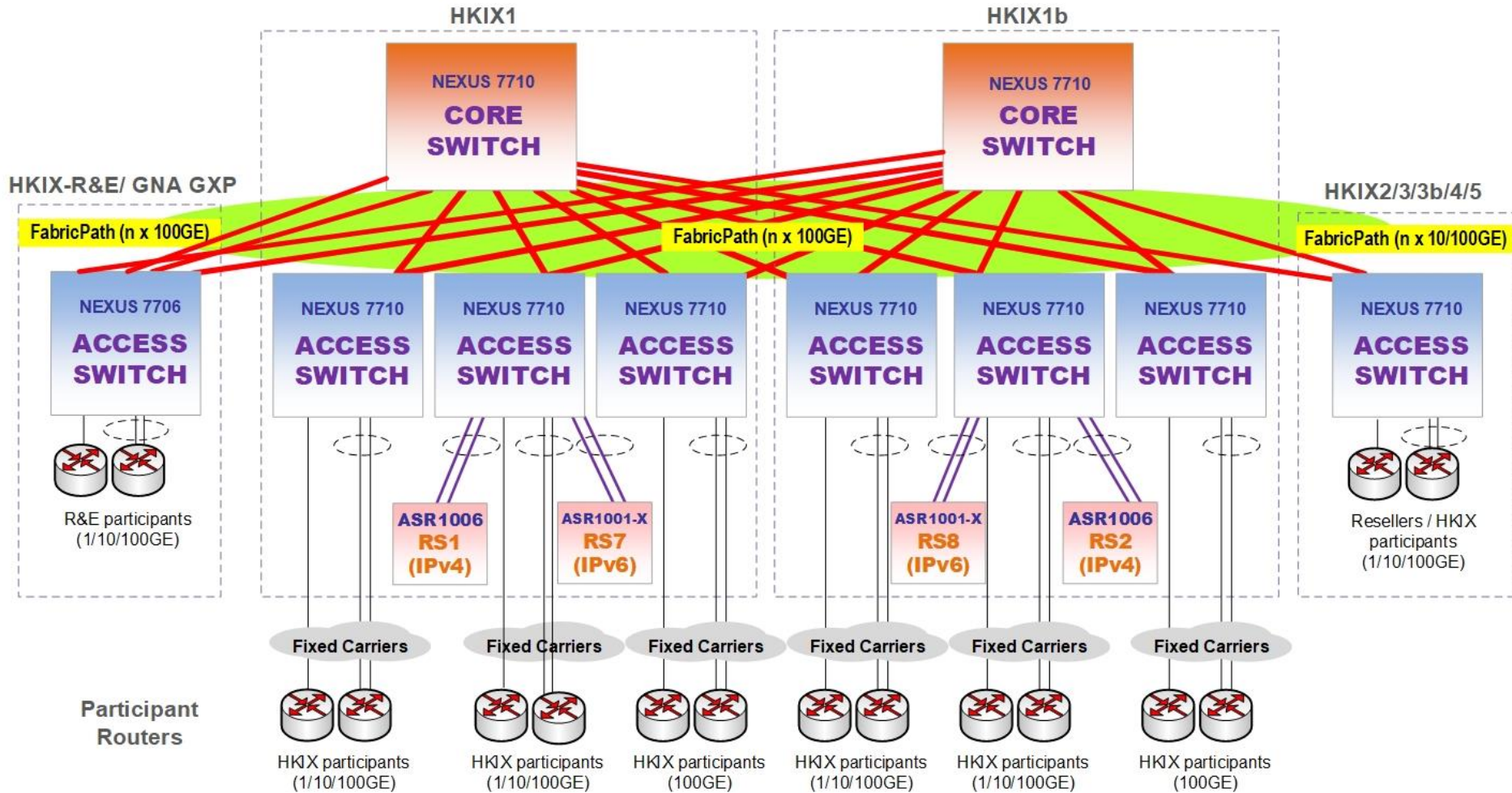

1. **HKIX1** and **HKIX1b** are the two core sites of HKIX at CUHK while **HKIX2/3/3b/4/5** are HKIX satellite sites outside of CUHK.
2. HKIX participants are encouraged to connect to multiple sites for site resilience.

# 100GE Connections at HKIX

## Latest Numbers of 100GE Ports Connected (2018 AUG - 2020 JUL)

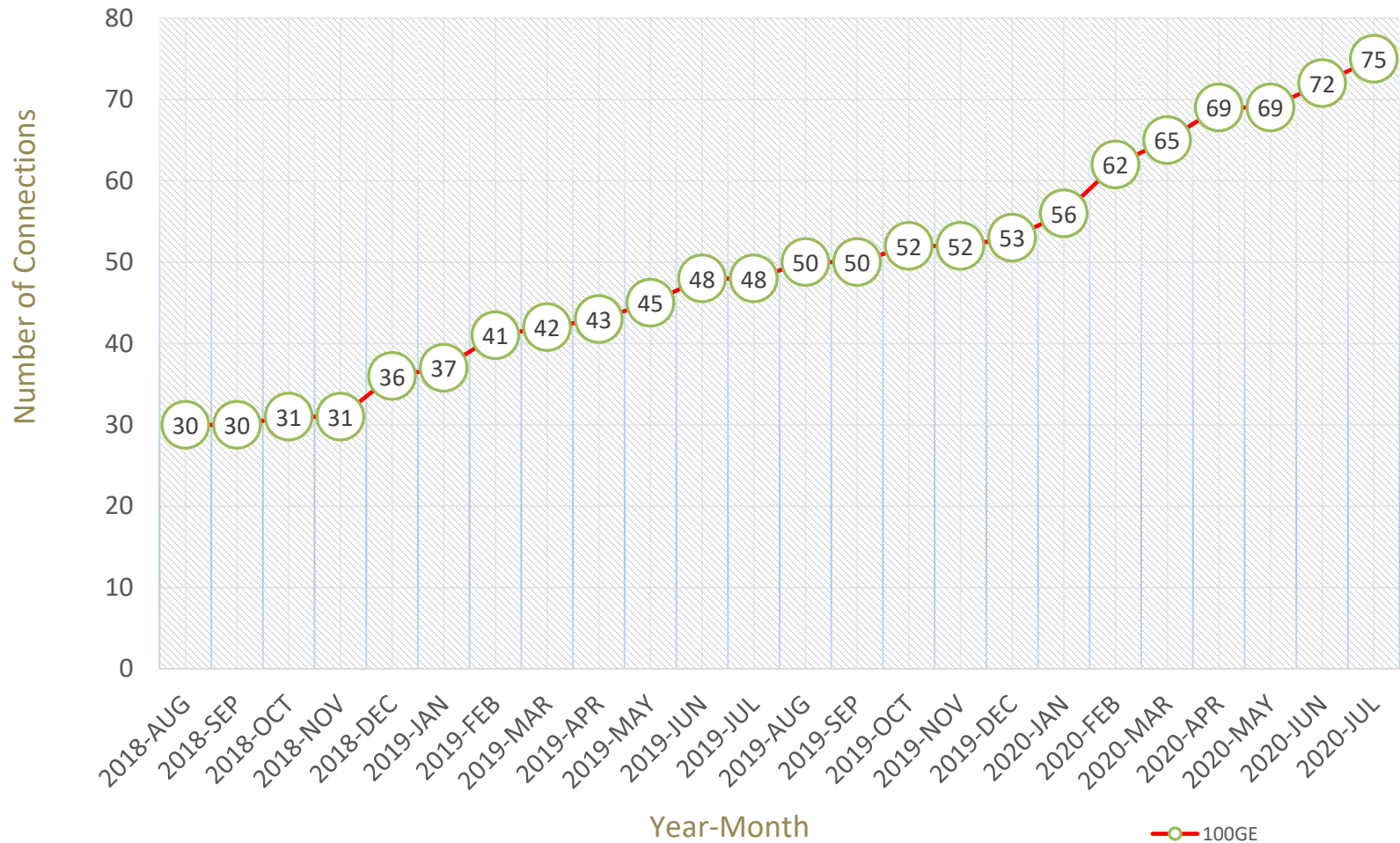



# HKIX 100GE Participants (1/3)

- Akamai
- Amazon
- ANSONNET
- AOFEI
- BGP Consultancy
- BIGO
- China Mobile HK
- China Mobile International
- CloudFlare
- Continent 8
- Facebook

# HKIX 100GE Participants (2/3)

- Google
- HKBN
- Hurricane Electric
- HGC
- PCCW
- Level 3
- Limelight
- Microsoft
- Mytek
- Netflix
- PCCW Global

# HKIX 100GE Participants (3/3)

- Taobao
- Telin
- Telstra
- Tencent
- TVB
- Udomain
- China Unicom HK
- Value
- XLC Global
- Yahoo

# HKIX's 100GE participants at a glance

<p><u>Content Provider</u></p> <p>BGP Network (M) Sdn Bhd</p>	<p><u>ISP Regional</u></p>	<p><u>ISP Local</u></p>	
<p><u>Retail &amp; Gaming</u></p>	<p><u>DDoS Provider</u></p>	<p><u>Data Centre</u></p>	<p><u>Others</u></p>



# HKIX-R&E – Special Support for R&E Networks Having Presence in HK

- HKIX helps those R&E Networks interconnect among themselves and with commercial networks without restrictions via HKIX-R&E switch at MEGA-i
- The main purpose is to facilitate those National R&E Networks having presence in Hong Kong to do interconnections among themselves \*and\* do peering with commercial networks at HKIX more easily and at a lower cost.
- Started in 2008
- **Free of charge** (no port charge on HKIX-R&E switch and the connection to HKIX)
- Support GE/10GE/100GE Trunk Ports for R&E networks
- Support Point-to-point VLANs for R&E networks
  - For private interconnections among any 2 R&E networks
  - Jumbo Frame support
- Fiber Cross Connect to be provided by R&E networks
- 7x24 NOC support
- Operate by HKIX with the HKIX-R&E switch at MEGA-i
- Support R&E equipment colocation at HKIX/CUHK

# HKIX-R&E Network Diagram

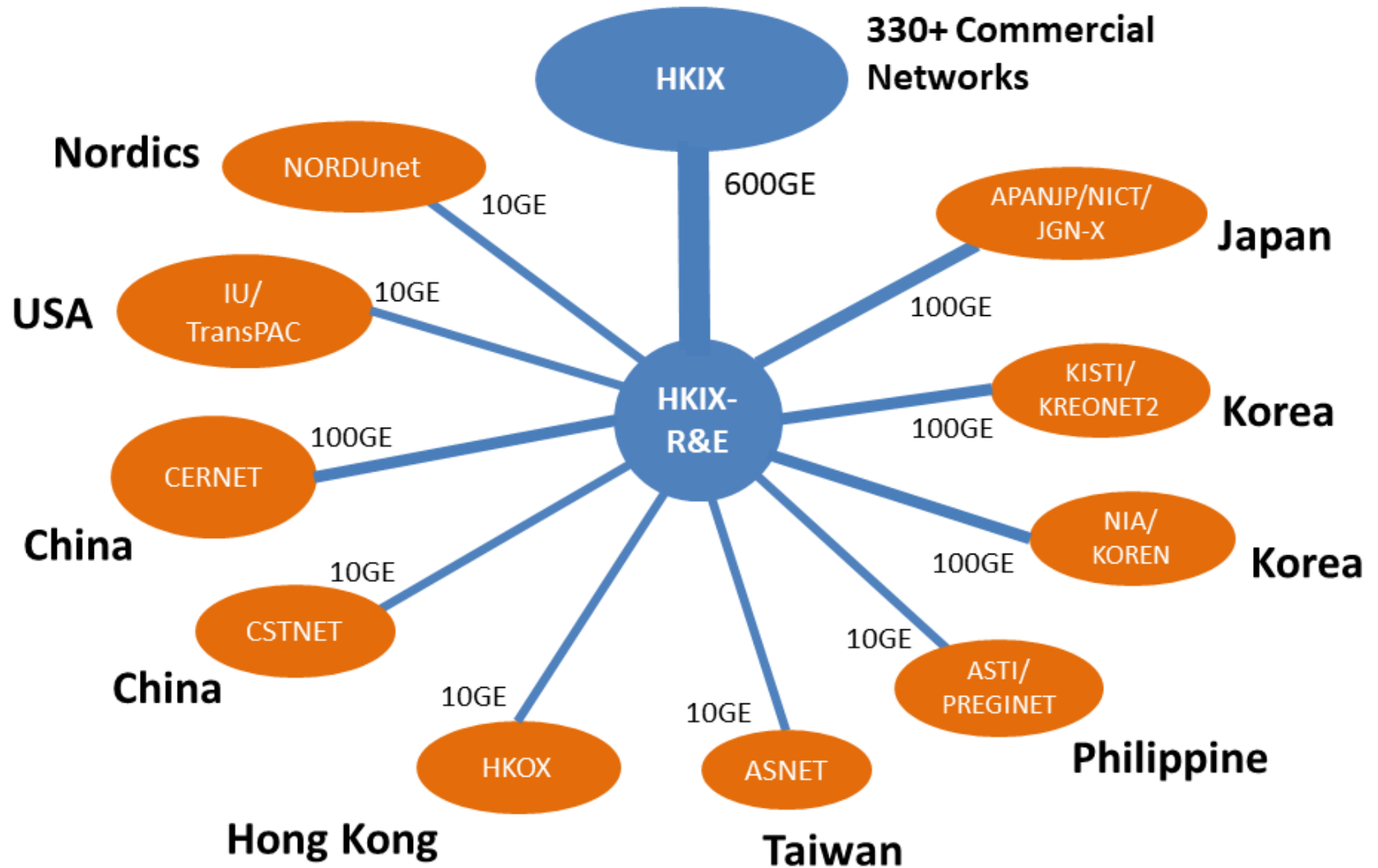

# HKIX-R&E Network Diagram

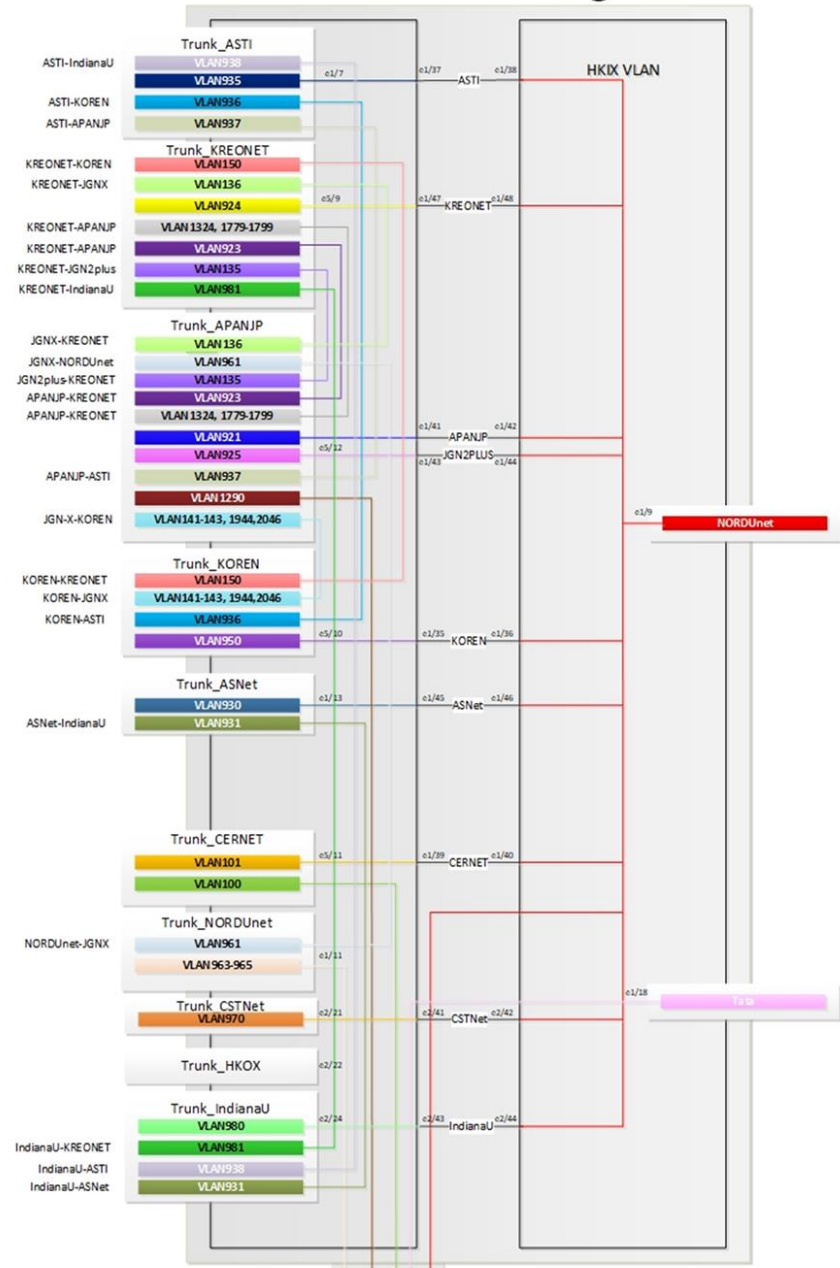

FabricPath  
To HKIX1/HKIX1b

# HKIX-R&E Updates

- NORDUnet connection upgraded to 10GE in Apr/2020
- HKIX perfSONAR server (perfsonar1b.hkix.net) is added to APAN MaDDash
  - IP address: 202.45.188.76
- Nx100G Connections from MEGA-i to HKIX
  - Upgraded to **600G** (6x100G) in May/2020
  - Will be upgraded to **800G** (8x100G) in Q4/2020



# HKIX-R&E Connections at MEGA-i



## **100GE :**

- APANJP / NICT / JGN-X
- CERNET
- NIA / KOREN
- KISTI / KREONET2

## **10GE :**

- ASNET
- ASTI / PREGINET
- CSTNET
- HKOX
- Indiana University / TransPAC
- NORDUnet



# HKIX perfSONAR Server

perfSONAR Toolkit on perfsonar1b.hkix.net

[Log in](#)

[Configuration](#)

[? Help](#)

**perfsonar1b.hkix.net** at 202.45.188.76 [Edit](#)

**Organization:** HKIX  
**Address:** HK HK ([map](#))  
**Administrator:** Ryan ([ryan@hkix.net](mailto:ryan@hkix.net))

## Services

SERVICE	STATUS	VERSION	PORTS
<a href="#">esmond</a> ▾	Running	4.2.1-1.e17	
<a href="#">lsregistration</a>	Running	4.2.1-1.e17	
<a href="#">owamp</a> ▾	Running	4.2.1-1.e17	861
<a href="#">pscheduler</a> ▾	Running	4.2.1-1.e17	
<a href="#">psconfig</a>	Running	4.2.1-1.e17	
<a href="#">twamp</a> ▾	Running	4.2.1-1.e17	862

Test Results (15 Results)

[Configure tests](#)

## Host Information [\(Log in for more info\)](#)

Interfaces [Details ▾](#)

Primary Interface em1

NTP Synced Yes

Globally Registered Yes

Node Role Exchange Point

Access Policy Public

Virtual Machine No

RAM 31 GB

More Info [Details ▾](#)

Communities

◦ 10G

## On-demand testing tools

[Reverse ping](#)

[Reverse traceroute](#)



# HKIX Infrastructure @MEGA-i

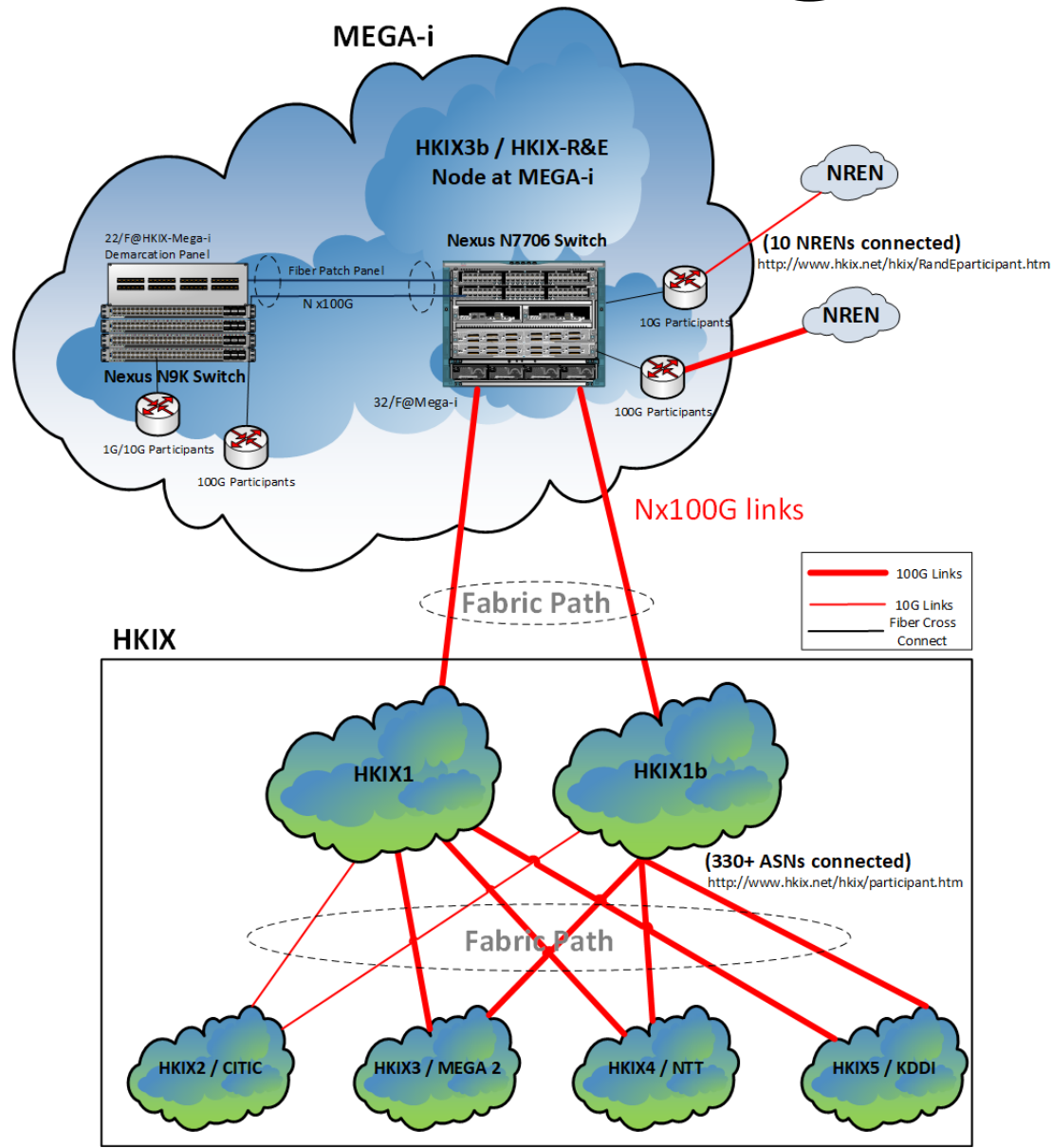

# HKIX Planned Works for 2020

- **Improved Stability**
  - Better Control of Proxy ARP
- **Improved Services**
  - Rollout portal for HKIX participants / R&E participants
  - True 24x7 NOC (both email & hotline support)
  - Improve after-hour support
  - Introduce advanced Route Server functions
  - perfSONAR server
  - Automatic network filter update (support updates from IRR)
  - **New HKIX Route Servers**
  - **NTP server for HKIX participants**
- **Improved Security**
  - ISO27001
  - Better support for DDoS mitigation
  - Implement RPKI on HKIX Route Servers to enhance routing security
  - **Implement MANRS IXP Programme for routing security**
  - **Implement security operations center (SOC)**

# HKIX Future Upgrade Plan

- Support of 400G connections
- Network traffic visibility
- Network automation
- VXLAN EVPN Multi-Site Deployment
  - Multiple vendors support
  - Unknown unicast suppression
  - VLAN translation

IX name	Hong Kong Internet eXchange (HKIX)
City, Country	Hong Kong
Point of Presence	<b>Core Sites:</b> <b>HKIX1 &amp; HKIX1b</b> @CUHK  <b>HKIX-R&amp;E:</b> HKIX-R&E@MEGA-i  <b>Satellite Sites:</b> <b>HKIX2</b> @CITIC, <b>HKIX3/HKIX3b</b> @iAdvantage, <b>HKIX4</b> @NTT, <b>HKIX5</b> @KDDI
# of connected ASN	334
Peak traffic	1.77Tbps
Route Servers	Yes, IPv4 & IPv6 (Cisco ASR1006 & ASR1002-HX)
Remarks	Website: <a href="https://www.hkix.net">https://www.hkix.net</a> PeeringDB: <a href="https://www.peeringdb.com/ix/42">https://www.peeringdb.com/ix/42</a>

For enquiries, please email us at [info@hkix.net](mailto:info@hkix.net)

# Thank You!

For enquiries, please contact us at  
info [at] hkix.net